

A D V A N C E D

Catalogue
2021

ITA/ENG



alba components

A D V A N C E D

Collection
2021

— new product



58

aria



230

bases



249

bench components



206

coat hangers



236

components



160

duetto



52

e.usb



38

feel



216

foot rings &
columns



144

logan

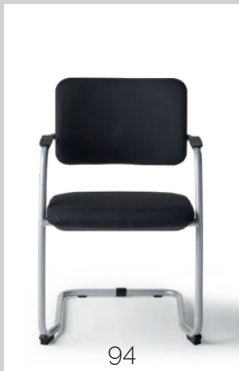

94

magix



172

manila

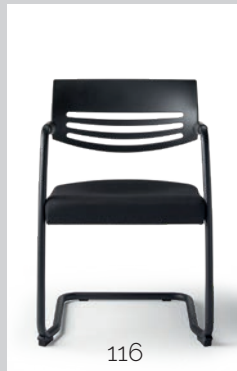

116

moon



66

nexus



182

pluto



76

siton

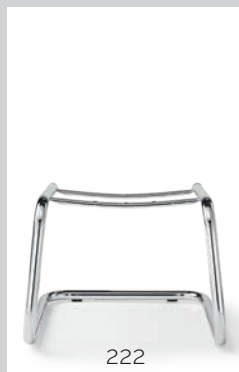

222

slide bases



124

spot



130

square

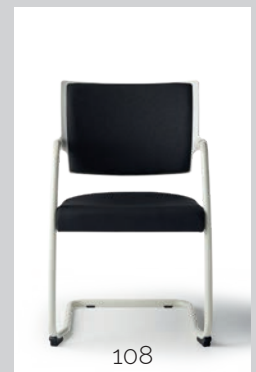

108

starlight



8

tapas



196

teddy



20

tipper



26

wing

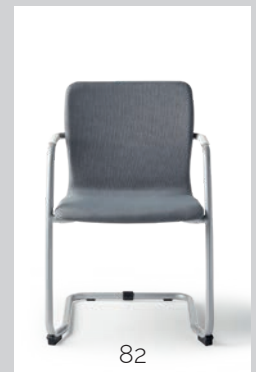

82

young/key/fabric

A D V A N C E D

Catalogue 2021

I nuovi strumenti di vendita **AlbaComponents** sono stati sviluppati in coerenza al **concept di comunicazione Evolution**, per raccontare i valori dell'azienda e i pillars su cui fonda il suo operato, al fine di proporre un'offerta unica e distintiva.

Per il **2021** la scelta è stata di proporre **due cataloghi: Originally e Advanced**. Le proposte **AlbaComponents** più storiche sono state divise da quelle più recenti, al fine di favorire un più semplice utilizzo degli strumenti da parte dei nostri clienti.

Il bruco e la farfalla del concept **Evolution** raccontano **l'importante evoluzione che l'azienda**, trasformando con sapienza la materia prima, **è riuscita a compiere** per garantire un'offerta sempre distintiva, unica, evoluta.

*The new **AlbaComponents** sales instruments have been developed to be coherent with the **Evolution communication concept**, to convey the company's values and the pillars upon which its approach to operations are based, with the aim of ensuring what we offer is both unique and distinctive.*

*For **2021** we've decided to publish **two catalogues: Originally and Advanced**. We've divided the more historic range of **AlbaComponents** for our more recent products, to make it easier for our clients to use these instruments.*

***The caterpillar and the butterfly** of the **Evolution** concept symbolise **the major evolution the company has managed to complete** by expertly transforming raw materials into an offer which is always guaranteed to be distinctive, unique and evolved.*

#Solutions

#Logistic

L'**ala superiore** rappresenta il **Servizio al cliente** inteso sia come capacità di offrire soluzioni complete nelle **varie versioni di prodotto** e per tanto estremamente versatili **#Solutions** sia come **servizio logistico** efficace e puntuale per il cliente AlbaComponents **#Logistic**.

the **Evolution** concept

The **upper wing** stands for **Customer service** meaning both the ability to offer complete solutions in the **various versions of the product** and therefore extremely versatile **#Solutions** and the effective and punctual **logistics service** AlbaComponents' offers its customers **#Logistic**.

#Innovation

#Design

Le **antenne** rappresentano il costante monitoraggio del mercato, come strumento del reparto **Ricerca & Sviluppo** per proporre soluzioni funzionali e innovative, sia per soddisfare le richieste attuali sia per **anticipare le tendenze future**.

The **antennae** symbolise our constant monitoring of the market, a tool which our **Research & Development** department uses to propose functional and innovative solutions to meet both current demands as well as **anticipate future trends**.

#Sustainability

L'**ala inferiore** rappresenta invece l'**attenzione sociale** intesa sia come **Azioni Sostenibili** a tutela dell'ambiente e delle persone sia come **sostegno del territorio** e **sponsorizzazione** delle attività sportive giovanili.

The **lower wing** represents **social awareness**, meaning both **Sustainable Actions** to safeguard the environment and the people who live in it, as well as **support for our local community** and **sponsorship** of youth sports activities.

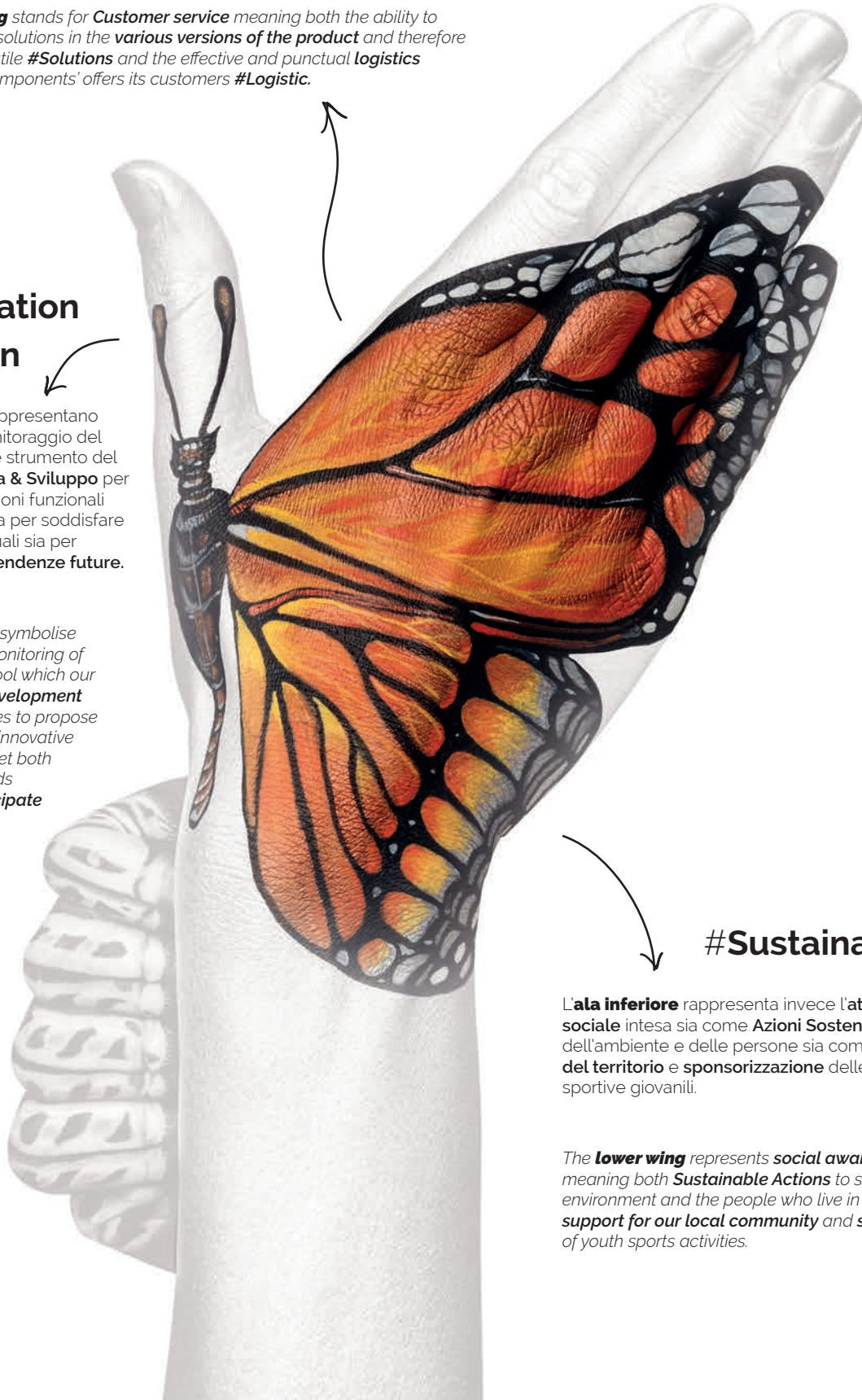

albacomponents

Il **catalogo Advanced** raccoglie l'offerta più avanzata di **AlbaComponents**, risultato dell'importante e continuo percorso evolutivo del marchio.

Al suo interno sono presenti le soluzioni d'arredo più recenti, innovative ed ecosostenibili che meglio rappresentano il concept aziendale e i pillars:

#Innovation

#Design

#Sustainability

*The **Advanced catalogue** gathers together the most advanced **AlbaComponents** products, the culmination of the major and ongoing evolution of the brand.*

Inside, you will find the latest, most innovative and eco-friendly furnishing solutions, which best exemplify the company concept and the pillars:

#Innovation

#Design

#Sustainability



#Innovation



#Design



#Sustainability



BEYOND | **Design**

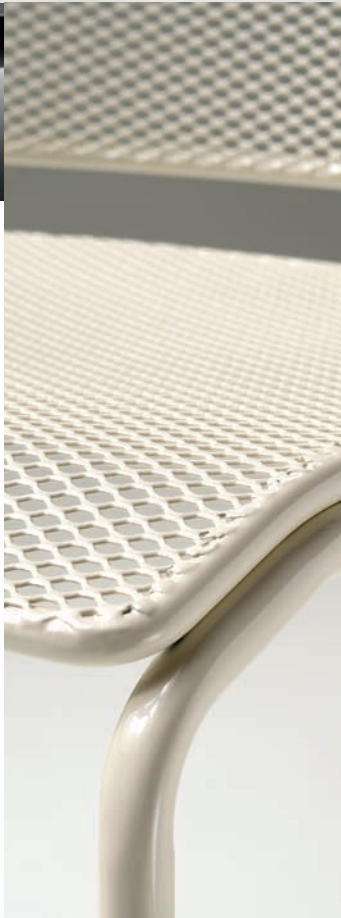



tapas



tapas



stool

high table

low table

coffee table

metal slide
metal 4-legs
metal stool

tapas showing



tools



brochure

features



designed by:
edi & paolo ciani design



outdoor
ready



La nuova linea per l'ambiente Ho.re.ca.

Una collezione innovativa e completa, che si sviluppa in due famiglie. La prima, per uso **indoor & outdoor**, è completamente smontabile, pratica nell'assemblaggio e di grande solidità, con un design funzionale e versatile grazie alle numerose varianti di finitura. La seconda è pensata **appositamente per l'outdoor**, con telai dedicati e finiture dei materiali ideali per questo tipo di utilizzo.

Plus di utilizzo:

- numerose varianti di finitura;
- versatilità nell'utilizzo grazie alle specifiche finiture per l'outdoor;
- i kit della famiglia indoor & outdoor prevedono un imballo smontato per ridurre i costi di movimentazione;
- semplice da assemblare.

Tapas è ideale per l'ambiente Contract.

The new product line for the Ho.re.ca environment.

*An innovative and complete collection that is divided into two families. The first, for **indoor & outdoor** use, can be completely disassembled, is easy to assemble and is very solid, with a functional and versatile design due to its numerous finish variations. The second is designed **specifically for outdoor use**, with dedicated frames and material finishes that are ideal for this type of use.*

Advantages:

- numerous finish variations;
- versatility in its use due to the specific finishes for outdoor use;
- the indoor & outdoor family kits come in a disassembled package to reduce handling costs;
- easy to assemble.

Tapas is ideal for the **Contract** environment.

tapas

stool

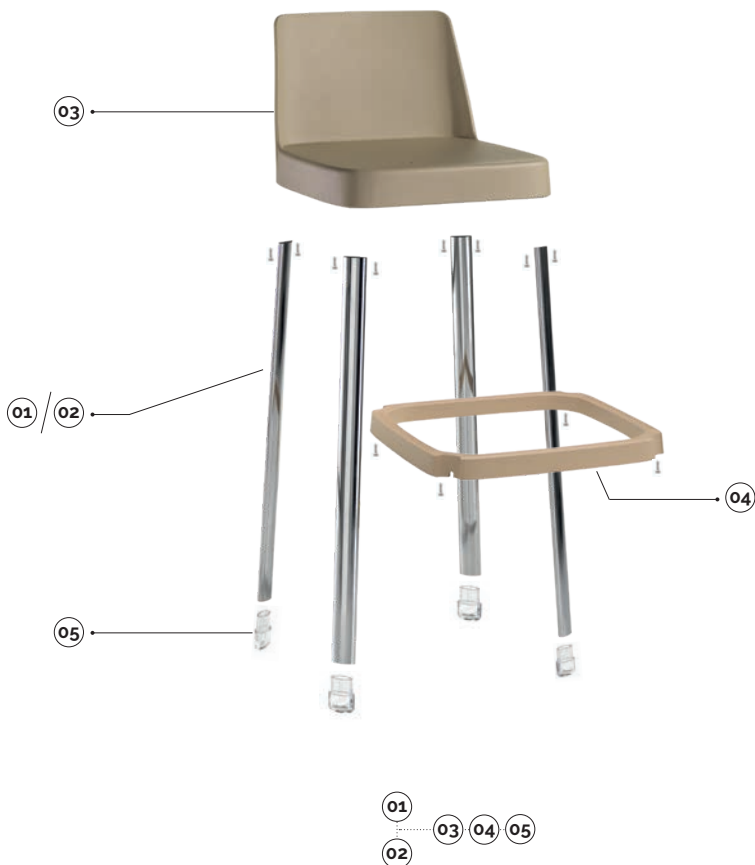

plastic colours

- avorio/ivory ral1013
- nocciola/hazelnut 2312u
- grigio/grey ig2621
- nero/black ral9005

Corten ● *Specifica caratteristica del Corten è la variabilità nella tonalità della finitura.
* A specific characteristic of Corten is the variability in the tone of the finish.

main component sizes

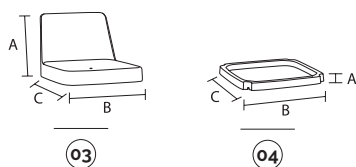
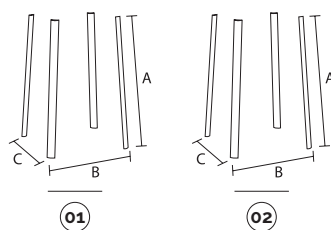

01 tapas-sgabello h650 kit n'4 gambe con viti tapas-kit stool h650 n'4 legs with screws

code	finishing	q.kit	q.pack	a	b	c	kg.x1	vol.x1
110603-637	● nero/black	x1	5	650	410	410	3.54	mc. 0.0035
110604-637	● grigio/grey ig2621	x1	5	650	410	410	3.54	mc. 0.0035
110605-637	● avorio/ivory ral 1013	x1	5	650	410	410	3.54	mc. 0.0035
110607-637	● corten*	x1	5	650	410	410	3.54	mc. 0.0035
110610-637	● cromato/chrome	x1	5	650	410	410	3.54	mc. 0.0035
110603-638	● nero/black	x1	5	650	410	410	3.54	mc. 0.0035
110604-638	● grigio/grey ig2621	x1	5	650	410	410	3.54	mc. 0.0035
110605-638	● avorio/ivory ral 1013	x1	5	650	410	410	3.54	mc. 0.0035
110607-638	● corten*	x1	5	650	410	410	3.54	mc. 0.0035

02 tapas-sgabello h750 kit n'4 gambe con viti tapas-kit stool h750 n'4 legs with screws

code	finishing	q.kit	q.pack	a	b	c	kg.x1	vol.x1
110603-635	● nero/black	x1	5	750	422	422	3.54	mc. 0.0035
110604-635	● grigio/grey ig2621	x1	5	750	422	422	3.54	mc. 0.0035
110605-635	● avorio/ivory ral 1013	x1	5	750	422	422	3.54	mc. 0.0035
110607-635	● corten*	x1	5	750	422	422	3.54	mc. 0.0035
110610-635	● cromato/chrome	x1	5	750	422	422	3.54	mc. 0.0035
110603-636	● nero/black	x1	5	750	422	422	3.54	mc. 0.0035
110604-636	● grigio/grey ig2621	x1	5	750	422	422	3.54	mc. 0.0035
110605-636	● avorio/ivory ral 1013	x1	5	750	422	422	3.54	mc. 0.0035
110607-636	● corten*	x1	5	750	422	422	3.54	mc. 0.0035

03 tapas-scocca seduta sgabello tapas-stool plastic shell

code	finishing	q.kit	q.pack	a	b	c	kg.x1	vol.x1
130603-003	● nero/black	x1	5	276	382	458	2.06	mc. 0.02045
130604-001	● grigio/grey 650	x1	5	276	382	458	2.06	mc. 0.02045
130605-003	● avorio/ivory ral 1013	x1	5	276	382	458	2.06	mc. 0.02045
130607-003	● nocciola/hazelnut 2312u	x1	5	276	382	458	2.06	mc. 0.02045

04 tapas-poggiapiedi sgabello tapas-stool footrest

code	finishing	q.kit	a	b	c	kg.x1		
130603-000	● nero/black	x1	5	34	417	417	0.874	mc. 0.01092
130604-000	● grigio/grey 650	x1	5	34	417	417	0.874	mc. 0.01092
130605-002	● avorio/ivory ral 1013	x1	5	34	417	417	0.874	mc. 0.01092
130607-000	● nocciola/hazelnut 2312u	x1	5	34	417	417	0.874	mc. 0.01092

05 tapas-piedino ellittico 40x20 h30 tapas-elliptical glide 40x20 h30

code	finishing	q.kit	kg.x1	
134303-045	● nero/black	x4	0.0174	mc. 0.00003
134306-005	○ trasparente/transparent	x4	0.0174	mc. 0.00003

tapas

high table

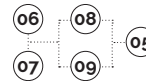
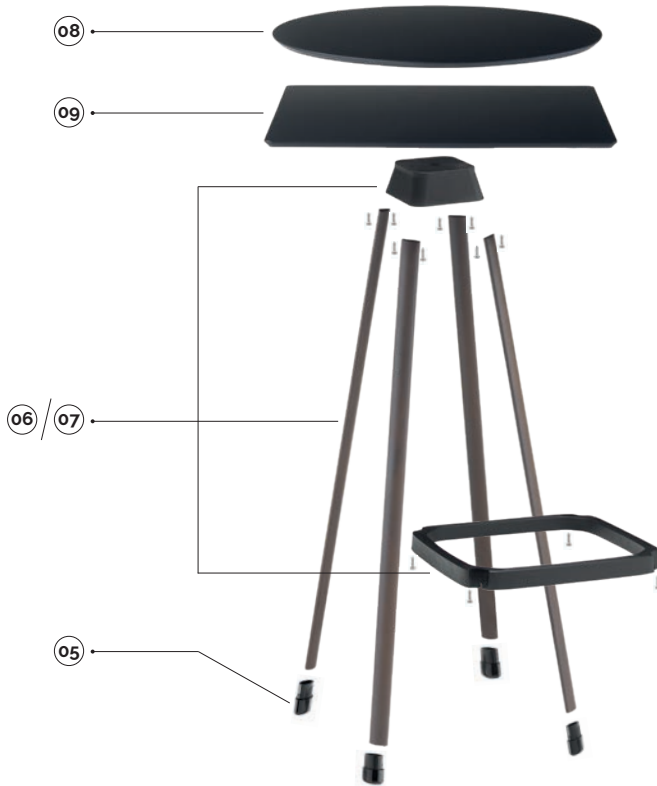

Si consigliano le seguenti misure di top:
The following top measures are recommended:

- high table: 590 / 690 mm

plastic colours

- avorio/ivory ral1013
- nero/black ral9005

Corten
*Specifica caratteristica del Corten è la variabilità nella tonalità della finitura.
* A specific characteristic of Corten is the variability in the tone of the finish.

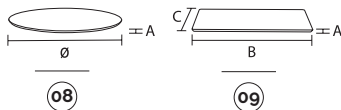
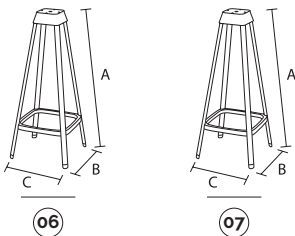

main component sizes

06 tapas-kit gambe tavolo alto con viti + supporto + poggiatesta avorio r1013

tapas-kit high table legs with screws + table frame + footrest ivory r1013

code	finishing	q.kit	q.pack	a	b	c	kg.x1	vol.x1
110303-244	● nero/black	x1	2	1085	453	453	8,0	mc. 0.02365
110304-244	● grigio/grey ig2621	x1	2	1085	453	453	8,0	mc. 0.02365
110305-244	● avorio/ivory ral 1013	x1	2	1085	453	453	8,0	mc. 0.02365
110307-244	● corten*	x1	2	1085	453	453	8,0	mc. 0.02365
110310-244	● cromato/chrome	x1	2	1085	453	453	8,0	mc. 0.02365
110303-246	● nero/black	*per esterno/outdoor	x1	2	1085	453	8,0	mc. 0.02365
110304-246	● grigio/grey ig2621	*per esterno/outdoor	x1	2	1085	453	8,0	mc. 0.02365
110305-246	● avorio/ivory ral 1013	*per esterno/outdoor	x1	2	1085	453	8,0	mc. 0.02365
110307-246	● corten*	*per esterno/outdoor	x1	2	1085	453	8,0	mc. 0.02365

07 tapas-kit gambe tavolo alto con viti + supporto + poggiatesta nero

tapas-kit high table legs with screws + table frame + footrest black

code	finishing	q.kit	q.pack	a	b	c	kg.x1	vol.x1
110303-245	● nero/black	x1	2	1085	453	453	8,0	mc. 0.02365
110304-245	● grigio/grey ig2621	x1	2	1085	453	453	8,0	mc. 0.02365
110305-245	● avorio/ivory ral 1013	x1	2	1085	453	453	8,0	mc. 0.02365
110307-245	● corten*	x1	2	1085	453	453	8,0	mc. 0.02365
110310-245	● cromato/chrome	x1	2	1085	453	453	8,0	mc. 0.02365
110303-247	● nero/black	*per esterno/outdoor	x1	2	1085	453	8,0	mc. 0.02365
110304-247	● grigio/grey ig2621	*per esterno/outdoor	x1	2	1085	453	8,0	mc. 0.02365
110305-247	● avorio/ivory ral 1013	*per esterno/outdoor	x1	2	1085	453	8,0	mc. 0.02365
110307-247	● corten*	*per esterno/outdoor	x1	2	1085	453	8,0	mc. 0.02365

08 tapas-top rotondo + viti

tapas-round top + screws

code	finishing	q.kit	q.pack	a	ø	kg.x1	vol.x1
120303-004	● nero/black	x1	5	12	590	4,8	mc. 0.0072
120303-005	● nero/black	x1	5	12	690	6,6	mc. 0.0098
120303-006	● nero/black	x1	5	12	790	8,4	mc. 0.0128
120305-004	● avorio/ivory ral 1013	x1	5	12	590	4,8	mc. 0.0072
120305-005	● avorio/ivory ral 1013	x1	5	12	690	6,6	mc. 0.0098
120305-006	● avorio/ivory ral 1013	x1	5	12	790	8,4	mc. 0.0128

09 tapas-top quadrato + viti

tapas-square top + screws

code	finishing	q.kit	q.pack	a	b	c	kg.x1	vol.x1
120303-008	● nero/black	x1	5	12	590	590	6,0	mc. 0.0072
120303-009	● nero/black	x1	5	12	690	690	8,2	mc. 0.0098
120303-010	● nero/black	x1	5	12	790	790	10,7	mc. 0.0128
120305-008	● avorio/ivory ral 1013	x1	5	12	590	590	6,0	mc. 0.0072
120305-009	● avorio/ivory ral 1013	x1	5	12	690	690	8,2	mc. 0.0098
120305-010	● avorio/ivory ral 1013	x1	5	12	790	790	10,7	mc. 0.0128

05 tapas-piedino ellittico 40x20 h30

tapas-elliptical glide 40x20 h30

code	finishing	q.kit	kg.x1
134303-045	● nero/black	x4	0,0174 mc. 0.00003
134306-005	○ trasparente/transparent	x4	0,0174 mc. 0.00003



tapas

low table

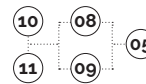
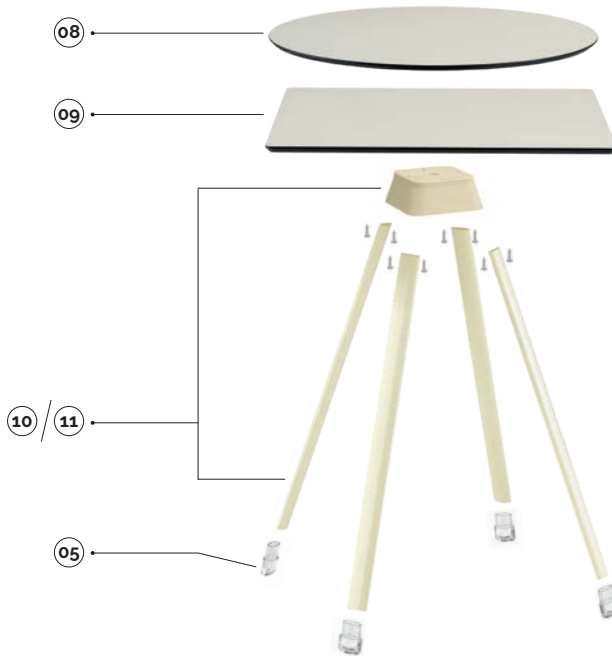

Si consigliano le seguenti misure di top:
The following top measures are recommended:

- low table: 690/ 790 mm

plastic colours

- avorio/ivory ral1013
- nero/black ral9005

Corten
* Specifica caratteristica del Corten è la variabilità nella tonalità della finitura.
* A specific characteristic of Corten is the variability in the tone of the finish.

main component sizes

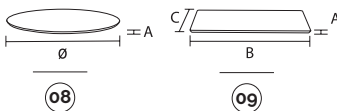
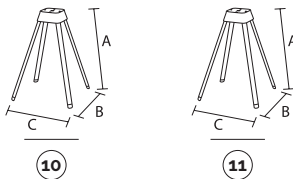

10 tapas-kit gambe tavolo basso con viti + supporto avorio r1013

tapas-kit low table legs with screws + table frame ivory r1013

code	finishing	q.kit	q.pack	a	b	c	kg.x1	vol.x1
110303-240	● nero/black	x1	2	730	530	530	5.11	mc. 0.01155
110304-240	● grigio/grey ig2621	x1	2	730	530	530	5.11	mc. 0.01155
110305-240	● avorio/ivory ral 1013	x1	2	730	530	530	5.11	mc. 0.01155
110307-240	● corten*	x1	2	730	530	530	5.11	mc. 0.01155
110310-240	● cromato/chrome	x1	2	730	530	530	5.11	mc. 0.01155
110303-242	● nero/black	x1	2	730	530	530	5.11	mc. 0.01155
110304-242	● grigio/grey ig2621	x1	2	730	530	530	5.11	mc. 0.01155
110305-242	● avorio/ivory ral 1013	x1	2	730	530	530	5.11	mc. 0.01155
110307-242	● corten*	x1	2	730	530	530	5.11	mc. 0.01155

11 tapas-kit gambe tavolo basso con viti + supporto nero

tapas-kit low table legs with screws + table frame black

code	finishing	q.kit	q.pack	a	b	c	kg.x1	vol.x1
110303-241	● nero/black	x1	2	730	530	530	5.11	mc. 0.01155
110304-241	● grigio/grey ig2621	x1	2	730	530	530	5.11	mc. 0.01155
110305-241	● avorio/ivory ral 1013	x1	2	730	530	530	5.11	mc. 0.01155
110307-241	● corten*	x1	2	730	530	530	5.11	mc. 0.01155
110310-241	● cromato/chrome	x1	2	730	530	530	5.11	mc. 0.01155
110303-243	● nero/black	x1	2	730	530	530	5.11	mc. 0.01155
110304-243	● grigio/grey ig2621	x1	2	730	530	530	5.11	mc. 0.01155
110305-243	● avorio/ivory ral 1013	x1	2	730	530	530	5.11	mc. 0.01155
110307-243	● corten*	x1	2	730	530	530	5.11	mc. 0.01155

08 tapas-top rotondo + viti

tapas-round top + screws

code	finishing	q.kit	q.pack	a	ø	kg.x1	vol.x1
120303-004	● nero/black	x1	5	12	590	4.8	mc. 0.0072
120303-005	● nero/black	x1	5	12	690	6.6	mc. 0.0098
120303-006	● nero/black	x1	5	12	790	8.4	mc. 0.0128
120305-004	● avorio/ivory ral 1013	x1	5	12	590	4.8	mc. 0.0072
120305-005	● avorio/ivory ral 1013	x1	5	12	690	6.6	mc. 0.0098
120305-006	● avorio/ivory ral 1013	x1	5	12	790	8.4	mc. 0.0128

09 tapas-top quadrato + viti

tapas-square top + screws

code	finishing	q.kit	q.pack	a	b	c	kg.x1	vol.x1
120303-008	● nero/black	x1	5	12	590	590	6.0	mc. 0.0072
120303-009	● nero/black	x1	5	12	690	690	8.2	mc. 0.0098
120303-010	● nero/black	x1	5	12	790	790	10.7	mc. 0.0128
120305-008	● avorio/ivory ral 1013	x1	5	12	590	590	6.0	mc. 0.0072
120305-009	● avorio/ivory ral 1013	x1	5	12	690	690	8.2	mc. 0.0098
120305-010	● avorio/ivory ral 1013	x1	5	12	790	790	10.7	mc. 0.0128

05 tapas-piedino ellittico 40x20 h30

tapas-elliptical glide 40x20 h30

code	finishing	q.kit	kg.x1
134303-045	● nero/black	x4	0.0174 mc. 0.00003
134306-005	○ trasparente/transparent	x4	0.0174 mc. 0.00003

tapas

coffee table

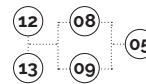
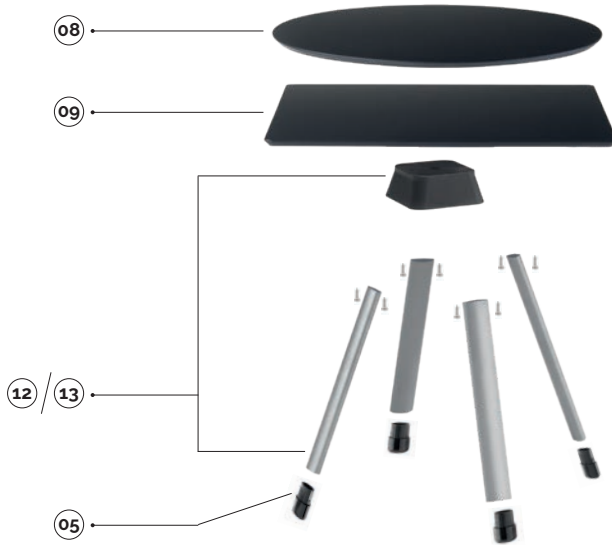

Si consigliano le seguenti misure di top:
The following top measures are recommended:

- coffee table: 590 mm

plastic colours

- avorio/ivory ral1013
- nero/black ral9005

Corten
* Specifica caratteristica del Corten è la variabilità nella tonalità della finitura.
* A specific characteristic of Corten is the variability in the tone of the finish.

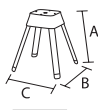
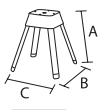

12

13

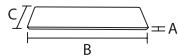
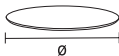

08

09

main component sizes



12 tapas-kit gambe tavolo caffè' con viti + supporto avorio r1013 tapas-kit coffee table legs with screws + table frame ivory r1013

code	finishing	q.kit	q.pack	a	b	c	kg.x1	vol.x1
110303-248	● nero/black	x1	2	390	353	353	2,92	mc. 0.006405
110304-248	● grigio/grey ig2621	x1	2	390	353	353	2,92	mc. 0.006405
110305-248	● avorio/ivory ral 1013	x1	2	390	353	353	2,92	mc. 0.006405
110307-248	● corten*	x1	2	390	353	353	2,92	mc. 0.006405
110310-248	● cromato/chrome	x1	2	390	353	353	2,92	mc. 0.006405
110303-250	● nero/black *per esterno/outdoor	x1	2	390	353	353	2,92	mc. 0.006405
110304-250	● grigio/grey ig2621 *per esterno/outdoor	x1	2	390	353	353	2,92	mc. 0.006405
110305-250	● avorio/ivory ral 1013 *per esterno/outdoor	x1	2	390	353	353	2,92	mc. 0.006405
110307-250	● corten* *per esterno/outdoor	x1	2	390	353	353	2,92	mc. 0.006405

13 tapas-kit gambe tavolo caffè' con viti + supporto nero tapas-kit coffee table legs with screws + table frame black

code	finishing	q.kit	q.pack	a	b	c	kg.x1	vol.x1
110303-249	● nero/black	x1	2	390	353	353	2,92	mc. 0.006405
110304-249	● grigio/grey ig2621	x1	2	390	353	353	2,92	mc. 0.006405
110305-249	● avorio/ivory ral 1013	x1	2	390	353	353	2,92	mc. 0.006405
110307-249	● corten*	x1	2	390	353	353	2,92	mc. 0.006405
110310-249	● cromato/chrome	x1	2	390	353	353	2,92	mc. 0.006405
110303-251	● nero/black *per esterno/outdoor	x1	2	390	353	353	2,92	mc. 0.006405
110304-251	● grigio/grey ig2621 *per esterno/outdoor	x1	2	390	353	353	2,92	mc. 0.006405
110305-251	● avorio/ivory ral 1013 *per esterno/outdoor	x1	2	390	353	353	2,92	mc. 0.006405
110307-251	● corten* *per esterno/outdoor	x1	2	390	353	353	2,92	mc. 0.006405

08 tapas-top rotondo + viti tapas-round top + screws

code	finishing	q.kit	q.pack	a	ø	kg.x1	vol.x1
120303-004	● nero/black	x1	5	12	590	4,8	mc. 0.0072
120303-005	● nero/black	x1	5	12	690	6,6	mc. 0.0098
120303-006	● nero/black	x1	5	12	790	8,4	mc. 0.0128
120305-004	● avorio/ivory ral 1013	x1	5	12	590	4,8	mc. 0.0072
120305-005	● avorio/ivory ral 1013	x1	5	12	690	6,6	mc. 0.0098
120305-006	● avorio/ivory ral 1013	x1	5	12	790	8,4	mc. 0.0128

09 tapas-top quadrato + viti tapas-square top + screws

code	finishing	q.kit	q.pack	a	b	c	kg.x1	vol.x1
120303-008	● nero/black	x1	5	12	590	590	6,0	mc. 0.0072
120303-009	● nero/black	x1	5	12	690	690	8,2	mc. 0.0098
120303-010	● nero/black	x1	5	12	790	790	10,7	mc. 0.0128
120305-008	● avorio/ivory ral 1013	x1	5	12	590	590	6,0	mc. 0.0072
120305-009	● avorio/ivory ral 1013	x1	5	12	690	690	8,2	mc. 0.0098
120305-010	● avorio/ivory ral 1013	x1	5	12	790	790	10,7	mc. 0.0128

05 tapas-piedino ellittico 40x20 h30 tapas-elliptical glide 40x20 h30

code	finishing	q.kit	kg.x1
134303-045	● nero/black	x4	0,0174 mc. 0.00003
134306-005	○ trasparente/transparent	x4	0,0174 mc. 0.00003

tapas

4-legs/metal shell



14 15 16

Corten ● *Specifica caratteristica del Corten è la variabilità nella tonalità della finitura.
* A specific characteristic of Corten is the variability in the tone of the finish.

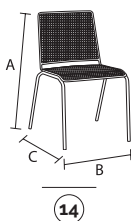

main component sizes

14 tapas-4 gambe con scocca in rete
tapas-4 legs with expanded metal shell

code	finishing		q.kit	q.pack	a	b	c	kg.x1	vol.x1
110105-367	● avorio/ivory	rat.1013 'per esterno/outdoor	x1	1	805	535	580	5,6	mc. 0.024
110107-367	● corten*	'per esterno/outdoor	x1	1	805	535	580	5,6	mc. 0.024

15 confezione puntali tondi d.18 neri
black inner round caps d.18 package

code	finishing	q.kit	q.pack
137003-072	● nero/black	x4	200

16 paracolpi testa piatta duro 12x3,8x6x9 neutro
flat head buffer 12x3,8x6x9 neutral

code	finishing	q.kit
134006-100	○ neutro/neutral	x4

tapas

stool/metal shell



17 15 16

Corten • *Specifica caratteristica del Corten è la variabilità nella tonalità della finitura.
* A specific characteristic of Corten is the variability in the tone of the finish.

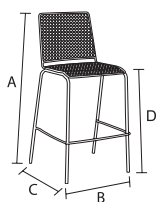

17

main component sizes

17 tapas-sgabello h750 con scocca in rete
tapas-stool h750 with expanded metal shell

code	finishing		q.kit	q.pack	a	b	c	d	kg.x1	vol.x1
110105-374	● avorio/ivory	ral.1013 *per esterno/outdoor	x1	1	1100	540	540	750	7,8	mc. 0,048
110107-374	● corten*	*per esterno/outdoor	x1	1	1100	540	540	750	7,8	mc. 0,048

15 confezione puntali tondi d.18 neri
black inner round caps d.18 package

code	finishing	q.kit	q.pack
137003-072	● nero/black	x4	200

16 paracolpi testa piatta duro 12x3,8x6x9 neutro
flat head buffer 12x3,8x6x9 neutral

code	finishing	q.kit
134006-100	○ neutro/neutral	x4

tapas

slide/metal shell

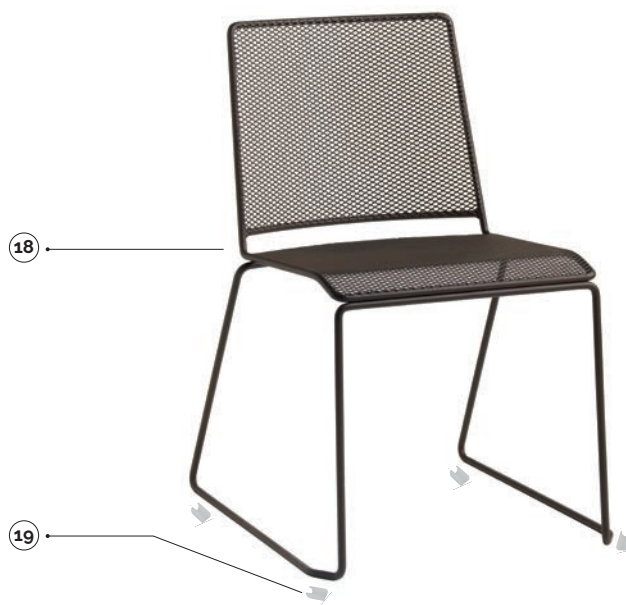

18 19

Corten ● *Specifica caratteristica del Corten è la variabilità nella tonalità della finitura.
* A specific characteristic of Corten is the variability in the tone of the finish.

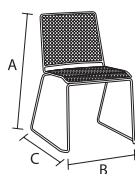

18

main component sizes

18 tapas-telaio a slitta in tondino d.12 con scocca in rete
tapas-slide wire frame d.12 with expanded metal shell

code	finishing		q.kit	q.pack	a	b	c	kg.x1	vol.x1
110505-504	● avorio/ivory	ral1013 *per esterno/outdoor	x1	1	805	520	595	7.7	mc. 0.036
110507-504	● corten*	*per esterno/outdoor	x1	1	805	520	595	7.7	mc. 0.036

19 confezione di basi a pinza antirotazione per tondino colore neutro
neutral clips base for wire d.11 package

code	finishing	q.kit	q.pack
137006-070	○ neutro/neutral	x4	200





BEYOND **Innovation**





tipper



tipper



components

tipper

components

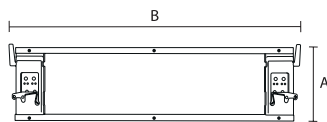
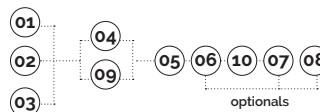

01 02 03

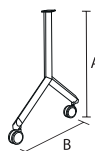

04

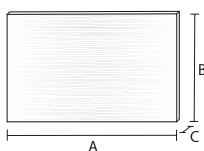

05

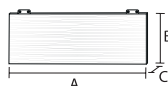

06

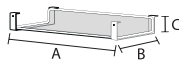

07



08



10

01 mech.1200 meccanismo ribaltabile per tavolo per piani L1200 mech.1200 mechanism for folding table for top L1200

code	finishing	q.kit	q.pack	a	b	kg.x1	vol.x1
110311-007	● zincato/zinc	x1	1	730	1165	7,00	mc. 0.0430

02 mech.1500 meccanismo ribaltabile per tavolo per piani L1500 mech.1500 mechanism for folding table for top L1500

code	finishing	q.kit	q.pack	a	b	kg.x1	vol.x1
110311-008	● zincato/zinc	x1	1	730	1465	7,81	mc. 0.0540

03 mech.1800 meccanismo ribaltabile per tavolo per piani L1800 mech.1800 mechanism for folding table for top L1800

code	finishing	q.kit	q.pack	a	b	kg.x1	vol.x1
110311-009	● zincato/zinc	x1	1	730	1765	8,62	mc. 0.0649

04 pro-gamba per tavolo con accessori pro-leg for table with accessories

code	finishing	leg width	q.kit	q.pack	a	b	kg.x1	vol.x1
110303-199	● nero rag./black	L750 mm	x2	2	730	750	3,75	mc. 0.0328
110305-199	○ bianco/white	L750 mm	x2	2	730	750	3,75	mc. 0.0328
110304-199	● grigio/grey	L750 mm	x2	2	730	750	3,75	mc. 0.0328
110303-197	● nero rag./black	L600 mm	x2	2	730	600	3,55	mc. 0.0328
110305-197	○ bianco/white	L600 mm	x2	2	730	600	3,55	mc. 0.0328
110304-197	● grigio/grey	L600 mm	x2	2	730	600	3,55	mc. 0.0328

05 top piano nobilitato rovere top wooden oak

code	finishing	q.kit	q.pack	a	b	c	kg.x1	vol.x1
120307-007	● nobilitato rovere / wooden oak	x1	1	1200	800	18	12,50	mc. 0.0173
120307-008	● nobilitato rovere / wooden oak	x1	1	1500	900	18	17,50	mc. 0.0243
120307-009	● nobilitato rovere / wooden oak	x1	1	1800	900	18	21,00	mc. 0.0291

06 modesty panel con accessori modesty panel with accessories

code	finishing	q.kit	q.pack	a	b	c	kg.x1	vol.x1
120307-010	● nobilitato rovere / wooden oak	x1	1	800	300	18	3,20	mc. 0.0043
120307-011	● nobilitato rovere / wooden oak	x1	1	1100	300	18	4,30	mc. 0.0059
120307-012	● nobilitato rovere / wooden oak	x1	1	1400	300	18	5,40	mc. 0.0075

07 portalibri bookshelf

code	finishing	q.kit	q.pack	a	b	c	kg.x1	vol.x1
113403-403	● nero rag./black	x1	1	800	363	95	3,20	mc. 0.0244
113405-403	○ bianco/white	x1	1	800	363	95	3,20	mc. 0.0244
113404-403	● grigio/grey	x1	1	800	363	95	3,20	mc. 0.0244

08 spot-coppia agganci per unione piani tavoli in plastica + viti spot-pair of plastic hooks to link the top tables + screws

code	finishing	q.kit	q.pack	kg.x1
134003-136	● nero rag./black	x2	10	0,0005

10 coppia cerniere per modesty panel + viti pair of hinges for modesty panel + screws

code	finishing	q.kit
120307-017	● zincato/zinc	x1

tipper

components/leg model option

main component sizes

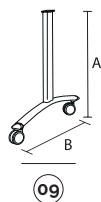

09 classic-gamba per tavolo con accessori
classic-leg for table with accessories

code	finishing	leg width	q.kit	q.pack	a	b	kg.x1	vol.x1
110303-198	● nero rag./black	L750 mm	x2	2	730	750	3,9	mc. 0.0328
110305-198	○ bianco/white	L750 mm	x2	2	730	750	3,9	mc. 0.0328
110304-198	● grigio/grey	L750 mm	x2	2	730	750	3,9	mc. 0.0328
110310-198	● cromato/chrome	L750 mm	x2	2	730	750	3,9	mc. 0.0328
110303-196	● nero rag./black	L600 mm	x2	2	730	600	3,7	mc. 0.0328
110305-196	○ bianco/white	L600 mm	x2	2	730	600	3,7	mc. 0.0328
110304-196	● grigio/grey	L600 mm	x2	2	730	600	3,7	mc. 0.0328
110310-196	● cromato/chrome	L600 mm	x2	2	730	600	3,7	mc. 0.0328

packaging

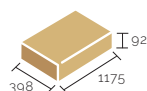

01

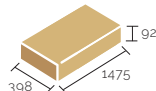

02

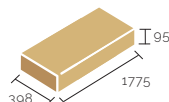

03

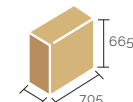

04

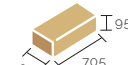

07



09





BEYOND **Design**

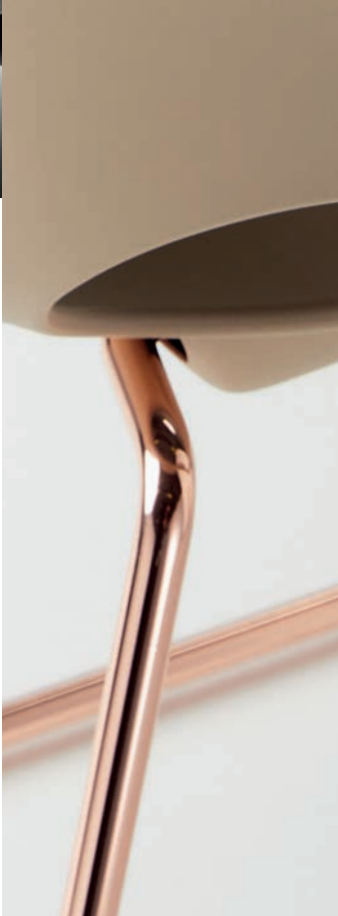



wing



wing



slide

4-legs
wooden 4-legs

swivel

bench

wing showing

tools



configurator



brochure



video

features



designed by:
shannon sadler



outdoor
ready



Wing, 3 grandi vantaggi in una seduta.

Design distintivo e massimo comfort grazie soprattutto alle due caratteristiche ali.

Estremamente funzionale e versatile prevede 5 varianti colore della monoscocca e diversi telai e accessori opzionabili.

Plus:

- grande impatto estetico, grazie al suo design distintivo;
- estremo comfort, grazie alla generosa monoscocca;
- facile da pulire e da spostare.

Wing è la nuova proposta di seduta per l'ambiente Contract e l'ambiente Home.

Wing: 3 great advantages in one chair.

Distinctive design and maximum comfort thanks in particular to the two characteristic wings. Extremely functional and versatile, available in 5 colour variants for the monocoque and various options for frames and accessories.

Advantages:

- great aesthetic impact, thanks to its distinctive design;
- outstanding comfort, thanks to the generous monocoque;
- easy to clean and move.

Wing is the new chair designed for Contract and Home environments.

wing

slide



plastic colours

- avorio/ivory ral1010
- corallo/coral 1797u
- nocciola/hazelnut 2312u
- nero/black ral9005
- blu/blue 541u

01 02 03 04 05 07 08
optional

main component sizes

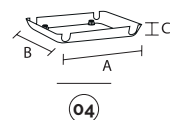
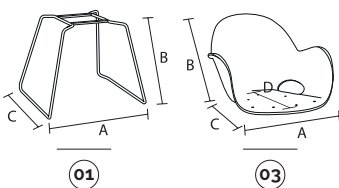

optional

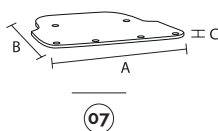

01 telaio a slitta in tondino d.12 slide wire frame d.12

code	finishing	q.kit	q.pack	a	b	c	kg.x1	vol.x1
113407-400	● ramato/copper	x1	100	540	525	440	3,54	mc. 0,026
113410-400	● cromato/chrome						3,54	mc. 0,026

02 confezione di basi a pinza antirotazione per tondino colore neutro neutral clips base for wire d.11 package

code	finishing	q.kit	q.pack
137006-070	○ neutro/neutral	x4	200

03 scocca a pozzetto con braccioli (anti-uv) plastic shell with arms (anti-uv)

code	finishing	q.kit	q.pack	a	b	c	d	kg.x1	vol.x1
133905-042	● avorio/ivory ral1010	x1	5	570	430	590	410	2,9	mc. 0,041

04 copertina in plastica (anti-uv) plastic cover (anti-uv)

code	finishing	q.kit	a	b	c	kg.x1
132205-039	● avorio/ivory ral1010	x1	265	250	40	0,15

05 vite tsp+ m6x25 zincata bianca (vite per fissaggio scocca con copertina) x 4g sl cv pc gir screw tsp+ m6x25 white zinc (screw for fix shell with cover)

code	finishing	q.kit
117711-199	● zincata bianca/white zinc	x4

07 pannello sedile multistrato plywood seat panel

code	finishing	q.kit	q.pack	a	b	c	kg.x1	vol.x1
122207-023	● faggio/plywood	x1	20	376	370	5	0,3	mc. 0,0019

08 vite tbcl m4x10 zincata bianca (vite per fissaggio pannello sedile) screw tbcl m4x10 white zinc (screw for fix seat panel)

code	finishing	q.kit
117703-124	● zincata bianca/white zinc	x6



for all colour codes, see page 37

wing

slide

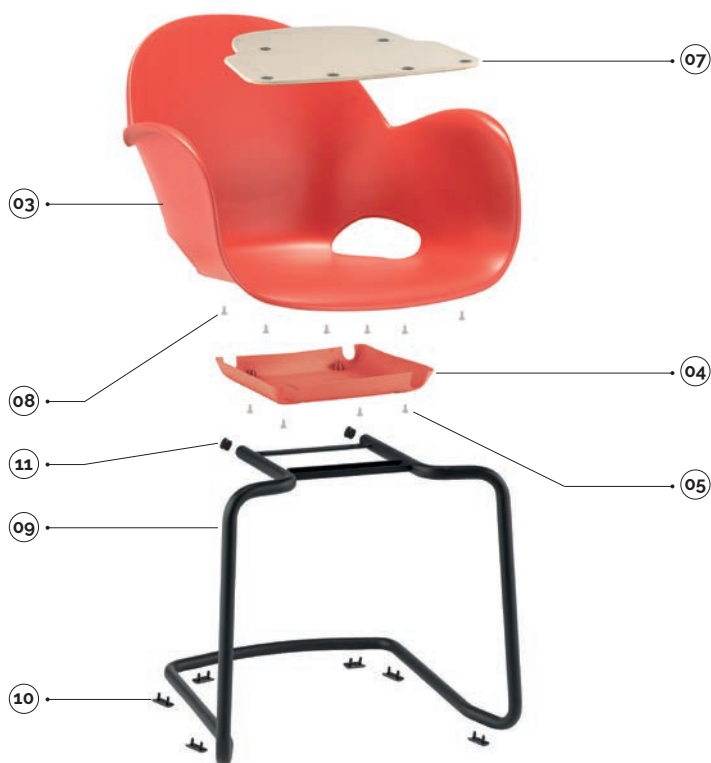

09 10 03 04 05 07 08 11
optional

plastic colours

- avorio/ivory ral1010
- corallo/coral 1797u
- nocciola/hazelnut 2312u
- nero/black ral9005
- blu/blue 541u

main component sizes

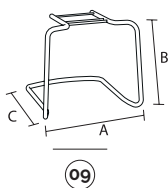

09 base a slitta in tubo d.22 senza tappi
cantilever frames d.22 without caps

code	finishing	q.kit	q.pack	a	b	c	kg.x1	vol.x1
110503-480	● nero/black	x1	64	510	450	500	3,77	mc. 0.0313
110505-480	● avorio/ivory ral1013	x1	64	510	450	500	3,77	mc. 0.0313
110504-480	● grigio/grey	x1	64	510	450	500	3,77	mc. 0.0313
110510-480	● cromato/chrome	x1	64	510	450	500	3,77	mc. 0.0313

10 pinza due pioli in polietilene nera
two pins pliers in black polythene

code	finishing	q.kit	kg.x1
134003-003	● nero/black	x6	0,05

11 tappo copritesta ø22 per cantilever
cover head cap ø22 for cantilever

code	finishing	q.kit
134103-220	● nero/black	x2
134104-220	● grigio/grey	x2

for the components below, see page 30

03 04 05 07 08



for all colour codes, see page 37

wing

4-legs



12 13 03 04 05 07 08
optional

plastic colours

- avorio/ivory ral1010
- corallo/coral 1797u
- nocciola/hazelnut 2312u
- nero/black ral9005
- blu/blue 541u

main component sizes

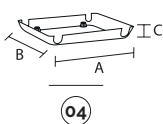
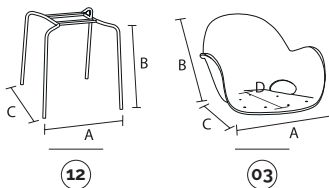

optional

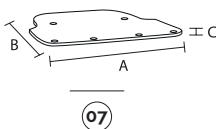

12 telaio 4 gambe d.16 senza tappi

4 legs frames d.16 without caps

code	finishing	q.kit	q.pack	a	b	c	kg.x1	vol.x1
110603-613	● nero/black	x1	200	415	445	520	2,05	mc. 0,014
110605-613	● avorio/ivory ral1013	x1	200	415	445	520	2,05	mc. 0,014
110604-613	● grigio/grey	x1	200	415	445	520	2,05	mc. 0,014
110607-613	● ramato/copper	x1	200	415	445	520	2,05	mc. 0,014
110610-613	● cromato/chrome	x1	200	415	445	520	2,05	mc. 0,014
110603-614	● nero/black 'per esterno/outdoor	x1	200	415	445	520	2,05	mc. 0,014
110605-614	● avorio/ivory ral1013 'per esterno/outdoor	x1	200	415	445	520	2,05	mc. 0,014
110604-614	● grigio/grey 'per esterno/outdoor	x1	200	415	445	520	2,05	mc. 0,014

13 puntale alettato tondo d.16 nero

inner cap for legs d.16 black

code	finishing	q.kit
134203-160	● nero/black	x4

03 scocca a pozzetto con braccioli (anti-uv)

plastic shell with arms (anti-uv)

code	finishing	q.kit	q.pack	a	b	c	d	kg.x1	vol.x1
133905-042	● avorio/ivory ral1010	x1	5	570	430	590	410	2,9	mc. 0,041

04 copertina in plastica (anti-uv)

plastic cover (anti-uv)

code	finishing	q.kit	a	b	c	kg.x1
132205-039	● avorio/ivory ral1010	x1	265	250	40	0,15

05 vite tsp+ m6x25 zincata bianca (vite per fissaggio scocca con copertina) x 4g sl cv pc gir

screw tsp+ m6x25 white zinc (screw for fix shell with cover)

code	finishing	q.kit
117711-199	● zincata bianca/white zinc	x4

07 pannello sedile multistrato

plywood seat panel

code	finishing	q.kit	q.pack	a	b	c	kg.x1	vol.x1
122207-023	● faggio/plywood	x1	20	376	370	5	0,3	mc. 0,0019

08 vite tbcl m4x10 zincata bianca (vite per fissaggio pannello sedile)

screw tbcl m4x10 white zinc (screw for fix seat panel)

code	finishing	q.kit
117703-124	● zincata bianca/white zinc	x6



for all colour codes, see page 37

wing

wooden 4-legs



plastic colours

- avorio/ivory ral1010
- corallo/coral 1797u
- nocciola/hazelnut 2312u
- nero/black ral9005
- blu/blue 541u

14 03 15 07 08
optional

main component sizes

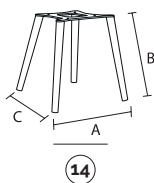

14 kit 4 gambe legno massello faggio trasparente + piastra in metallo
kit beechwood 4 legs frames with metal plate

code	finishing	plate colour	q.kit	a	b	c
120107-000	● faggio/beechwood	nero/black	x1	420	440	490
120107-001	● faggio/beechwood	bianco/white	x1	420	440	490

15 vite tbl combi m6x16 dentell, zinc. bianca (vite per fissaggio scocca senza copertina) legno
screw tbl combi m6x16 white zinc (screw for fix shell without cover) wooden 4-legs

code	finishing	q.kit
117711-191	● zincata bianca/white zinc	x4

for the components below, see page 32

03 07 08



for all colour codes, see page 37

wing

swivel



plastic colours

- avorio/ivory ral1010
- corallo/coral 1797u
- nocciola/hazelnut 2312u
- nero/black ral9005
- blu/blue 541u

main component sizes

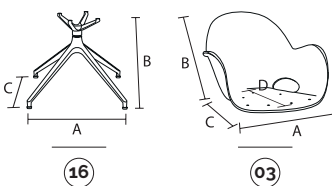

optional

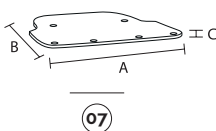

16 03 06 07 08
optional

16 base 4 razze d720 in alluminio
high aluminium base d.720

code	finishing	q.kit	q.pack	a	b	c	kg.x1
110210-090	● alluminio/aluminium	x1	6	515	415	515	4.03

03 scocca a pozzetto con braccioli (anti-uv)
plastic shell with arms (anti-uv)

code	finishing	q.kit	q.pack	a	b	c	d	kg.x1	vol.x1
133903-040	● nero/black ral9005	x1	5	570	430	590	410	2.9	mc. 0.041

06 vite t6l combi m6x12 dentell. zincata bianca (vite per fissaggio scocca senza copertina) 4g sl cv pc gir
screw t6l combi m6x12 white zinc (screw for fix shell without cover)

code	finishing	q.kit
117711-206	● zincata bianca/white zinc	x4

07 pannello sedile multistrato
plywood seat panel

code	finishing	q.kit	q.pack	a	b	c	kg.x1	vol.x1
122207-023	● faggio/plywood	x1	20	376	370	5	0.3	mc. 0.0019

08 vite t6cl m4x10 zincata bianca (vite per fissaggio pannello sedile)
screw t6cl m4x10 white zinc (screw for fix seat panel)

code	finishing	q.kit
117703-124	● zincata bianca/white zinc	x6



for all colour codes, see page 37

wing

swivel



plastic colours

- avorio/ivory ral1010
- corallo/coral 1797u
- nocciola/hazelnut 2312u
- nero/black ral9005
- blu/blue 541u

main component sizes

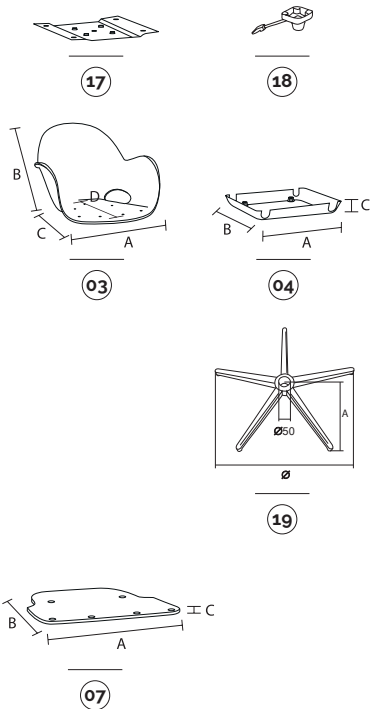

optionals

17 03 18 04 05 07 08 19
optional

17 g2p(01) gnr - piastra per girevole nera
g2p(01) gnr - plate for swivel black

code	finishing	q.kit	q.pack	kg.x1	vol.x1
110903-000	● nero/black	x1	25	0,85	mc. 0.0008

18 blocchetto in alluminio 0' d.28 x gas con leva nero opaco
black alu block 0' d.28 x gas with lever

code	finishing	q.kit	q.pack	kg.x1	vol.x1
110903-100	● nero/black	x1	1	0,305	mc. 0.0225

03 scocca a pozzetto con braccioli (anti-uv)
plastic shell with arms (anti-uv)

code	finishing	q.kit	q.pack	a	b	c	d	kg.x1	vol.x1
133915-042	● blu/blue 541u	x1	5	570	430	590	410	2,9	mc. 0.041

04 copertina in plastica (anti-uv)
plastic cover (anti-uv)

code	finishing	q.kit	a	b	c	kg.x1
132215-039	● blu/blue 541u	x1	265	250	40	0,15

05 vite tsp+ m6x25 zincata bianca (vite per fissaggio scocca con copertina) x 4g sl cv pc gir
screw tsp+ m6x25 white zinc (screw for fix shell with cover)

code	finishing	q.kit
117711-199	● zincata bianca/white zinc	x4

07 pannello sedile multistrato con 6 borchie m4
seat panel with 6 upholstery nail m4

code	finishing	q.kit	q.pack	a	b	c	kg.x1	vol.x1
122207-023	● faggio/plywood	x1	20	376	370	5	0,3	mc. 0.0019

08 vite tbcl m4x10 zincata bianca (vite per fissaggio pannello sedile)
screw tbcl m4x10 white zinc (screw for fix seat panel)

code	finishing	q.kit
117703-124	● zincata bianca/white zinc	x6

19 base in metallo d.640 con coprisaldatura
metal base d.640 with cover welding

code	finishing	q.kit	q.pack	ø	a	kg.x1	vol.x1
110210-057	● cromato/chrome	x1	5	640	112	2,25	mc. 0.0117



for all colour codes, see page 37

wing

bench

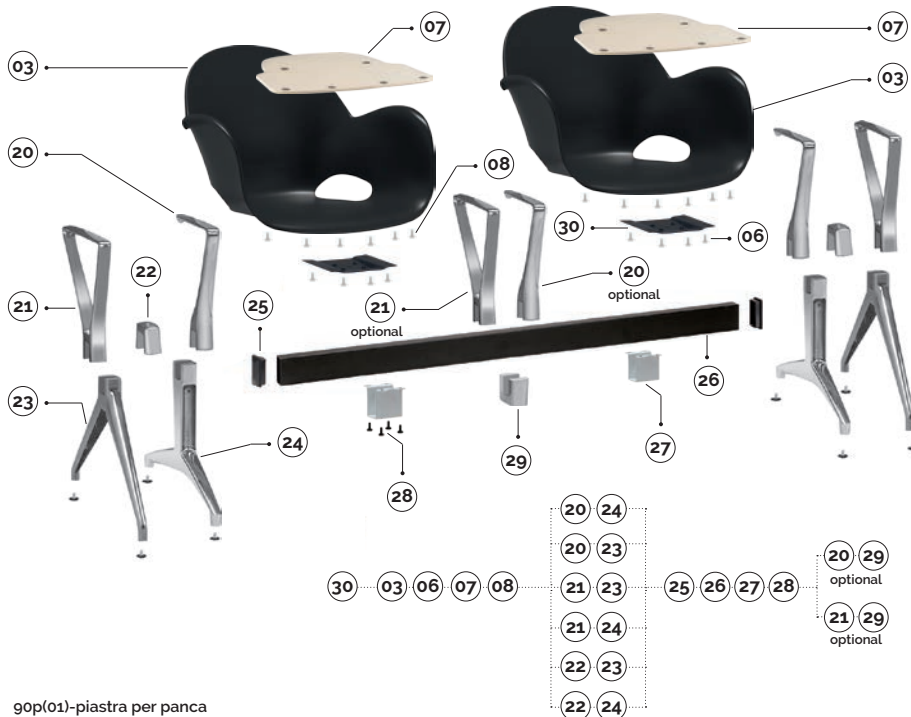

plastic colours

- avorio/ivory ral1010
- corallo/coral 1797u
- nocciola/hazelnut 2312u
- nero/black ral9005
- blu/blue 541u



30

main component sizes



20

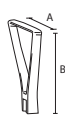

21

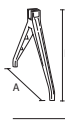

22

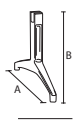

23

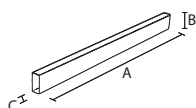

24



25



26



27



28



29

for the components below, see page 34

03 06 07 08

for the bench components, see page 249

30 90p(01)-piastra per panca
90p(01)-plate for bench

code	finishing	q.kit	q.pack	kg.x1	vol.x1
110703-013	● nero/black	x1	25	0,85	mc. 0,0008
110704-078	● grigio/grey	x1	25	0,85	mc. 0,0008

20 cut-braccioletto in alluminio per panca + n'2 viti
cut-aluminium arm for bench + n'2 screw

code	finishing	q.kit	q.pack	a	b	kg.x1	vol.x1
111704-223	● alluminio/aluminium	x1	10	300	305	1,40	mc. 0,0011

21 slim-braccioletto in alluminio per panca + n'2 viti
slim-aluminium arm for bench + n'2 screw

code	finishing	q.kit	q.pack	a	b	kg.x1	vol.x1
111704-225	● alluminio/aluminium	x1	10	325	305	1,40	mc. 0,0011

22 cut/slim-cavallotto in alluminio per gamba panca + n'2 viti
cut/slim-aluminium bracket 80x40 for bench leg + n'2 screw

code	finishing	q.kit	q.pack	kg.x1	vol.x1
111704-222	● alluminio/aluminium	x1	10	0,40	mc. 0,0012

23 slim-gamba in alluminio per panca
slim-aluminium leg for bench

code	finishing	q.kit	q.pack	a	b	kg.x1	vol.x1
111704-226	● alluminio/aluminium	x2	5	610	350	1,20	mc. 0,014

24 cut-gamba in alluminio per panca
cut-aluminium leg for bench

code	finishing	q.kit	q.pack	a	b	kg.x1	vol.x1
111704-224	● alluminio/aluminium	x2	5	610	350	2,55	mc. 0,014

25 tappo copritesta rettangolare 80x40 nero
rectangular cover head cap 80x40 black

code	finishing	q.kit
134103-001	● nero/black	x2

26 90t(03) trave per panca 80x40
90t(03) beam for bench 80x40

code	finishing		q.kit	q.pack	a	b	c	kg.x1	vol.x1
110703-190	● nero/black	2 posti / 2 seats	x1	1	1160	80	40	3,20	mc. 0,0045
110704-190	● grigio/grey	2 posti / 2 seats	x1	1	1160	80	40	3,20	mc. 0,0045
110703-191	● nero/black	3 posti / 3 seats	x1	1	1710	80	40	4,71	mc. 0,005
110704-191	● grigio/grey	3 posti / 3 seats	x1	1	1710	80	40	4,71	mc. 0,005
110703-192	● nero/black	4 posti / 4 seats	x1	1	2260	80	40	6,22	mc. 0,0085
110704-192	● grigio/grey	4 posti / 4 seats	x1	1	2260	80	40	6,22	mc. 0,0085
110703-193	● nero/black	5 posti / 5 seats	x1	1	2800	80	40	7,72	mc. 0,01
110704-197	● grigio/grey	5 posti / 5 seats	x1	1	2800	80	40	7,72	mc. 0,01

27 90cv-cavallotto sotto trave
90cv-support under beam

code	finishing	q.kit	q.pack	a	b	kg.x1	vol.x1
110703-007	● nero/black	x1	50	55	65	0,60	mc. 0,0005
110704-016	● grigio/grey	x1	50	55	65	0,60	mc. 0,0005

28 confezione viti m8x12 testa cilindrica a esagono incassato brunita nera
screws m8x12 cylindrical head hexagon embedded burnishing black package

code	finishing	q.kit	q.pack
117003-070	● nero/black	x4	200

29 cut/slim-cavallotto in alluminio per bracciolo panca
cut/slim-aluminium bracket 80x40 for bench arm

code	finishing	q.kit	q.pack	kg.x1	vol.x1
111704-221	● alluminio/aluminium	x1	10	0,32	mc. 0,0012

optionals

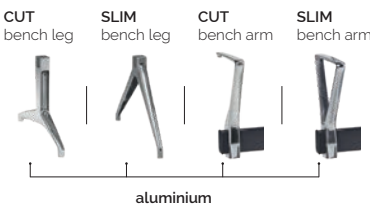
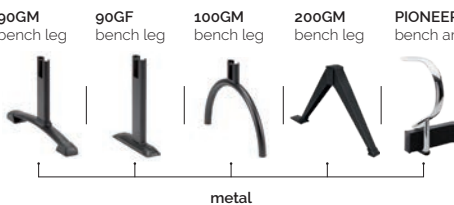

wing

optional colour codes



plastic colour codes



03 scocca a pozzetto con braccioli (anti-uv)
plastic shell with arms (anti-uv)

- 133905-042 avorio/ivory ral1010
- 133902-042 corallo/coral 1797u
- 133907-042 nocciola/hazelnut 2312u
- 133903-040 nero/black ral9005
- 133915-042 blu/blue 541u



04 copertina in plastica (anti-uv)
plastic cover (anti-uv)

- 132205-039 avorio/ivory ral1010
- 132202-039 corallo/coral 1797u
- 132207-039 nocciola/hazelnut 2312u
- 132203-039 nero/black ral9005
- 132215-039 blu/blue 541u





BEYOND **Design**





feel



feel



slide
slide w/armrests
slide w/writing tablet
stool

4 legs
4 legs w/armrest
4 legs w/writing tablet

swivel

bench



BIFMA TEST

EN 16139

tools



configurator



certification



brochure



video

feel showing

features



designed by:
stefano bettio



outdoor
ready



trolley
available



La seduta versatile e dal design distintivo.

Confortevole e dallo stile grintoso, grazie al doppio design frontale/posteriore sullo schienale. Prevede 5 telai tra cui scegliere e numerosi accessori. Disponibili inoltre i telai per braccioli e i telai per tavoletta, al fine di arredare anche ambienti dedicati alla formazione.

Plus:

- 8 colori di tendenza per la scocca;
- impilabile sia con telaio slitta sia 4 gambe;
- disponibile con pannellino in plastica da tappezzare e pratici agganci laterali;
- doppia certificazione BIFMA e CATAS

Feel è ideale per **ambienti Contract e Home**, anche in **outdoor** grazie alla specifica verniciatura dei telai.

The versatile chair with a distinctive design.

Comfortable and with rugged styling, thanks to the dual-faced design on the backrest. 5 frames to choose from and numerous accessories. Frame also available with versions featuring armrests and writing tablets, making it ideal also for training environments.

Advantages:

- 8 trendy colours for the seat shell;
- stackable in both the sled and 4-legged versions;
- available with plastic seat pad to be upholstered and practical lateral hooks;
- both BIFMA and CATAS certified

Feel is ideal for **Contract and Home environments**, even **outdoors** thanks to the special paint used on the frames.

feel

slide



CERTIFIED BY
BIFMA

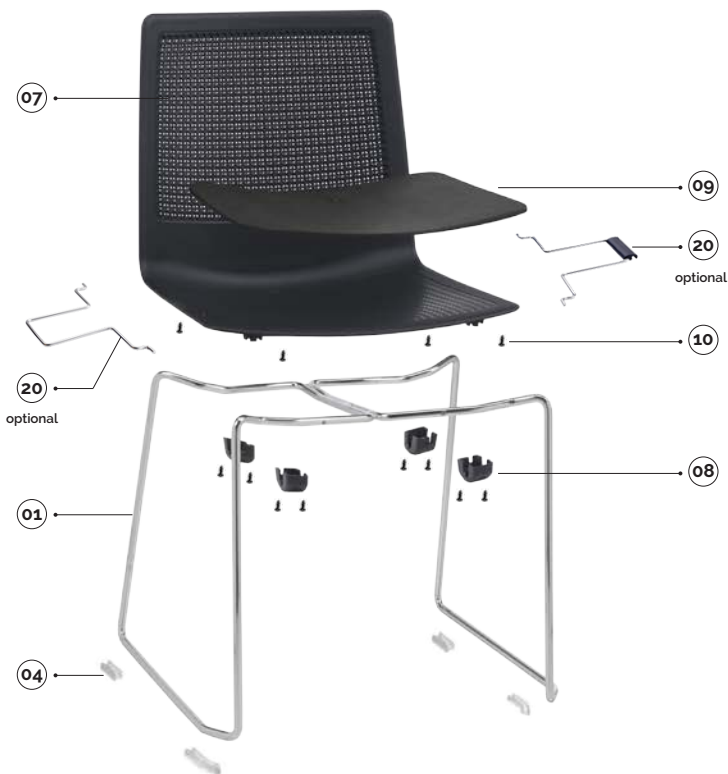

- blu/blue ral5014
- arancio/orange ral2003
- nero/black ral9005
- verde/green pantone 7495el
- bianco/white 218
- grigio/grey ral7003
- sabbia/sand ral1019
- rosso/red ral527
- bianco autoestinguente/
fire retardant white 218

plastic colours

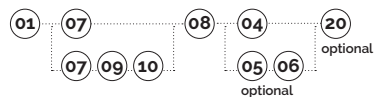

main component sizes

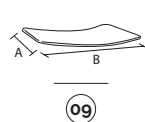
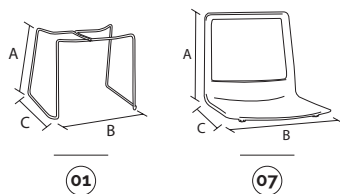

optipnals

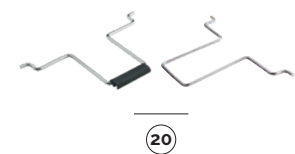
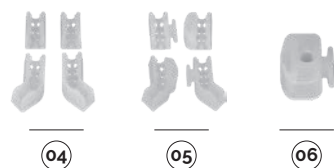

01 feel-telaio a slitta in tondino d.12 feel-slide wire frame d.12

code	finishing	q.kit	q.pack	a	b	c	kg.x1	vol.x1
113410-057	● cromato/chrome	x1	100	460	530	470	3,75	mc. 0.03

04 btf-kit piedini btf-kit feet

code	finishing	q.kit	q.pack	kg.x1
134306-001	○ neutro/neutral	x1	100	0,05

05 btfa-kit piedini con ganci btfa-kit feet with hooks

code	finishing	q.kit	q.pack	kg.x1
134306-002	○ neutro/neutral	x1	100	0,06

06 pptf-tappo per fissaggio pavimento pptf-cap for fixing to the floor

code	finishing	q.kit	q.pack	kg.x1
134306-003	○ neutro/neutral	x2	100	0,03

07 feel-scocca intera modello feel feel-plastic shell model feel

code	finishing	q.kit	q.pack	a	b	c	kg.x1	vol.x1
133903-060	● nero/black ral9005	x1	10	420	450	430	1,70	mc. 0.02

08 feel-confezione accessori per scocca feel per tondino feel-accessory pack for wire frame feel

code	finishing	q.kit	q.pack	kg.x1	vol.x1
137003-061	● nero/black ral9005	x1	10	wire frame	0,07 mc. 0.001

09 feel-pannello sedile da tappezzare feel-panel back for upholstery

code	finishing	q.kit	q.pack	a	b	kg.x1	vol.x1
132203-059	● nero/black	x1	25	400	440	0,6	mc. 0.003

10 vite hilo tb+ 5x14 zincata nera (per fissare pannello sedile) screw hilo tb+ 5x14 for upholstery seat panel

code	finishing	q.kit
117803-155	● nero/black	x8

20 feel-coppia agganci laterale in tondino + plastica feel-pair side wire hooks + plastic

code	finishing	q.kit	kg.x1	vol.x1
113410-056	● cromato/chrome	x1	0,15	mc. 0.002



feel

slide w/armrests

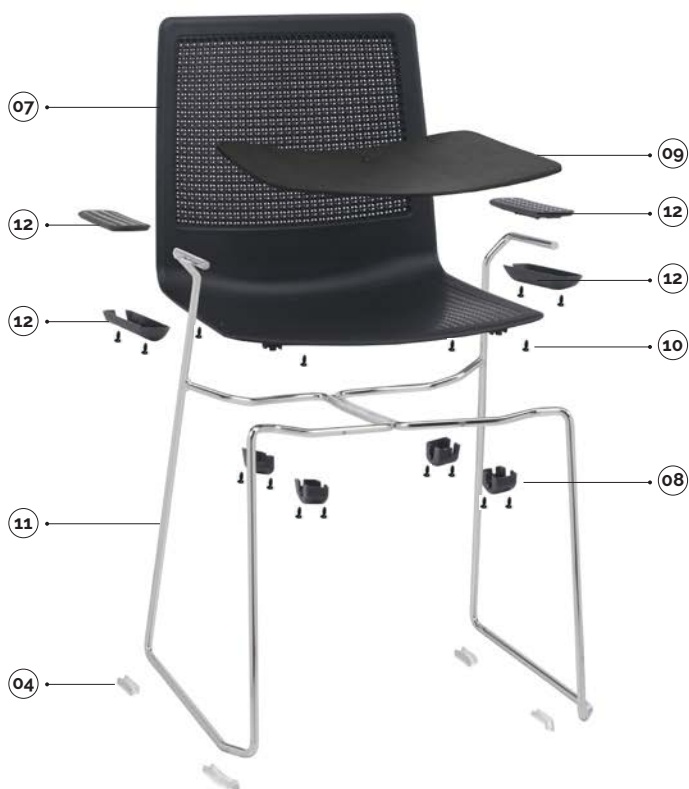

- blu/blue ral5014
- arancio/orange ral2003
- nero/black ral9005
- verde/green pantone 7495el
- bianco/white 218
- grigio/grey ral7003
- sabbia/sand ral1019
- rosso/red ral527
- bianco autoestinguente/
fire retardant white 218

plastic colours

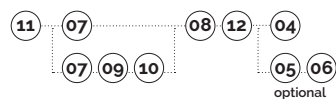

11 feel-telaio a slitta in tondino d.12 con braccioli
feel-slide wire frame d.12 with arms

code	finishing	q.kit	q.pack	a	b	c	kg.x1	vol.x1
113410-058	● cromato/chrome	x1	60	460	530	470	4,50	mc. 0.035

12 feel-coppia braccioli in plastica colorata + viti
feel-pair colored plastic arm + screws

code	finishing	q.kit	q.pack	a	b	kg.x1	vol.x1
131703-062	● nero/black ral9005	x1	20	right + left	200 30	0,16	mc. 0.001

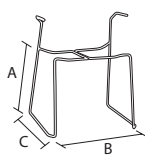

11



12

main component sizes

for the components below, see page 42

- 04 05 06 07 08 09 10



for all colour codes, see page 51



feel-carrello portasedie con accessori nero
feel-trolley for chairs with accessories black

code	finishing	q.kit
110803-329	● nero/black	x1

feel

slide w/writing tablet

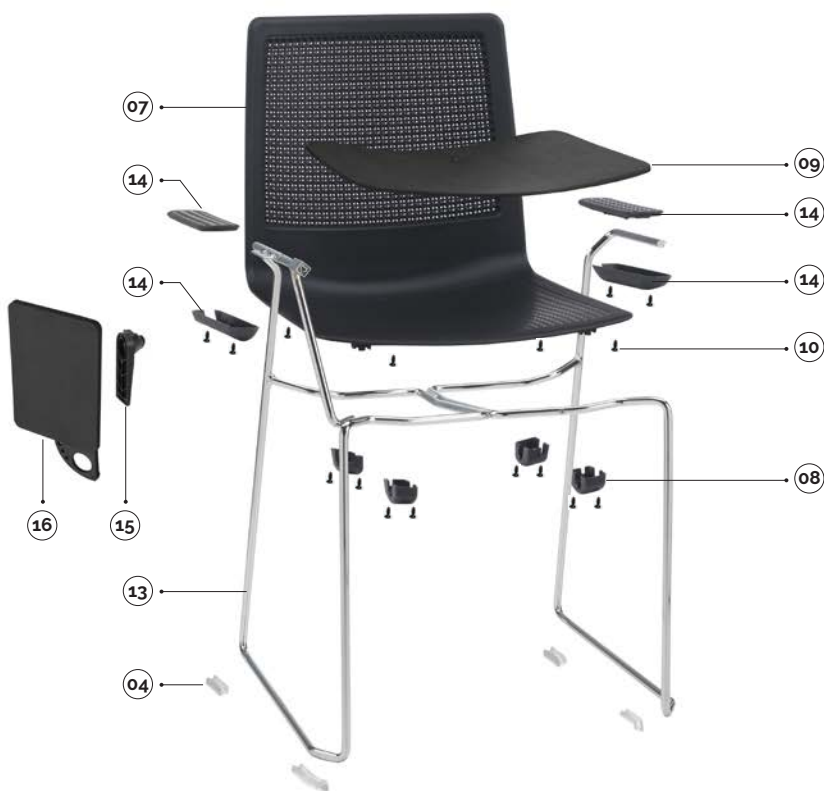

- plastic colours
- blu/blue ral5014
 - arancio/orange ral2003
 - nero/black ral9005
 - verde/green pantone 7495el
 - bianco/white 218
 - grigio/grey ral7003
 - sabbia/sand ral1019
 - rosso/red ral527
 - bianco autoestinguente/ fire retardant white 218

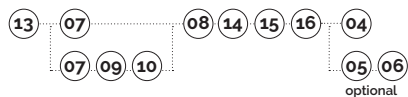

plastic colours

main component sizes

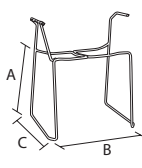

13



14



15

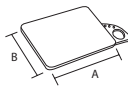

16

13 feel-telaio a slitta in tondino d.12 con braccioli e portatavoletta
feel-slide wire frame d.12 with arms and writing tablet hook

code	finishing	q.kit	q.pack	a	b	c	kg.x1	vol.x1
113410-072	● cromato/chrome right writing tablet hook	x1	30	460	530	470	5,00	mc. 0,07
113410-073	● cromato/chrome left writing tablet hook	x1	30	460	530	470	5,00	mc. 0,07

14 feel-coppia braccioli in plastica colorata per tavoletta + viti
feel-pair colored plastic arm for tablet + screws

code	finishing	q.kit	q.pack	a	b	kg.x1	vol.x1
131703-063	● nero/black ral9005	x1	20	right-left for tablet	200	30	0,16 mc. 0,0045
131703-064	● nero/black ral9005	x1	20	left-right for tablet	200	30	0,16 mc. 0,0045

15 spt2-snodo per tavoletta in termoplastica
spt2-thermoplastic writing tablet articulation

code	finishing	q.kit	q.pack	a	b	c	kg.x1	vol.x1
134003-039	● nero/black	x1	20	180	66	15x15	0,35	mc. 0,0006

16 tlt3-tavoletta ambidestro con portabicchiere e portapenne
tlt3-writing tablet with cup holder and pen tray

code	finishing	q.kit	q.pack	a	b	kg.x1	vol.x1
134003-041	● nero/black	x1	10	410	300	1,05	mc. 0,036

for the components below, see page 42

04 05 06 07 08 09 10



for all colour codes, see page 51

TLT
tablet



TLT2
tablet



TLT3
tablet



BEAN
tablet



TL02
tablet



SPT2
mechanism tablet



SPTA
mechanism antipanic



for writing tablet options, see page 242/243

feel

stool

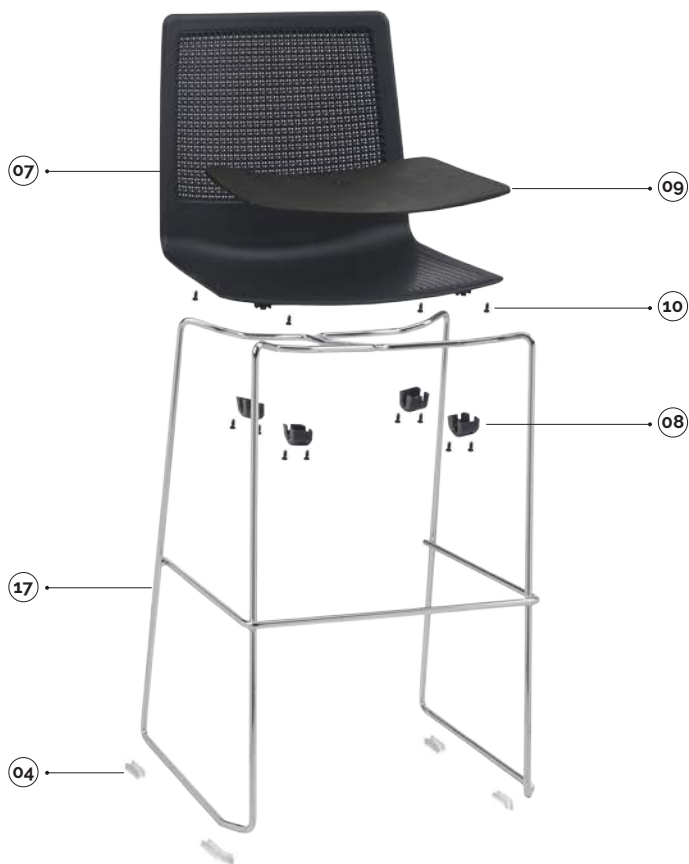

plastic colours

- blu/blue ral5014
- arancio/orange ral2003
- nero/black ral9005
- verde/green pantone 7495el
- bianco/white 218
- grigio/grey ral7003
- sabbia/sand ral1019
- rosso/red ral527
- bianco autoestinguente/ fire retardant white 218

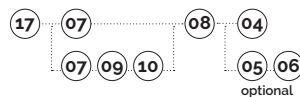

main component sizes

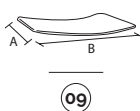
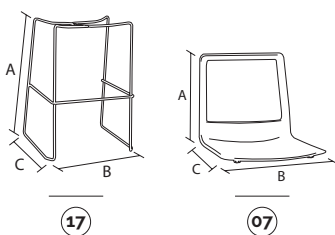

optional

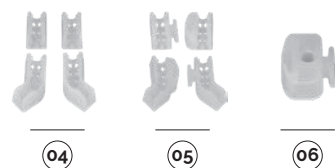

17 feel-sgabello alto h730 in tondino d.12 per scocca senza tappi feel-wire d.12 high bar stool.H730 for shell feel without caps

code	finishing	q.kit	q.pack	a	b	c	kg.x1	vol.x1
113410-059	● cromato/chrome	x1	50	730	530	500	6,20	mc. 0,08

04 btf-kit piedini btf-kit feet

code	finishing	q.kit	q.pack	kg.x1
134306-001	○ neutro/neutral	x1	100	0,05

05 btfa-kit piedini con ganci btfa-kit feet with hooks

code	finishing	q.kit	q.pack	kg.x1
134306-002	○ neutro/neutral	x1	100	0,06

06 pptf-tappo per fissaggio pavimento pptf-cap for fixing to the floor

code	finishing	q.kit	q.pack	kg.x1
134306-003	○ neutro/neutral	x2	100	0,03

07 feel-scocca intera modello feel feel-plastic shell model feel

code	finishing	q.kit	q.pack	a	b	c	kg.x1	vol.x1
133903-060	● nero/black ral9005	x1	10	420	450	430	1,70	mc. 0,02

08 feel-confezione accessori per scocca feel per tondino feel-accessory pack for wire frame feel

code	finishing	q.kit	q.pack	kg.x1	vol.x1
137003-061	● nero/black ral9005	x1	10	telaio in tondino/wire	0,07 mc. 0,001

09 feel-pannello sedile da tappezzare feel-panel back for upholstery

code	finishing	q.kit	q.pack	a	b	kg.x1	vol.x1
132203-059	● nero/black	x1	25	400	440	0,6	mc. 0,003

10 vite hilo tb+ 5x14 zincata nera (per fissare pannello sedile) screw hilo tb+ 5x14 for upholstery seat panel

code	finishing	q.kit
117803-155	● nero/black	x8



for all colour codes, see page 51

feel

4-legs



CERTIFIED BY
CATAS



- blu/blue ral5014
- arancio/orange ral2003
- nero/black ral9005
- verde/green pantone 7495el
- bianco/white 218
- grigio/grey ral7003
- sabbia/sand ral1019
- rosso/red ral527
- bianco autoestinguente/
fire retardant white 218

plastic colours

main component sizes

optipnats

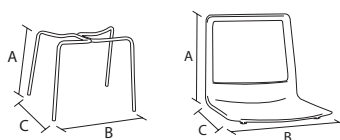

18

07



09

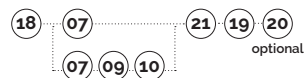

18 feel-telaio 4 gambe in tubo d.18 senza tappi
feel-4 legs frames d.18 without caps

code	finishing	q.kit	q.pack	a	b	c	kg.x1	vol.x1
112703-031	● nero/black ral9005	x1	200	440	510	500	2	mc. 0.025
112704-031	● grigio/grey ral7003	x1	200	440	510	500	2	mc. 0.025
112705-031	○ bianco/white ral9003	x1	200	440	510	500	2	mc. 0.025
112710-031	● cromato/chrome	x1	200	440	510	500	2	mc. 0.025
112703-032'	● nero/black ral9005 'per esterno/outdoor	x1	200	440	510	500	2	mc. 0.025
112704-032'	● grigio/grey ral7003 'per esterno/outdoor	x1	200	440	510	500	2	mc. 0.025
112705-032'	○ bianco/white ral9003 'per esterno/outdoor	x1	200	440	510	500	2	mc. 0.025

19 confezione puntali tondi d.18 neri
black inner round caps d.18 package

code	finishing	q.kit	q.pack
137003-072	● nero/black	x1	200
134205-181	○ bianco/white	x1	

07 feel-scocca intera modello feel
feel-plastic shell model feel

code	finishing	q.kit	q.pack	a	b	c	kg.x1	vol.x1
133903-060	● nero/black ral9005	x1	10	420	450	430	1,70	mc. 0.02

21 feel-confezione accessori per scocca feel per tubo d.18
feel-accessory pack for shell feel for tube d.18

code	finishing	q.kit	q.pack	kg.x1	vol.x1
137003-060	● nero/black ral9005	x1	10	telaio tubo/tube frame	0,07 mc. 0.001

09 feel-pannello sedile da tappezzare
feel-panel back for upholstery

code	finishing	q.kit	q.pack	a	b	kg.x1	vol.x1
132203-059	● nero/black	x1	25	400	440	0,6	mc. 0.003

10 vite hilo tb+ 5x14 zincata nera (per fissare pannello sedile)
screw hilo tb+ 5x14 for upholstery seat panel

code	finishing	q.kit
117803-155	● nero/black	x8

20 feel-coppia agganci laterale in tondino + plastica
feel-pair side wire hooks + plastic

code	finishing	q.kit	kg.x1	vol.x1
113410-056	● cromato/chrome	x1	0,15	mc. 0.002



for all colour codes, see page 51

feel

4-legs w/armrests



- blu/blue ral5014
- arancio/orange ral2003
- nero/black ral9005
- verde/green pantone 7495el
- bianco/white 218
- grigio/grey ral7003
- sabbia/sand ral1019
- rosso/red ral527
- bianco autoestinguente/ fire retardant white 218

plastic colours

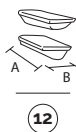
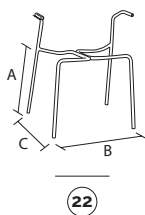
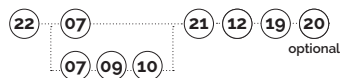

main component sizes

22 feel-telaio 4 gambe d.18 con braccioli senza tappi feel-4 legs frame d.18 with arm and without caps

code	finishing		q.kit	q.pack	a	b	c	kg.x1	vol.x1
112703-033	● nero/black ral9005		x1	60	440	510	500	2,6	mc. 0.035
112704-033	● grigio/grey ral7003		x1	60	440	510	500	2,6	mc. 0.035
112705-033	○ bianco/white ral9003		x1	60	440	510	500	2,6	mc. 0.035
112710-033	● cromato/chrome		x1	60	440	510	500	2,6	mc. 0.035
112703-034'	● nero/black ral9005	*per esterno/outdoor	x1	60	440	510	500	2,6	mc. 0.035
112704-034'	● grigio/grey ral7003	*per esterno/outdoor	x1	60	440	510	500	2,6	mc. 0.035
112705-034'	○ bianco/white ral9003	*per esterno/outdoor	x1	60	440	510	500	2,6	mc. 0.035

12 feel-coppia braccioli in plastica colorata + viti feel-pair colored plastic arm + screws

code	finishing		q.kit	q.pack	a	b	kg.x1	vol.x1
131703-062	● nero/black ral9005		x1	20	right + left	200 30	0,16	mc. 0.001

for the components below, see page 46

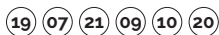

for all colour codes, see page 51

optional

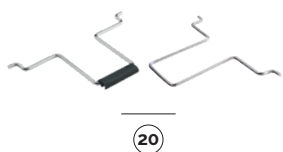

feel

4-legs w/writing tablet



- blu/blue ral5014
- arancio/orange ral2003
- nero/black ral9005
- verde/green pantone 7495el
- bianco/white 218
- grigio/grey ral7003
- sabbia/sand ral1019
- rosso/red ral527
- bianco autoestinguente/ fire retardant white 218

plastic colours

main component sizes

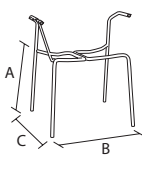

23



14



15

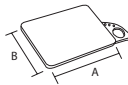

16

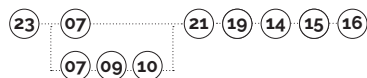

23 feel-telaio 4 gambe in tubo d.18 senza tappi con braccioli e portatavoletta
feel-4 legs frames d.18 without caps with armrests and writing tablet hook

code	finishing		q.kit	q.pack	a	b	c	kg.x1	vol.x1
112703-037	● nero/black	ral9005 - right writ. tab. hook	x1	30	440	510	500	3,50	mc. 0.07
112704-037	● grigio/grey	ral7003 - right writ. tab. hook	x1	30	440	510	500	3,50	mc. 0.07
112705-037	○ bianco/white	ral9003 - right writ. tab. hook	x1	30	440	510	500	3,50	mc. 0.07
112710-037	● cromato/chrome	right writing tablet hook	x1	30	440	510	500	3,50	mc. 0.07
112703-038	● nero/black	ral9005 - left writ. tab. hook	x1	30	440	510	500	3,50	mc. 0.07
112704-038	● grigio/grey	ral7003 - left writ. tab. hook	x1	30	440	510	500	3,50	mc. 0.07
112705-038	○ bianco/white	ral9003 - left writ. tab. hook	x1	30	440	510	500	3,50	mc. 0.07
112710-038	● cromato/chrome	left writing tablet hook	x1	30	440	510	500	3,50	mc. 0.07

14 feel-coppia braccioli in plastica colorata per tavoletta + viti
feel-pair colored plastic arm for tablet + screws

code	finishing		q.kit	q.pack	a	b	kg.x1	vol.x1
131703-063	● nero/black	ral9005	x1	20	right+left for tablet	200 30	0,16	mc. 0.0045
131703-064	● nero/black	ral9005	x1	20	left+right for tablet	200 30	0,16	mc. 0.0045

15 sp2z-snodo per tavoletta in termoplastica
sp2z-thermoplastic writing tablet articulation

code	finishing		q.kit	q.pack	a	b	c	kg.x1	vol.x1
134003-039	● nero/black		x1	20	180	66	15x15	0,35	mc. 0.0006

16 tl3-tavoletta ambidestro con portabicchiere e portapenne
tl3-writing tablet with cup holder and pen tray

code	finishing		q.kit	q.pack	a	b	kg.x1	vol.x1	
134003-041	● nero/black		x1	10	410	300		1,05	mc. 0.036

for the components below, see page 46



for all colour codes, see page 51



TLT
tablet

TLT2
tablet

TLT3
tablet

BEAN
tablet

TL02
tablet

SPT2
mechanism tablet

SPTA
mechanism antipanic



for writing tablet options, see page 242/243

feel

swivel



plastic colours

- blu/blue ral5014
- arancio/orange ral2003
- nero/black ral9005
- verde/green pantone 7495el
- bianco/white 218
- grigio/grey ral7003
- sabbia/sand ral1019
- rosso/red ral527
- bianco autoestinguente/ fire retardant white 218

main component sizes

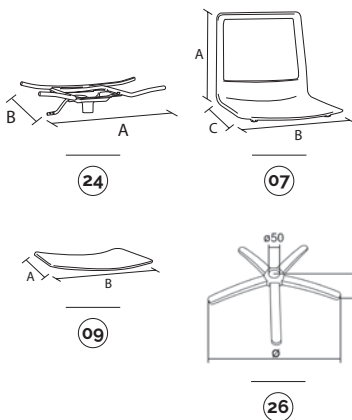

optional

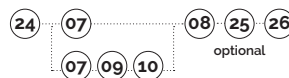
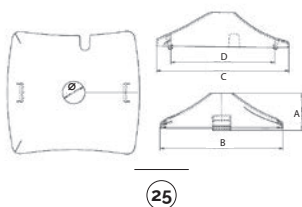

24 feel-supporto girevole a gas per scocca feel feel-swivel frame for feel shell

code	finishing	q.kit	q.pack	a	b	kg.x1	vol.x1
110903-033	● nero/black ral9005	x1	10	400	320	2,20	mc. 0,004
110904-033	● grigio/grey ral7003	x1	10	400	320	2,20	mc. 0,004

07 feel-scocca intera modello feel feel-plastic shell model feel

code	finishing	q.kit	q.pack	a	b	c	kg.x1	vol.x1
133903-060	● nero/black ral9005	x1	10	420	450	430	1,70	mc. 0,02

08 feel-confezione accessori per scocca feel per tondino feel-accessory pack for wire frame feel

code	finishing	q.kit	q.pack	kg.x1	vol.x1
137003-061	● nero/black ral9005	x1	10	wire frame	0,07 mc. 0,001

09 feel-pannello sedile da tappezzare feel-panel base for upholstery

code	finishing	q.kit	q.pack	a	b	kg.x1	vol.x1
132203-059	● nero/black	x1	25	400	440	0,6	mc. 0,003

10 vite hilo tb+ 5x14 zincata nera (per fissare pannello sedile) screw hilo tb+ 5x14 for upholstery seat panel

code	finishing	q.kit
117803-155	● nero/black	x8

25 cpg-copertina in plastica per telaio girevole cpg-plastic cover for swivel frame

code	finishing	q.kit	q.pack	a	b	c	d	ø	kg.x1	vol.x1
130903-000	● nero/black	x1	50	60	200	210	167	36	0,1	mc. 0,0015

26 b40-base in metallo d.640 con coprisaldatura b40-metal base d.640 with cover welding

code	finishing	q.kit	q.pack	a	ø	kg.x1	vol.x1
110210-027	● cromato/chrome	x1	5	60	640	2,85	mc. 0,014

CPG
plastic cover for swivel frame



for all colour codes, see page 51

feel

bench



- blu/blue ral5014
- arancio/orange ral2003
- nero/black ral9005
- verde/green pantone 7495el
- bianco/white 218
- grigio/grey ral7003
- sabbia/sand ral1019
- rosso/red ral527
- bianco autoestinguente/ fire retardant white 218

plastic colours



main component sizes

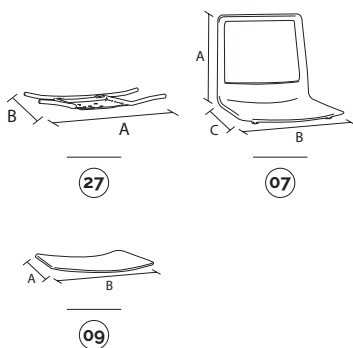

27 feel-supporto per attacco scocca feel su panca feel-bench frame for feel shell

code	finishing	q.kit	q.pack	a	b	kg.x1	vol.x1
110703-029	● nero/black	x1	10	400	320	2,10	mc. 0,004

07 feel-scocca intera modello feel feel-plastic shell model feel

code	finishing	q.kit	q.pack	a	b	c	kg.x1	vol.x1
133903-060	● nero/black ral9005	x1	10	420	450	430	1,70	mc. 0,02

08 feel-confezione accessori per scocca feel per tondino feel-accessory pack for wire frame feel

code	finishing	q.kit	q.pack	kg.x1	vol.x1
137003-061	● nero/black ral9005	x1	10	wire frame	mc. 0,001

09 feel-pannello sedile da tappezzare feel-panel back for upholstery

code	finishing	q.kit	q.pack	a	b	kg.x1	vol.x1
132203-059	● nero/black	x1	25	400	440	0,6	mc. 0,003

10 vite hilo tb+ 5x14 zincata nera (per fissare pannello sedile) screw hilo tb+ 5x14 for upholstery seat panel

code	finishing	q.kit
117803-155	● nero/black	x8

for the bench components, see page 249



for all colour codes, see page 51

OPTIONAL
bench
connector

E-USB **NEW**
bench plug



optionals

JIM **NEW**
bench leg

APOLL
bench arm



plastic

90GM
bench leg

90GF
bench leg

100GM
bench leg

200GM
bench leg

PIONEER
bench arm



metal

CUT
bench leg

SLIM
bench leg

CUT
bench arm

SLIM
bench arm



aluminium

feel

optional colour codes

shell colour codes



07 scocche in plastica plastic shells

●	133915-060	blu/blue ral5014
●	133907-060	arancio/orange ral2003
●	133903-060	nero/black ral9005
●	133916-060	verde/green pantone 7495el
○	133905-060	bianco/white 218
●	133904-060	grigio/grey ral7003
●	133907-059	sabbia/sand ral1019
●	133902-060	rosso/red ral527
○	133905-059	bianco autoestinguente/ fire retardant white 218

accessory and armrest colour codes



08 accessori in plastica per telai slitta/girevole/panca plastic accessories for wire/swivel/bench frames

●	137015-061	blu/blue ral5014
●	137007-061	arancio/orange ral2003
●	137003-061	nero/black ral9005
●	137016-061	verde/green pantone 7495el
○	137005-061	bianco/white 218
●	137004-061	grigio/grey ral7003
●	137007-058	sabbia/sand ral1019
●	137002-061	rosso/red ral527
○	137005-063	bianco autoestinguente/ fire retardant white 218



21 accessori in plastica per telaio 4-gambe plastic accessories for 4-legs frame

●	137015-060	blu/blue ral5014
●	137007-060	arancio/orange ral2003
●	137003-060	nero/black ral9005
●	137016-060	verde/green pantone 7495el
○	137005-060	bianco/white 218
●	137004-060	grigio/grey ral7003
●	137007-059	sabbia/sand ral1019
●	137002-060	rosso/red ral527
○	137005-062	bianco autoestinguente/ fire retardant white 218



12 braccioli in plastica per telai 4-gambe e filo plastic armrests for 4-legs and wire frames

●	131715-062	blu/blue ral5014
●	131707-062	arancio/orange ral2003
●	131703-062	nero/black ral9005
●	131716-062	verde/green pantone 7495el
○	131705-062	bianco/white 218
●	131704-062	grigio/grey ral7003
●	131707-059	sabbia/sand ral1019
●	131702-062	rosso/red ral527
○	131705-162	bianco autoestinguente/ fire retardant white 218



14 braccioli in plastica per tavoletta per telai 4-gambe e filo plastic armrests for tablet for 4-legs and wire frames

●	131715-063	right + left for tablet	blu/blue ral5014
●	131715-064	left + right for tablet	blu/blue ral5014
●	131707-063	right + left for tablet	arancio/orange ral2003
●	131707-064	left + right for tablet	arancio/orange ral2003
●	131703-063	right + left for tablet	nero/black ral9005
●	131703-064	left + right for tablet	nero/black ral9005
●	131716-063	right + left for tablet	verde/green pantone 7495el
●	131716-064	left + right for tablet	verde/green pantone 7495el
○	131705-063	right + left for tablet	bianco/white 218
○	131705-064	left + right for tablet	bianco/white 218
●	131704-063	right + left for tablet	grigio/grey ral7003
●	131704-064	left + right for tablet	grigio/grey ral7003
●	131707-060	right + left for tablet	sabbia/sand ral1019
●	131707-061	left + right for tablet	sabbia/sand ral1019
●	131702-063	right + left for tablet	rosso/red ral527
●	131702-064	left + right for tablet	rosso/red ral527
○	131705-163	right + left for tablet	bianco autoest./fire retardant white 218
○	131705-164	left + right for tablet	bianco autoest./fire retardant white 218





BEYOND **Innovation**





e:usb



e:usb



components

e:usb showing



tools



video



La soluzione funzionale, innovativa e di design.

Progettata per migliorare l'attesa nelle aree Community, consente agli utenti di caricare i propri devices stando comodamente seduti.

Plus:

- si adatta a qualsiasi modello di trave per panca con sezione 80X40mm;
- può essere utilizzata per due dispositivi contemporaneamente;
- stile minimal grazie alla forma arrotondata e al colore in nero/grigio.

E:Usb è pensata per tutte le **Aree d'attesa**.

Designer solution which is functional and innovative.

E:Usb is the AlbaComponents solution that helps improve the experience of users while waiting in Community areas, allowing them to charge their devices while comfortably seated.

Advantages:

- adapts to any model of beam for bench with section 80X40mm;
- can be used to charge two devices simultaneously;
- discreet styling thanks to the rounded shape and black/grey colour.

E:Usb is designed for all **waiting areas**.

e:usb

components

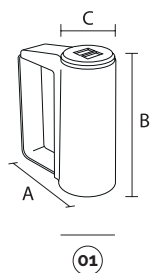

01 e:usb-caricatore per panca
e:usb-bench plug

code	finishing	q.kit	q.pack	a	b	c	kg.x1	vol.x1
130703-002	● nero/black	x1	5	85	100	38	0,28	mc. 0,0009



puoi caricare fino a due dispositivi contemporaneamente
you can charge up to two devices simultaneously



e:usb

components





BEYOND **Design**

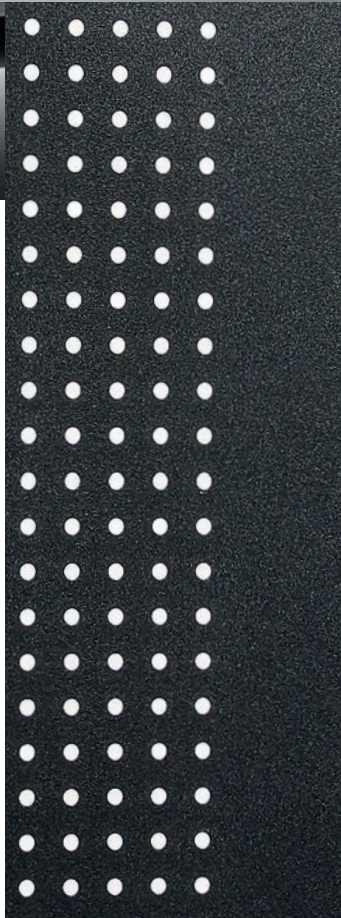



aria



aria



bench

aria

bench

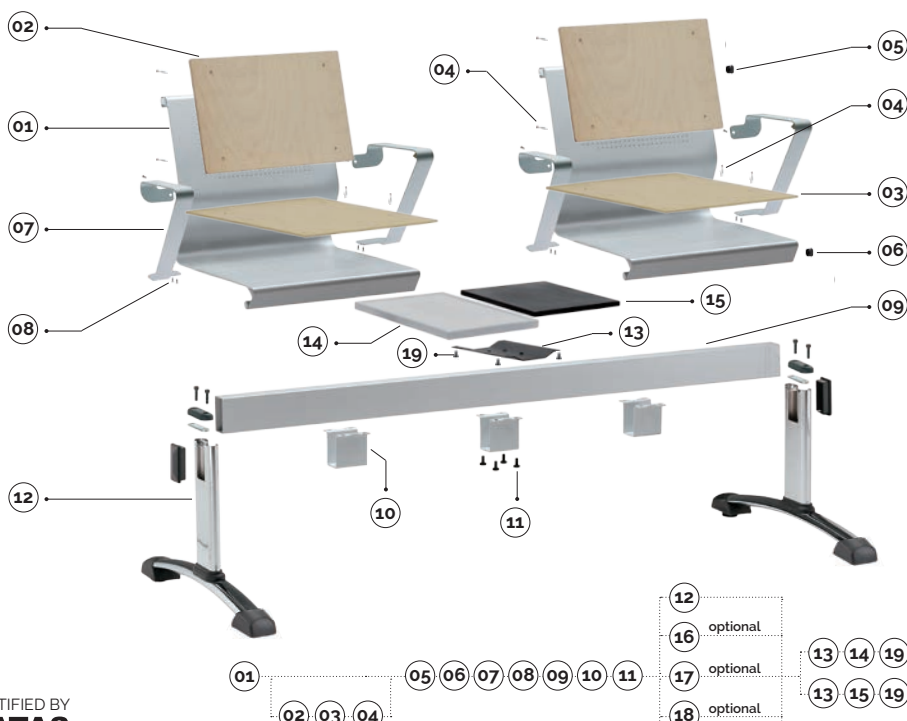

CERTIFIED BY
CATAS

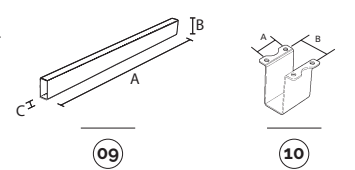
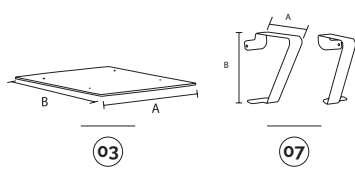
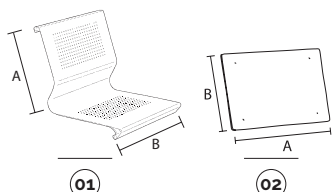

main component sizes

01 aria-scocca intera in lamiera
aria-shell metal sheet

code	finishing	q.kit	q.pack	a	b	kg.x1	vol.x1
110703-065	● nero/black	x1	25	475	490	10,50	mc. 0.02
110703-066	● nero/black fori x bracc./holes for arms	x1	25	475	490	10,50	mc. 0.02
110704-025	● grigio/grey	x1	25	475	490	10,50	mc. 0.02
110704-027	● grigio/grey fori x bracc./holes for arms	x1	25	475	490	10,50	mc. 0.02

02 aria-shl-pannello schienale in legno
aria-shl-plywood back panel for upholstery

code	finishing	q.kit	q.pack	a	b	kg.x1	vol.x1
122107-007	● faggio/plywood	x1	20	430	245	0,45	mc. 0.00225

03 aria-sdl-pannello sedile in legno
aria-sdl-plywood seat panel for upholstery

code	finishing	q.kit	q.pack	a	b	kg.x1	vol.x1
122207-007	● faggio/plywood	x1	20	430	420	0,735	mc. 0.00225

04 vite tbei m4x8 zincata bianca
screw tbei m4x8 white zinc

code	finishing	q.kit
117703-126	○ zincata bianca/white zinc	x4

05 tappo copritesta ovale 40x20 testa cromata
cover head 40x20 oval chrome

code	finishing	q.kit
134110-001	● cromato/chrome	x2

06 tappo copritesta d.20 testa cromata
cover head d.20 chrome

code	finishing	q.kit
134110-200	● cromato/chrome	x2

07 aria-bracciolo in metallo per scocca
aria-metal arm for shell

code	finishing	q.kit	q.pack	a	b	kg.x1	vol.x1
111703-001	● nero/black destro/right	x1	5	300	270	1,68	mc. 0.02
111703-002	● nero/black sinistro/left	x1	5	300	270	1,68	mc. 0.02
111704-001	● grigio/grey destro/right	x1	5	300	270	1,68	mc. 0.02
111704-002	● grigio/grey sinistro/left	x1	5	300	270	1,68	mc. 0.02

08 vite testa bombata esagono incassato m6x14 zincata
screw m6x14 head hexagon embedded zinc

code	finishing	q.kit
117711-185	● zincata/zinc	x3

09 got(03) trave per panca 80x40
got(03) beam for bench 80x40

code	finishing	q.kit	q.pack	a	b	c	kg.x1	vol.x1
110703-190	● nero/black 2 posti / 2 seats	x1	1	1160	80	40	3,20	mc. 0.0045
110704-090	● grigio/grey 2 posti / 2 seats	x1	1	1160	80	40	3,20	mc. 0.0045
110703-191	● nero/black 3 posti / 3 seats	x1	1	1710	80	40	4,71	mc. 0.005
110704-091	● grigio/grey 3 posti / 3 seats	x1	1	1710	80	40	4,71	mc. 0.005
110703-192	● nero/black 4 posti / 4 seats	x1	1	2260	80	40	6,22	mc. 0.0085
110704-092	● grigio/grey 4 posti / 4 seats	x1	1	2260	80	40	6,22	mc. 0.0085
110703-193	● nero/black 5 posti / 5 seats	x1	1	2800	80	40	7,72	mc. 0.01
110704-193	● grigio/grey 5 posti / 5 seats	x1	1	2800	80	40	7,72	mc. 0.01

10 gocv-cavalotto sotto trave
gocv-support under beam

code	finishing	q.kit	q.pack	a	b	kg.x1	vol.x1
110703-007	● nero/black	x1	50	55	65	0,60	mc. 0.0005
110704-016	● grigio/grey	x1	50	55	65	0,60	mc. 0.0005

11 confezione viti m8x12 testa cilindrica a esagono incassato brunita nera
screws m8x12 cylindrical head hexagon embedded burnishing black package

code	finishing	q.kit	q.pack
117003-070	● nero/black	x4	200

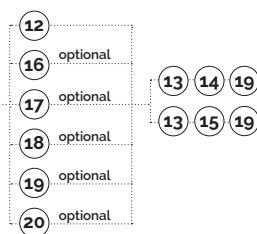

for the bench components, see page 249

aria

bench leg options

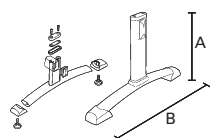

12 90gm-gamba mobile per panca con accessori 90gm-movable leg for bench with accessories

code	finishing	q.kit	q.pack	a	b	kg.x1	vol.x1
110703-005	● nero/black	x2	2	380	600	2,70	mc. 0.012
110704-002	● grigio/grey	x2	2	380	600	2,70	mc. 0.012
110710-001	● cromato/chrome	x2	2	380	600	2,70	mc. 0.012

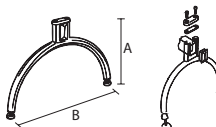

16 100gm-gamba mobile per panca con accessori 100gm-movable leg for bench with accessories

code	finishing	q.kit	q.pack	a	b	kg.x1	vol.x1
110703-008	● nero/black	x2	2	380	600	2,10	mc. 0.012
110704-004	● grigio/grey	x2	2	380	600	2,10	mc. 0.012
110710-005	● cromato/chrome	x2	2	380	600	2,10	mc. 0.012

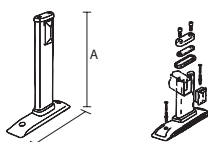

17 90gf-gamba fissa per panca con accessori 90gf-fixed leg for bench with accessories

code	finishing	q.kit	q.pack	a	b	kg.x1	vol.x1
110703-030	● nero/black	x2	2	380	310	1,90	mc. 0.006
110704-011	● grigio/grey	x2	2	380	310	1,90	mc. 0.006

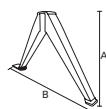

18 200gm-gamba mobile per panca con accessori 200gm-movable leg for bench with accessories

code	finishing	q.kit	q.pack	a	b	kg.x1	vol.x1
110703-110	● nero/black	x2	2	380	600	2,60	mc. 0.005
110704-112	● grigio/grey	x2	2	380	600	2,60	mc. 0.005
110710-110	● cromato/chrome	x2	2	380	600	2,60	mc. 0.005

OPTIONAL
bench connector



E-USB bench plug



JIM bench leg



APOLL bench arm



plastic

90GM bench leg



90GF bench leg



100GM bench leg



200GM bench leg



PIONEER bench arm



metal

CUT bench leg



SLIM bench leg



CUT bench arm



SLIM bench arm



aluminium

bench table options

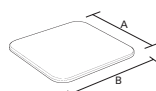
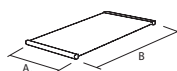
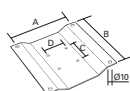

13 90ap-attacco porta piano 90ap-table attachment

code	finishing	q.kit	q.pack	a	b	c	d	kg.x1	vol.x1
110703-014	● nero/black	x1	25	170	200	65	55	1,00	mc. 0.002
110704-019	● grigio/grey	x1	25	170	200	65	55	1,00	mc. 0.002

14 aria-tavolo per panca in lamiera aria-metal sheet for bench

code	finishing	q.kit	q.pack	a	b	kg.x1	vol.x1
110703-069	● nero/black	x1	25	370	500	5,50	mc. 0.01
110704-030	● grigio/grey	x1	25	370	500	5,50	mc. 0.01

15 90tn-piano tavolo per panca 90tn-table for bench

code	finishing	q.kit	q.pack	a	b	kg.x1	vol.x1
120303-001	● nero/black	x1	10	400	400	2,20	mc. 0.002

19 vite tc+ m6x12 brunita nera screw tc+ m6x12 burnishing black

code	finishing	q.kit
117703-177	● nero/black	x4

aria

bench cut & slim version

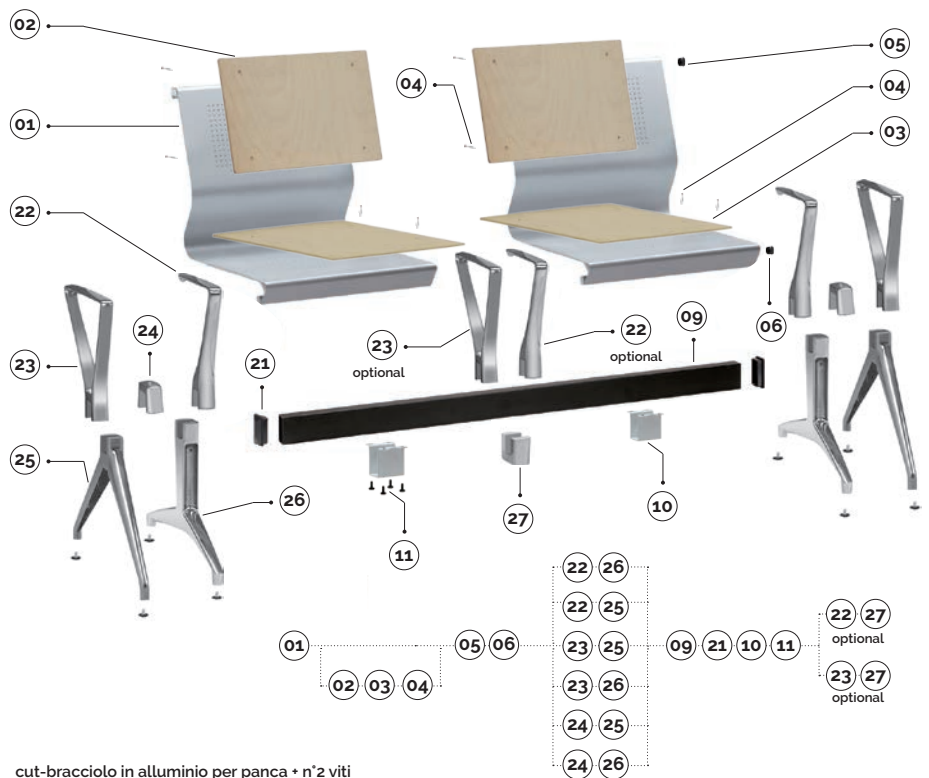

22 cut-bracciolo in alluminio per panca + n°2 viti
cut-aluminium arm for bench + n°2 screws

code	finishing	q.kit	q.pack	a	b	kg.x1	vol.x1
111704-223	● alluminio/aluminium	x1	10	300	305	1,48	mc. 0.0011

23 slim-bracciolo in alluminio per panca + n°2 viti
slim-aluminium arm for bench + n°2 screws

code	finishing	q.kit	q.pack	a	b	kg.x1	vol.x1
111704-225	● alluminio/aluminium	x1	10	325	305	1,35	mc. 0.0011

24 cut/slim-cavallotto in alluminio per gamba panca + n°2 viti
cut/slim-aluminium bracket 80x40 for bench leg + n°2 screws

code	finishing	q.kit	q.pack	a	b	kg.x1	vol.x1
111704-222	● alluminio/aluminium	x1	10	60	95	0,30	mc. 0.0012

25 slim-gamba in alluminio per gamba panca + n°2 piedini
slim-aluminium leg for bench + n°2 glides

code	finishing	q.kit	q.pack	a	b	kg.x1	vol.x1
111704-226	● alluminio/aluminium	x2	5	610	350	1,15	mc. 0.014

26 cut-gamba in alluminio per gamba panca + n°2 piedini
cut-aluminium leg for bench + n°2 glides

code	finishing	q.kit	q.pack	a	b	kg.x1	vol.x1
111704-224	● alluminio/aluminium	x2	5	610	350	2,55	mc. 0.014

21 tappo copritesta rettangolare 80x40 nero
rectangular cover head cap 80x40 black

code	finishing	q.kit
134103-001	● nero/black	x2

09 got(03) trave per panca 80x40
got(03) beam for bench 80x40

code	finishing		q.kit	q.pack	a	b	c	kg.x1	vol.x1
110703-190	● nero/black	2 posti / 2 seats	x1	1	1160	80	40	3,20	mc. 0.0045
110704-090	● grigio/grey	2 posti / 2 seats	x1	1	1160	80	40	3,20	mc. 0.0045
110703-191	● nero/black	3 posti / 3 seats	x1	1	1710	80	40	4,71	mc. 0.005
110704-091	● grigio/grey	3 posti / 3 seats	x1	1	1710	80	40	4,71	mc. 0.005
110703-192	● nero/black	4 posti / 4 seats	x1	1	2260	80	40	6,22	mc. 0.0085
110704-092	● grigio/grey	4 posti / 4 seats	x1	1	2260	80	40	6,22	mc. 0.0085
110703-193	● nero/black	5 posti / 5 seats	x1	1	2800	80	40	7,72	mc. 0.01
110704-193	● grigio/grey	5 posti / 5 seats	x1	1	2800	80	40	7,72	mc. 0.01

10 gocv-cavallotto sotto trave
gocv-support under beam

code	finishing	q.kit	q.pack	a	b	kg.x1	vol.x1
110703-007	● nero/black	x1	50	55	65	0,60	mc. 0.0005
110704-016	● grigio/grey	x1	50	55	65	0,60	mc. 0.0005

11 confezione viti m8x12 testa cilindrica a esagono incassato brunita nera
screws m8x12 cylindrical head hexagon embedded burnishing black package

code	finishing	q.kit	q.pack
117003-070	● nero/black	x4	200

27 cut/slim-cavallotto in alluminio per bracciolo panca
cut/slim-aluminium bracket 80x40 for bench arm

code	finishing	q.kit	q.pack	a	b	kg.x1	vol.x1
111704-221	● alluminio/aluminium	x1	10	58	95	0,27	mc. 0.0012



22



23

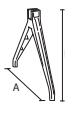

25

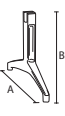

26

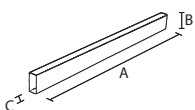

09



10



24



27

for the components below, see page 62

01 02 03 04 05 06

for the bench components, see page 249

OPTIONAL
bench
connector



E-USB **NEW**
bench plug



JIM **NEW**
bench leg



APOLL
bench arm



plastic

90GM
bench leg



90GF
bench leg



100GM
bench leg



200GM
bench leg



PIONEER
bench arm



metal

CUT
bench leg



SLIM
bench leg



CUT
bench arm



SLIM
bench arm



aluminium

main component sizes

optionals





BEYOND **Design**

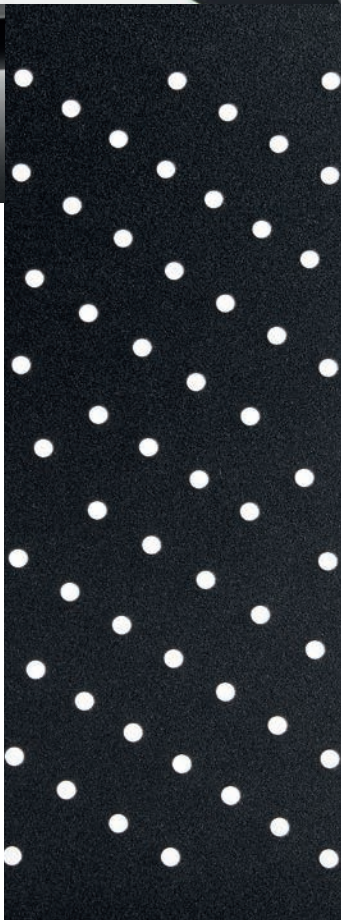
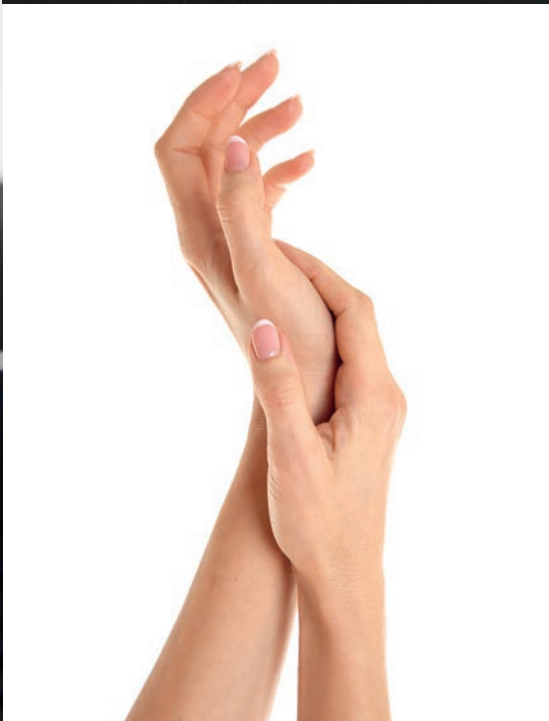



nexus



nexus

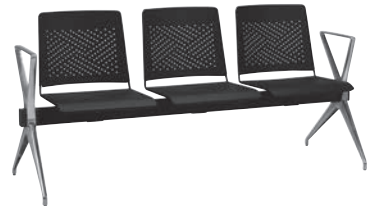
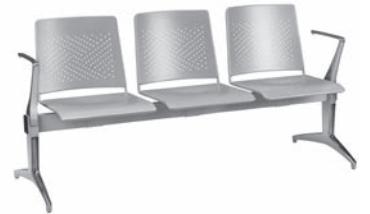

slide

4 legs

bench



EN 16139



EN 16139

nexus showing

tools



configurator



certification



brochure



video

features



designed by:
**esedra &
alessandrocrosera&partners**



trolley
available



La panca interamente in metallo.

Un pezzo unico, dal design essenziale, che garantisce una seduta comoda e molto stabile. Completano la famiglia i telai impilabili 4 gambe e slitta.

Plus:

- struttura innovativa, sviluppata in un unico pezzo e interamente in metallo;
- design distintivo, grazie soprattutto alla scocca traforata, interamente in metallo e disponibile in 4 finiture;
- funzionale e facile da pulire;
- qualità certificata CATAS.

Nexus è ideale per tutti gli **ambienti Community e Le Waiting Area**.

The all-metal bench.

A unique piece, with an essential design, which guarantees a comfortable and very stable seat. The family is completed by the stackable 4-legged and sled frames.

Advantages:

- innovative structure, developed in one piece and entirely in metal;
- distinctive design, thanks above all to the perforated seat shell, made entirely in metal and available in 4 finishes;
- functional and easy to clean;
- CATAS certified quality.

Nexus is ideal for all Community environments and Waiting Areas.

nexus

bench

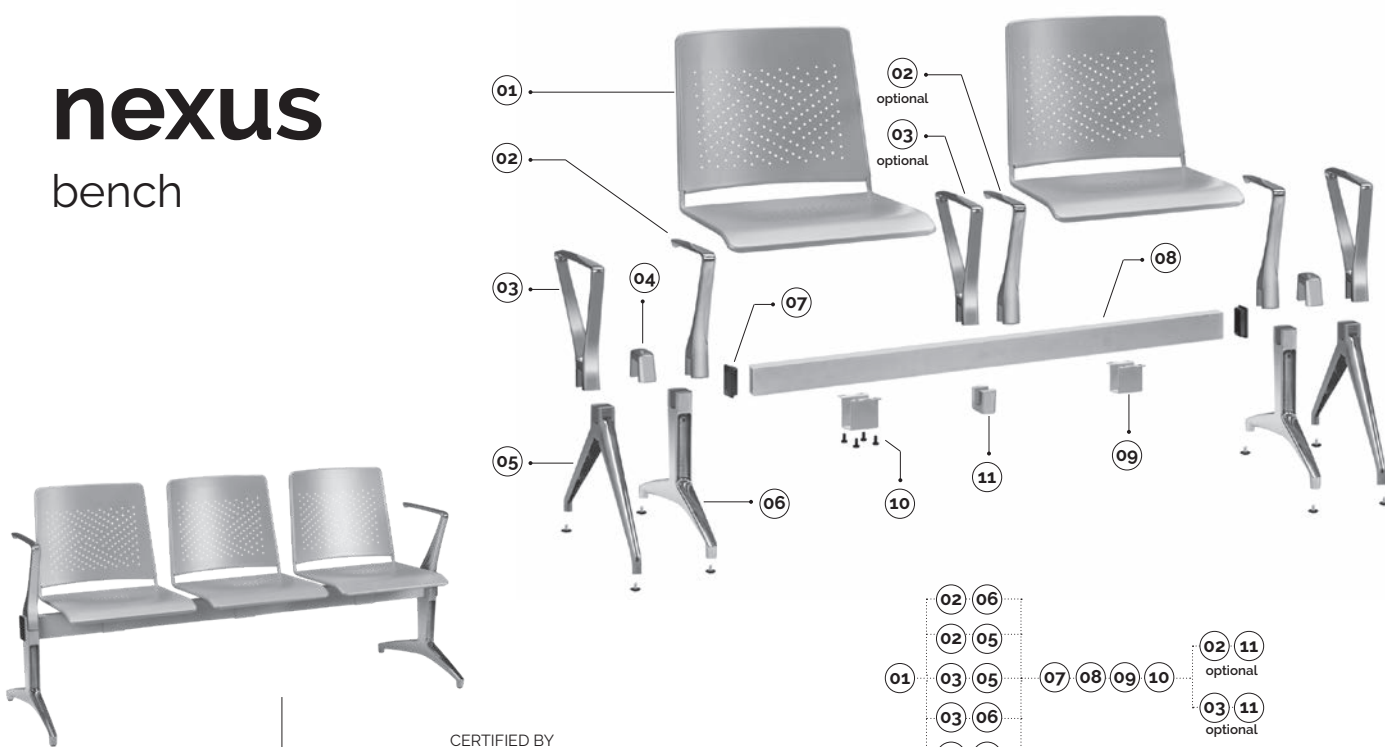

CERTIFIED BY
CATAS

Corten • *Specifica caratteristica del Corten è la variabilità nella tonalità della finitura.
* A specific characteristic of Corten is the variability in the tone of the finish.

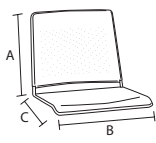

01

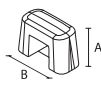

04

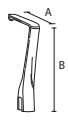

02

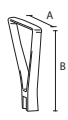

03

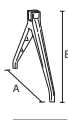

05

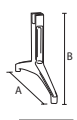

06

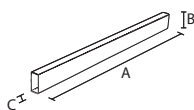

08



09



11

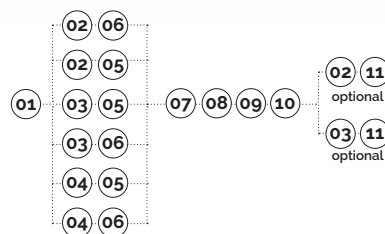

01 nexus-scocca in lamiera
nexus-shell metal sheet

code	finishing	q.kit	q.pack	a	b	c	kg.x1	vol.x1
110703-220	● nero/black	x1	60	405	454	545	7,60	mc. 0.02
110704-220	● grigio/grey	x1	60	405	454	545	7,60	mc. 0.02
110705-220	○ bianco/white ral9010	x1	60	405	454	545	7,60	mc. 0.02
110707-220	● corten*	x1	60	405	454	545	7,60	mc. 0.02

02 cut-bracciolo in alluminio per panca + n'2 viti
cut-aluminium arm for bench + n'2 screws

code	finishing	q.kit	q.pack	a	b	kg.x1	vol.x1
111704-223	● alluminio/aluminium	x1	10	300	305	1,40	mc. 0.0011

03 slim-bracciolo in alluminio per panca + n'2 viti
slim-aluminium arm for bench + n'2 screws

code	finishing	q.kit	q.pack	a	b	kg.x1	vol.x1
111704-225	● alluminio/aluminium	x1	10	325	305	1,40	mc. 0.0011

04 cut/slim-cavallotto in alluminio per gamba panca + n'2 viti
cut/slim-aluminium bracket 80x40 for bench leg + n'2 screws

code	finishing	q.kit	q.pack	a	b	kg.x1	vol.x1
111704-222	● alluminio/aluminium	x1	10	60	95	0,40	mc. 0.0012

05 slim-gamba in alluminio per gamba panca + n'2 piedini
slim-aluminium leg for bench + n'2 glides

code	finishing	q.kit	q.pack	a	b	kg.x1	vol.x1
111704-226	● alluminio/aluminium	x2	5	610	350	1,20	mc. 0.014

06 cut-gamba in alluminio per gamba panca + n'2 piedini
cut-aluminium leg for bench + n'2 glides

code	finishing	q.kit	q.pack	a	b	kg.x1	vol.x1
111704-224	● alluminio/aluminium	x2	5	610	350	2,55	mc. 0.014

07 tappo copritesta rettangolare 80x40 nero
rectangular cover head cap 80x40 black

code	finishing	q.kit
134103-001	● nero/black	x2

08 got(03) trave per panca 80x40
got(03) beam for bench 80x40

code	finishing	q.kit	q.pack	a	b	c	kg.x1	vol.x1
110703-190	● nero/black	2 posti / 2 seats	x1	1	1160	80	40	3,20 mc. 0.0045
110704-090	● grigio/grey	2 posti / 2 seats	x1	1	1160	80	40	3,20 mc. 0.0045
110703-191	● nero/black	3 posti / 3 seats	x1	1	1710	80	40	4,71 mc. 0.005
110704-091	● grigio/grey	3 posti / 3 seats	x1	1	1710	80	40	4,71 mc. 0.005
110703-192	● nero/black	4 posti / 4 seats	x1	1	2260	80	40	6,22 mc. 0.0085
110704-092	● grigio/grey	4 posti / 4 seats	x1	1	2260	80	40	6,22 mc. 0.0085
110703-193	● nero/black	5 posti / 5 seats	x1	1	2800	80	40	7,72 mc. 0.01
110704-193	● grigio/grey	5 posti / 5 seats	x1	1	2800	80	40	7,72 mc. 0.01

09 90cv-cavallotto sotto trave
90cv-support under beam

code	finishing	q.kit	q.pack	a	b	kg.x1	vol.x1
110703-007	● nero/black	x1	50	55	65	0,60	mc. 0.0005
110704-016	● grigio/grey	x1	50	55	65	0,60	mc. 0.0005

10 confezione viti m8x12 testa cilindrica a esagono incassato brunita nera
screws m8x12 cylindrical head hexagon embedded burnishing black package

code	finishing	q.kit	q.pack
117003-070	● nero/black	x4	200

11 cut/slim-cavallotto in alluminio per bracciolo panca
cut/slim-aluminium bracket 80x40 for bench arm

code	finishing	q.kit	q.pack	a	b	kg.x1	vol.x1
111704-221	● alluminio/aluminium	x1	10	58	95	0,32	mc. 0.0012

main component sizes

for the bench components, see page 249

nexus

bench leg options

• optional

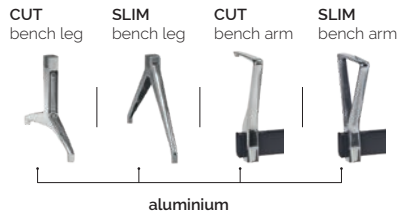
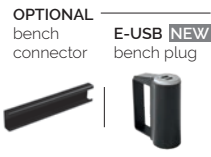

bench sizes

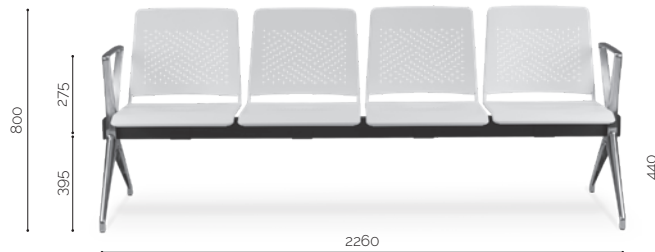
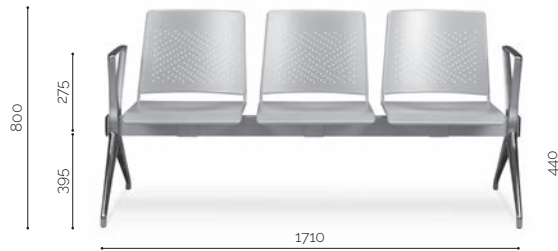
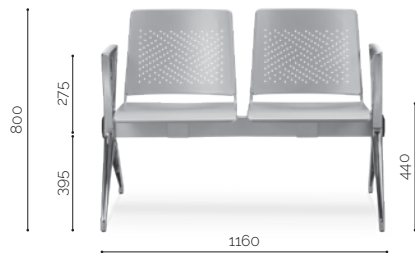

nexus

bench

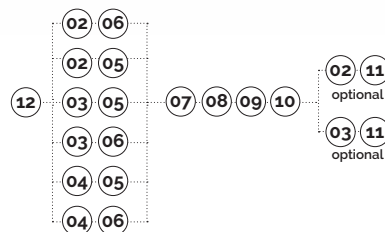
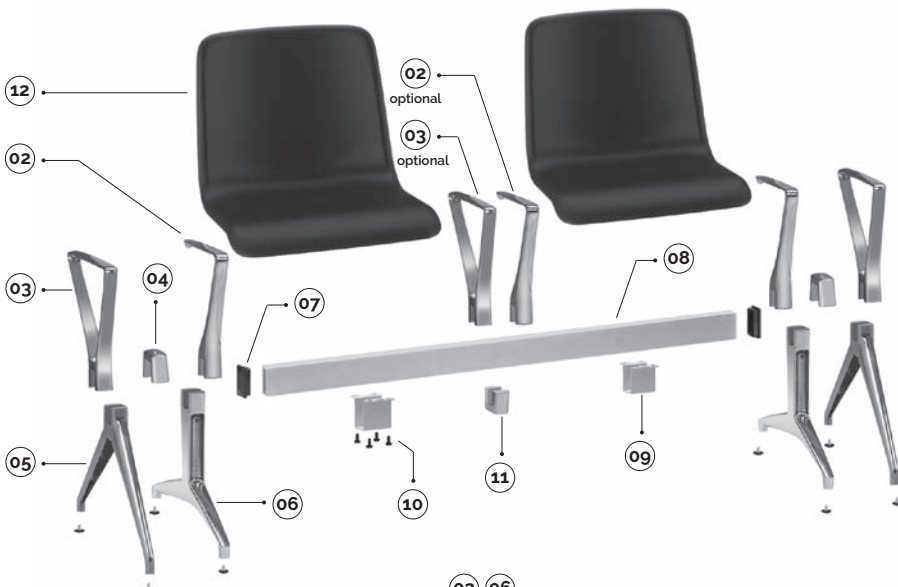

Disponibile in diversi colori mono/bi-colour per lotti da 100 pezzi

12 Available in different colours mono/bi-colour for batches from 100 pcs

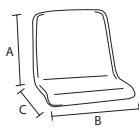

12

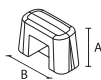

04



03



04

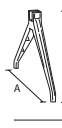

05

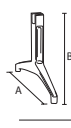

06

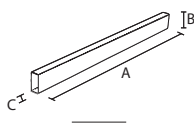

07

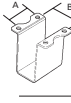

08

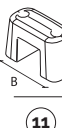

09



11

12 **nexus-scocca in poliuretano morbido freeform advanced**
nexus-half-soft polyurethane freeform advanced shell model

code	finishing	q.kit	q.pack	a	b	c	kg.x1	vol.x1
133903-061	● nero/black	x1		410	485	430	7,60	mc. 0.09

02 **cut-bracciolo in alluminio per panca + n'2 viti**
cut-aluminium arm for bench + n'2 screws

code	finishing	q.kit	q.pack	a	b	kg.x1	vol.x1
111704-223	● alluminio/aluminium	x1	10	300	305	1,40	mc. 0.0011

03 **slim-bracciolo in alluminio per panca + n'2 viti**
slim-aluminium arm for bench + n'2 screws

code	finishing	q.kit	q.pack	a	b	kg.x1	vol.x1
111704-225	● alluminio/aluminium	x1	10	325	305	1,40	mc. 0.0011

04 **cut/slim-cavallotto in alluminio per gamba panca + n'2 viti**
cut/slim-aluminium bracket 80x40 for bench leg + n'2 screws

code	finishing	q.kit	q.pack	a	b	kg.x1	vol.x1
111704-222	● alluminio/aluminium	x1	10	60	95	0,40	mc. 0.0012

05 **slim-gamba in alluminio per gamba panca + n'2 piedini**
slim-aluminium leg for bench + n'2 glides

code	finishing	q.kit	q.pack	a	b	kg.x1	vol.x1
111704-226	● alluminio/aluminium	x2	5	610	350	1,20	mc. 0.014

06 **cut-gamba in alluminio per gamba panca + n'2 piedini**
cut-aluminium leg for bench + n'2 glides

code	finishing	q.kit	q.pack	a	b	kg.x1	vol.x1
111704-224	● alluminio/aluminium	x2	5	610	350	2,55	mc. 0.014

07 **tappo copritesta rettangolare 80x40 nero**
rectangular cover head cap 80x40 black

code	finishing	q.kit
134103-001	● nero/black	x2

08 **got(03) trave per panca 80x40**
got(03) beam for bench 80x40

code	finishing		q.kit	q.pack	a	b	c	kg.x1	vol.x1
110703-190	● nero/black	2 posti / 2 seats	x1	1	1160	80	40	3,20	mc. 0.0045
110704-090	● grigio/grey	2 posti / 2 seats	x1	1	1160	80	40	3,20	mc. 0.0045
110703-191	● nero/black	3 posti / 3 seats	x1	1	1710	80	40	4,71	mc. 0.005
110704-091	● grigio/grey	3 posti / 3 seats	x1	1	1710	80	40	4,71	mc. 0.005
110703-192	● nero/black	4 posti / 4 seats	x1	1	2260	80	40	6,22	mc. 0.0085
110704-092	● grigio/grey	4 posti / 4 seats	x1	1	2260	80	40	6,22	mc. 0.0085
110703-193	● nero/black	5 posti / 5 seats	x1	1	2800	80	40	7,72	mc. 0.01
110704-193	● grigio/grey	5 posti / 5 seats	x1	1	2800	80	40	7,72	mc. 0.01

09 **gotc-cavallotto sotto trave**
gotc-support under beam

code	finishing	q.kit	q.pack	a	b	kg.x1	vol.x1
110703-007	● nero/black	x1	50	55	65	0,60	mc. 0.0005
110704-016	● grigio/grey	x1	50	55	65	0,60	mc. 0.0005

10 **confezione viti m8x12 testa cilindrica a esagono incassato brunita nera**
screws m8x12 cylindrical head hexagon embedded burnishing black package

code	finishing	q.kit	q.pack
117003-070	● nero/black	x4	200

11 **cut/slim-cavallotto in alluminio per bracciolo panca**
cut/slim-aluminium bracket 80x40 for bench arm

code	finishing	q.kit	q.pack	a	b	kg.x1	vol.x1
111704-221	● alluminio/aluminium	x1	10	58	95	0,32	mc. 0.0012

for the bench components, see page 249

nexus

polyurethane color options



PARTE ESTERNA - EXTERNAL PART

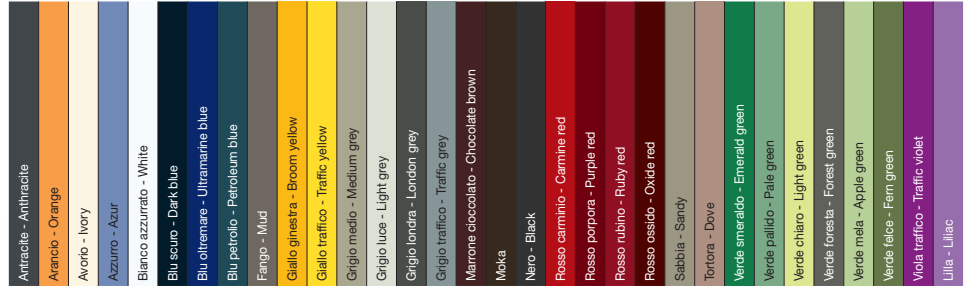

PARTE INTERNA - INNER PART	Antracite - Anthracite	Arancio - Orange	Avorio - Ivory	Azzurro - Azur	Bianco azzurrato - White	Blu scuro - Dark blue	Blu oltremare - Ultramarine blue	Blu petrolio - Petroleum blue	Fango - Mud	Giallo ginestra - Broom yellow	Giallo traffico - Traffic yellow	Grigio medio - Medium grey	Grigio luce - Light grey	Grigio Londra - London grey	Grigio traffico - Traffic grey	Marrone cioccolato - Chocolate brown	Moka	Nero - Black	Rosso carminio - Carmine red	Rosso porpora - Purple red	Rosso rubino - Ruby red	Rosso ossido - Oxide red	Sabbia - Sandy	Tortora - Dove	Verde smeraldo - Emerald green	Verde pallido - Pale green	Verde chiaro - Light green	Verde foresta - Forest green	Verde mela - Apple green	Verde felce - Fern green	Viola traffico - Traffic violet	Lilla - Lilac			
Antracite - Anthracite	•					•	•	•																											
Arancio - Orange	•	•				•	•	•																											
Avorio - Ivory	•	•	•	•		•	•	•	•	•																									
Azzurro - Azur	•			•		•	•	•																											
Bianco azzurrato - White	•	•		•	•	•	•	•	•	•																									
Blu scuro - Dark blue	•					•	•	•																											
Blu oltremare - Ultramarine blue	•					•	•	•																											
Blu petrolio - Petroleum blue	•					•	•	•																											
Fango - Mud	•					•	•	•	•																										
Giallo ginestra - Broom yellow	•			•		•	•	•	•	•																									
Giallo traffico - Traffic yellow	•					•	•	•			•																								
Grigio medio - Medium grey	•					•	•	•				•																							
Grigio luce - Light grey	•	•		•		•	•	•	•				•																						
Grigio Londra - London grey	•					•	•	•																											
Grigio traffico - Traffic grey	•					•	•	•																											
Marrone cioccolato - Chocolate brown	•					•	•	•																											
Moka	•					•	•	•																											
Nero - Black	•					•	•	•																											
Rosso carminio - Carmine red	•					•	•	•																											
Rosso porpora - Purple red	•					•	•	•																											
Rosso rubino - Ruby red	•					•	•	•																											
Rosso ossido - Oxide red	•					•	•	•																											
Sabbia - Sandy	•			•		•	•	•	•																										
Tortora - Dove	•					•	•	•																											
Verde smeraldo - Emerald green	•					•	•	•																											
Verde pallido - Pale green	•					•	•	•																											
Verde chiaro - Light green	•					•	•	•																											
Verde foresta - Forest green	•					•	•	•																											
Verde mela - Apple green	•					•	•	•																											
Verde felce - Fern green	•					•	•	•																											
Viola traffico - Traffic violet	•					•	•	•																											
Lilla - Lilac	•					•	•	•																											

COLORI - COLOURS

Antracite Anthracite	Simil RAL 7024
Arancio Orange	Simil PANT 7577/C
Avorio Ivory	Simil RAL 1013
Azzurro Azur	Simil PANT. 646/C
Bianco azzurrato White	Simil RAL 9016
Blu scuro Dark blue	Simil RAL 5008
Blu oltremare Ultramarine blue	RAL 5002
Blu petrolio Petroleum blue	PANT. 7477/C
Fango Mud	Simil PANT. 404/C

Giallo ginestra Broom yellow	RAL 1032
Giallo traffico Traffic yellow	RAL 1023
Grigio medio Medium grey	Simil PANT. 424/C
Grigio luce Light grey	RAL 7035
Grigio Londra London grey	Simil PANT. 418/C
Grigio traffico Traffic grey	Simil RAL 7042
Marrone cioccolato Chocolate brown	RAL 8017
Moka	Simil RAL 8019
Nero Black	RAL 9005

Rosso carminio Carmine red	RAL 3002
Rosso porpora Purple red	RAL 3004
Rosso rubino Ruby red	RAL 3003
Rosso ossido Oxide red	RAL 3009
Sabbia Sandy	Simil PANT. 7536/C
Tortora Dove	RAL 1019
Verde smeraldo Emerald green	RAL 6001
Verde pallido Pale green	RAL 6021
Verde chiaro Light green	RAL 6019

Verde foresta Forest green	PANT. 417/C
Verde mela Apple green	Simil PANT. 585/U
Verde felce Fern green	RAL 6025
Viola traffico Traffic violet	RAL 4006
Lilla Lilac	RAL 4005

quantità minima ordine: 100 pz. per colore
minimum order: 100 pieces per colour

nexus

4-legs

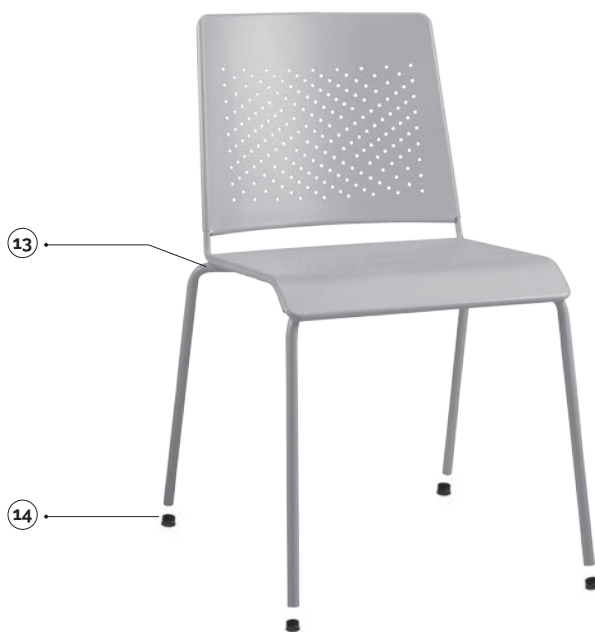

Corten *Specifica caratteristica del Corten è la variabilità nella tonalità della finitura.
* A specific characteristic of Corten is the variability in the tone of the finish.

13 14

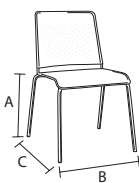

13

main component sizes

13 nexus-telaio 4 gambe con scocca in lamiera
nexus-4 legs frame with shell metal sheet

code	finishing	q.kit	q.pack	a	b	c	kg.x1	vol.x1
112603-070	● nero/black	x1	50	450	530	540	9,80	mc. 0,04
112604-070	● grigio/grey	x1	50	450	530	540	9,80	mc. 0,04
112605-070	○ bianco/white ral9010	x1	50	450	530	540	9,80	mc. 0,04
112607-070	● corten*	x1	50	450	530	540	9,80	mc. 0,04

14 puntale alettato tondo d.18 nero
inner cap for legs d.18 black

code	finishing	q.kit	q.pack
137003-072	● nero/black	x4	200



nexus-carrello portasedie con accessori nero
nexus-trolley for chairs with accessories black

code	finishing	q.kit
110803-342	● nero/black	x1

nexus

slide

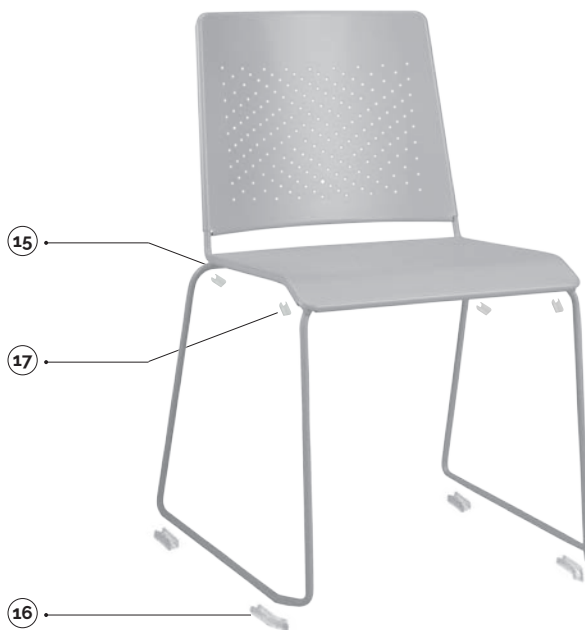

Corten ● *Specifica caratteristica del Corten è la variabilità nella tonalità della finitura.
* A specific characteristic of Corten is the variability in the tone of the finish.

15 16 17

main component sizes

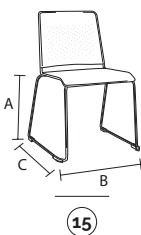

15

15 nexus-telaio slitta in tondino con scocca in lamiera
nexus-slide wire frame with shell metal sheet

code	finishing	q.kit	q.pack	a	b	c	kg.x1	vol.x1
113403-010	● nero/black	x1	50	450	520	565	8,20	mc. 0,04
113404-010	● grigio/grey	x1	50	450	520	565	8,20	mc. 0,04
113405-010	○ bianco/white ral9010	x1	50	450	520	565	8,20	mc. 0,04
113407-010	● corten*	x1	50	450	520	565	8,20	mc. 0,04

16 btf-kit piedini
btf-kit feet

code	finishing	q.kit	q.pack	kg.x1
134306-001	○ neutro/neutral	x1	100	0,05

17 confezione di basi a pinza antirotazione per tondino colore neutro
neutral clips base for wire d.11 package

code	finishing	q.kit	q.pack
137006-070	○ neutro/neutral	x4	200

optional



16



17





BEYOND **Innovation**





siton



siton



bench

siton showing

features



designed by:
esedra



La panca con seduta ribaltabile.

Pensata per tutte quelle situazioni in cui non si vuole rinunciare all'eleganza, **Siton** presenta un meccanismo in alluminio per sedile ribaltabile, disegnato e realizzato per essere esso stesso un elemento di stile.

Plus:

- design distintivo;
- meccanismo in alluminio ribaltabile.

Siton è ideale per gli **auditorium e le sale conferenza piu prestigiose.**

Bench featuring a tip-up seat.

*Designed for all those situations where a touch of elegance is required, **Siton** features an aluminium folding seat mechanism, designed and produced to be a style element in itself.*

Advantages:

- distinctive design;
- aluminium folding mechanism.

Siton is ideal for the **most prestigious auditoriums and conference rooms.**

siton

bench

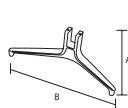
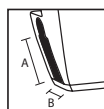
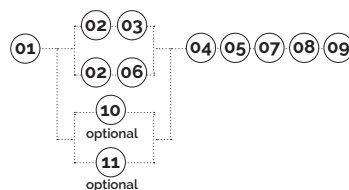

01

02

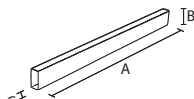

03

04



05

06

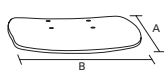

07

08



09

01 siton-mecanismo panca ribaltabile alluminio lucido
siton-polished aluminium folding mechanism

code	finishing	q.kit	q.pack	a	b	kg.x1	vol.x1
110704-180	● alluminio/aluminium	x1	4	80	40	2.81	mc. 0.007

02 siton-gamba lunga in alluminio per panca
siton-long aluminium leg for bench

code	finishing	q.kit	q.pack	a	b	kg.x1	vol.x1
110704-171	● alluminio/aluminium	x2	5	305	643	2.80	mc. 0.014

03 siton-bracciolo in alluminio per panca
siton-aluminium arm for bench

code	finishing	q.kit	q.pack	a	b	kg.x1	vol.x1
111704-030	● alluminio/aluminium	x1	10	280	303	1.30	mc. 0.0011

04 got(03) trave per panca 80x40
got(03) beam for bench 80x40

code	finishing	q.kit	q.pack	a	b	c	kg.x1	vol.x1	
110703-190	● nero/black	2 posti / 2 seats	x1	1	1160	80	40	3.20	mc. 0.0045
110704-190	● grigio/grey	2 posti / 2 seats	x1	1	1160	80	40	3.20	mc. 0.0045
110703-191	● nero/black	3 posti / 3 seats	x1	1	1710	80	40	4.71	mc. 0.005
110704-191	● grigio/grey	3 posti / 3 seats	x1	1	1710	80	40	4.71	mc. 0.005
110703-192	● nero/black	4 posti / 4 seats	x1	1	2260	80	40	6.22	mc. 0.0085
110704-192	● grigio/grey	4 posti / 4 seats	x1	1	2260	80	40	6.22	mc. 0.0085
110703-193	● nero/black	5 posti / 5 seats	x1	1	2800	80	40	7.72	mc. 0.01
110704-193	● grigio/grey	5 posti / 5 seats	x1	1	2800	80	40	7.72	mc. 0.01

05 siton-cavalletto in alluminio 80x40 per bracciolo panca
siton-aluminium bracket 80x40 for bench arm

code	finishing	q.kit	q.pack	kg.x1	vol.x1
111704-031	● alluminio/aluminium	x1	10	0.485	mc. 0.0012

06 siton-coperchio in alluminio per gamba panca
siton-aluminium cover for bench leg

code	finishing	q.kit	q.pack	kg.x1	vol.x1
110704-172	● alluminio/aluminium	x2	10	0.113	mc. 0.0002

07 siton-kit di dieci confezioni accessori per gamba panca
siton-ten packs accessories kit for leg bench

code	finishing	q.kit	q.pack	kg.x1	vol.x1
137000-005	● alluminio/aluminium	x1	1	0.85	mc. 0.004

08 siton-sedile per panca ribaltabile in legno verniciato + 4 testine e 4 viti fissaggio
siton-folding bench seat, varnished beechwood + 4 tunes and screws for fixing

code	finishing	q.kit	q.pack	a	b	kg.x1	vol.x1
122207-030	● faggio/beech	x1	10	420	400	1.40	mc. 0.01
122207-031	● wengè/wengè	x1	10	420	400	1.40	mc. 0.01

09 siton.schienale per panca ribaltabile in legno verniciato + 4 viti fissaggio
siton-folding bench back, varnished beechwood + 4 tunes and screws for fixing

code	finishing	q.kit	q.pack	a	b	kg.x1	vol.x1
122107-030	● faggio/beech	x1	10	690	460	3.30	mc. 0.02
122107-031	● wengè/wengè	x1	10	690	460	3.30	mc. 0.02

siton

bench leg options

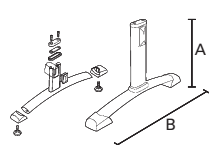

10 90gm(02)-gamba mobile per panca con accessori
90gm(02)-movable leg for bench with accessories

code	finishing	q.kit	q.pack	a	b	kg.x1	vol.x1
110703-120	● nero/black	x2	2	320	600	2,70	mc. 0,0012
110704-099	● grigio/grey	x2	2	320	600	2,70	mc. 0,0012
110710-007	● cromato/chrome	x2	2	320	600	2,70	mc. 0,0012

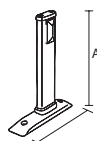

11 90gf(02)-gamba fissa per panca con accessori
90gf(02)-fixed leg for bench with accessories

code	finishing	q.kit	q.pack	a	b	kg.x1	vol.x1
110703-122	● nero/black	x2	2	320	310	1,80	mc. 0,0012
110704-107	● grigio/grey	x2	2	320	310	1,80	mc. 0,0012





BEYOND | **Solutions**





young / key / fabric



young / key / fabric



side

4 legs

4 legs with castors

swivel

bench

young/key/fabric showing



tools



configurator



brochure



video



Young, Key e Fabric, le nuove scocche in legno multistrato di faggio.

Tre scocche dal design distintivo, con foro centrale, a T o da tappezzare, tutte compatibili con i telai della famiglia Magix, in grado di consentire il massimo delle combinazioni.

Plus:

- scocca in legno multistrato di faggio;
- 5 colorazioni disponibili della scocca a vista;
- linea ergonomica;
- massima versatilità;
- la versione da tappezzare permette l'unicità di finitura.

Young, Key e Fabric sono ideali per l'ambiente Office.

Young, Key and Fabric, the new seat shells in beech plywood.

Three seat shells with a distinctive design, with central hole, T-shaped or to be upholstered, all compatible with the frames in the Magix family, thus providing an extensive range of combinations.

Advantages:

- seat shell in beech plywood;
- seat shell available in 5 colours;
- ergonomic shape;
- maximum versatility;
- the version to be upholstered enables a unique look to be achieved.

Young, Key and Fabric are ideal for Office environments.

young slide

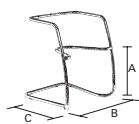
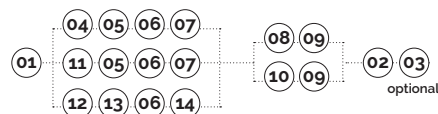

01

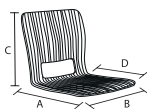

04

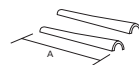

08



03



02

01 magix-base a slitta in tubo asform d.25 tappi esclusi
magix-slide frame pipe d.25 without caps

code	finishing	q.kit	q.pack	a	b	c	kg.x1	vol.x1
110503-009	● nero/black	x1	48	450	560	560	4,90	mc. 0,045
110504-112	● grigio/grey	x1	48	450	560	560	4,90	mc. 0,045
110510-095	● cromato/chrome	x1	48	450	560	560	4,90	mc. 0,045

02 magix-confezione accessori 50 picma + 290 p2pa
magix-pack of accessories 50 picma + 290 p2pa

code	finishing	q.kit	q.pack	kg.x1	vol.x1
137000-009	● nero/black	x1+x6	50+290	1,00	mc. 0,1413

03 piedino antibaltamento in plastica nero + viti
plastic black feet anti-upsetting + screws

code	finishing	q.kit	q.pack	kg.x1	vol.x1
134303-006	● nero/black	x2	100	0,025	mc. 0,0001

04 magix/young-monoscocca mult. ver. c/inserti
magix/young beech shell w/inserts

code	finishing	q.kit	q.pack	a	b	c	d	kg.x1	vol.x1
122107-015	● faggio/plywood	x1	5	556	487	396	396	3,11	mc. 0,0312
122115-015	● azzurro/blue	x1	5	556	487	396	396	3,11	mc. 0,0312
122116-015	● verde/green	x1	5	556	487	396	396	3,11	mc. 0,0312
122104-015	● tempesta/grey blue	x1	5	556	487	396	396	3,11	mc. 0,0312
122107-021	● arancione/orange	x1	5	556	487	396	396	3,11	mc. 0,0312

05 vite 4,8 tsp+ m6x30-zincata per il sedile
screw 4,8 tsp+ m6x30-zinc for the seat

code	finishing	q.kit
117711-192	○ zincata/zinc	x4

06 supporto schienale scocca legno
spacer for plywood shell

code	finishing	q.kit	q.pack	kg.x1	vol.x1
132103-077	● nero/black	x1	20	0,26	mc. 0,055
132105-077	○ avorio/ivory ral1013	x1	20	0,26	mc. 0,055

07 vite tspei m5x40 zincata bianca per lo schienale
screw tspei m5x40 white zinc for the back

code	finishing	q.kit
117711-154	○ zincata bianca/white zinc	x3

08 bracciolo destro e sinistro plastica conico
left right black plastic conic arm

code	finishing	q.kit	q.pack	a	kg.x1	vol.x1
131703-041	● nero/black	x2	200	205	0,04	mc. 0,0002
131703-042	○ avorio/ivory ral1013	x2	200	205	0,04	mc. 0,0002

09 confezioni viti trucciolari tsp+ d.4x25 zincate (per fissare braccioli)
shaving screws tsp+ d.4x25 zinc package (for arms)

code	finishing	q.kit	q.pack
117011-072	○ zincata/zinc	x4	200

main component sizes

optional

young

slide/armrest option

main component sizes

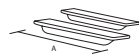

10



10 bracciolo destro e sinistro plastica nero
left right black plastic arm

code	finishing	q.kit	q.pack	a	kg.x1	vol.x1
131703-040	● nero/black	x2	100	200	0,04	mc. 0.0004

slide/shell options

main component sizes

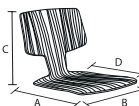

11



11 magix/key-monoscocca mult. ver. c/inserti
magix/key beech shell w/inserts

code	finishing	q.kit	q.pack	a	b	c	d	kg.x1	vol.x1
122107-016	● faggio/plywood	x1	5	552	483	398	391	2,76	mc. 0.0312
122115-016	● azzurro/blue	x1	5	552	483	398	391	2,76	mc. 0.0312
122116-016	● verde/green	x1	5	552	483	398	391	2,76	mc. 0.0312
122104-016	● tempesta/grey blue	x1	5	552	483	398	391	2,76	mc. 0.0312
122107-022	● arancione/orange	x1	5	552	483	398	391	2,76	mc. 0.0312

and 05 07

spessore 11mm
thickness 11mm

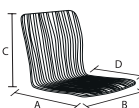

12



12 magix/fabric-monosc. mult. faggio x imbottiti c/inserti
magix/fabric beech shell for upholstery w/inserts

code	finishing	q.kit	q.pack	a	b	c	d	kg.x1	vol.x1
122107-017	● faggio/plywood	x1	5	556	487	396	396	3,50	mc. 0.0312

13 vite 4.8 tsp+ m6x35 zincata bianca per il sedile
screw 4.8 tsp+ m6x35-white zinc for the seat

code	finishing	q.kit
117711-183	● zincata bianca/white zinc	x4

14 vite tspei m5x45 zincata bianca per lo schienale
screw tspei m5x45 white zinc for the back

code	finishing	q.kit
117711-156	● zincata bianca/white zinc	x3

spessore 11mm
thickness 11mm

key

4-legs

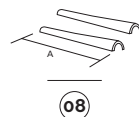
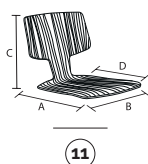
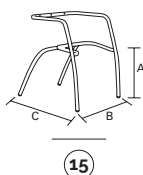
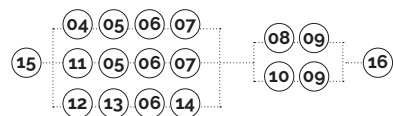
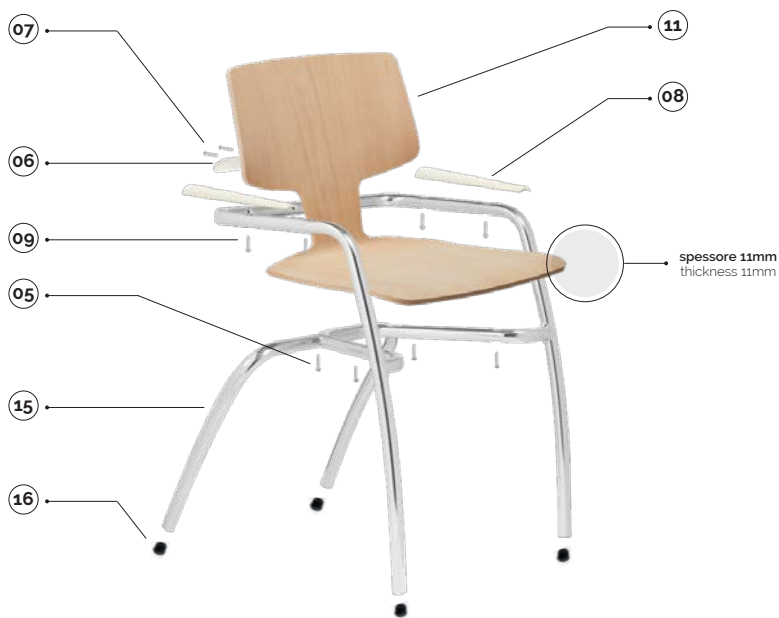

main component sizes

15 magix-telaio quattro gambe d.25 senza tappi magix-four legs frame d.25 without caps

code	finishing	q.kit	q.pack	a	b	c	kg.x1	vol.x1
110103-006	● nero/black	x1	30	450	550	550	4.10	mc. 0.045
110104-006	● grigio/grey	x1	30	450	550	550	4.10	mc. 0.045
110110-006	● cromato/chrome	x1	30	450	550	550	4.10	mc. 0.045

16 confezione puntali a testa sferica d.25 cap d.25 spherical head black package

code	finishing	q.kit	q.pack
137003-075	● nero/black	x4	120

11 magix/key-monoscocca mult. ver. c./inserti magix/key beech shell w/inserts

code	finishing	q.kit	q.pack	a	b	c	d	kg.x1	vol.x1
122107-016	● faggio/plywood	x1	5	552	483	398	391	2.76	mc. 0.0312
122115-016	● azzurro/blue	x1	5	552	483	398	391	2.76	mc. 0.0312
122116-016	● verde/green	x1	5	552	483	398	391	2.76	mc. 0.0312
122104-016	● tempesta/grey blue	x1	5	552	483	398	391	2.76	mc. 0.0312
122107-022	● arancione/orange	x1	5	552	483	398	391	2.76	mc. 0.0312

05 vite 4.8 tsp+ m6x30-zincata per il sedile screw 4.8 tsp+ m6x30-zinc for the seat

code	finishing	q.kit
117711-192	○ zincata/zinc	x4

06 supporto schienale scocca legno spacer for plywood shell

code	finishing	q.kit	q.pack	kg.x1	vol.x1
132103-077	● nero/black	x1	20	0.26	mc. 0.055
132105-077	○ avorio/ivory rat1013	x1	20	0.26	mc. 0.055

07 vite tspei m5x40 zincata bianca per lo schienale screw tspei m5x40 white zinc for the back

code	finishing	q.kit
117711-154	○ zincata bianca/white zinc	x3

08 bracciolo destro e sinistro plastica conico left right black plastic conic arm

code	finishing	q.kit	q.pack	a	kg.x1	vol.x1
131703-041	● nero/black	x2	200	205	0.04	mc. 0.0002
131703-042	○ avorio/ivory rat1013	x2	200	205	0.04	mc. 0.0002

09 confezioni viti trucciolari tsp+ d.4x25 zincate (per fissare braccioli) shaving screws tsp+ d.4x25 zinc package (for arms)

code	finishing	q.kit	q.pack
117011-072	○ zincata/zinc	x4	200

key

4-legs/armrest option

main component sizes

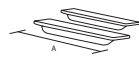

10



10 bracciolo destro e sinistro plastica nero left right black plastic arm

code	finishing	q.kit	q.pack	a	kg.x1	vol.x1
131703-040	● nero/black	x2	100	200	0,04	mc. 0.0004

4-legs/shell options

main component sizes

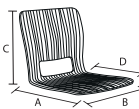

04



spessore 11mm
thickness 11mm

04 magix/young-monoscocca mult. ver. c/inserti magix/young beech shell w/inserts

code	finishing	q.kit	q.pack	a	b	c	d	kg.x1	vol.x1
122107-015	● faggio/plywood	x1	5	556	487	396	396	3,11	mc. 0.0312
122115-015	● azzurro/blue	x1	5	556	487	396	396	3,11	mc. 0.0312
122116-015	● verde/green	x1	5	556	487	396	396	3,11	mc. 0.0312
122104-015	● tempesta/grey blue	x1	5	556	487	396	396	3,11	mc. 0.0312
122107-021	● arancione/orange	x1	5	556	487	396	396	3,11	mc. 0.0312

and 05 07

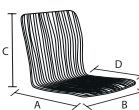

12



spessore 11mm
thickness 11mm

12 magix/fabric-monosc. mult. faggio x imbottiti c/inserti magix/fabric beech shell for upholstery w/inserts

code	finishing	q.kit	q.pack	a	b	c	d	kg.x1	vol.x1
122107-017	● faggio/plywood	x1	5	556	487	396	396	3,50	mc. 0.0312

13 vite 4.8 tsp+ m6x35 zincata bianca per il sedile screw 4.8 tsp+ m6x35-white zinc for the seat

code	finishing	q.kit
117711-183	● zincata bianca/white zinc	x4

14 vite tspei m5x45 zincata bianca per lo schienale screw tspei m5x45 white zinc for the back

code	finishing	q.kit
117711-156	● zincata bianca/white zinc	x3

key

4-legs for castors

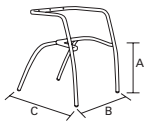
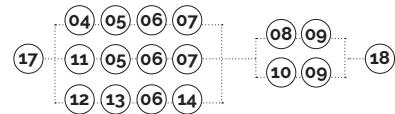

17

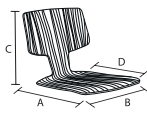

11

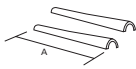

08

main component sizes

17 magix-telaio quattro gambe per ruote d.25 con riduttori
magix-four legs frame for castors d.25 with adapter

code	finishing	q.kit	q.pack	a	b	c	kg.x1	vol.x1
110103-005	● nero/black	x1	30	450	550	550	3,90	mc. 0,045
110104-005	● grigio/grey	x1	30	450	550	550	3,90	mc. 0,045
110110-005	● cromato/chrome	x1	30	450	550	550	3,90	mc. 0,045

18 doppia ruota d.50 in desmopan con perno montato
twin wheel castor d.50 desmopan with pivot mounted

code	finishing	q.kit
134403-003	● nero/black	x4

11 magix/key-monoscocca mult. ver. c/inserti
magix/key beech shell w/inserts

code	finishing	q.kit	q.pack	a	b	c	d	kg.x1	vol.x1
122107-016	● faggio/plywood	x1	5	552	483	398	391	2,76	mc. 0,0312
122115-016	● azzurro/blue	x1	5	552	483	398	391	2,76	mc. 0,0312
122116-016	● verde/green	x1	5	552	483	398	391	2,76	mc. 0,0312
122104-016	● tempesta/grey blue	x1	5	552	483	398	391	2,76	mc. 0,0312
122107-022	● arancione/orange	x1	5	552	483	398	391	2,76	mc. 0,0312

05 vite 4.8 tsp+ m6x30-zincata per il sedile
screw 4.8 tsp+ m6x30-zinc for the seat

code	finishing	q.kit
117711-192	○ zincata/zinc	x4

06 supporto schienale scocca legno
spacer for plywood shell

code	finishing	q.kit	q.pack	kg.x1	vol.x1
132103-077	● nero/black	x1	20	0,26	mc. 0,055
132105-077	○ avorio/ivory ral1013	x1	20	0,26	mc. 0,055

07 vite tspei m5x40 zincata bianca per lo schienale
screw tspei m5x40 white zinc for the back

code	finishing	q.kit
117711-154	○ zincata bianca/white zinc	x3

08 bracciolo destro e sinistro plastica conico
left right black plastic conic arm

code	finishing	q.kit	q.pack	a	kg.x1	vol.x1
131703-041	● nero/black	x2	200	205	0,04	mc. 0,0002
131703-042	○ avorio/ivory ral1013	x2	200	205	0,04	mc. 0,0002

09 confezioni viti trucciolari tsp+ d.4x25 zincate (per fissare braccioli)
shaving screws tsp+ d.4x25 zinc package (for arms)

code	finishing	q.kit	q.pack
117011-072	○ zincata/zinc	x4	200

key

4-legs/armrest option

main component sizes

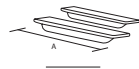

10



10 bracciolo destro e sinistro plastica nero
left right black plastic arm

code	finishing	q.kit	q.pack	a	kg.x1	vol.x1
131703-040	● nero/black	x2	100	200	0,04	mc. 0.0004

4-legs/shell options

main component sizes

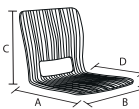

04



spessore 11mm
thickness 11mm

04 magix/young-monoscocca mult. ver. c/inserti
magix/young beech shell w/inserts

code	finishing	q.kit	q.pack	a	b	c	d	kg.x1	vol.x1
122107-015	● faggio/plywood	x1	5	556	487	396	396	3,11	mc. 0.0312
122115-015	● azzurro/blue	x1	5	556	487	396	396	3,11	mc. 0.0312
122116-015	● verde/green	x1	5	556	487	396	396	3,11	mc. 0.0312
122104-015	● tempesta/grey blue	x1	5	556	487	396	396	3,11	mc. 0.0312
122107-021	● arancione/orange	x1	5	556	487	396	396	3,11	mc. 0.0312

and 05 07

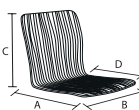

12



spessore 11mm
thickness 11mm

12 magix/fabric-monosc. mult. faggio x imbottiti c/inserti
magix/fabric beech shell for upholstery w/inserts

code	finishing	q.kit	q.pack	a	b	c	d	kg.x1	vol.x1
122107-017	● faggio/plywood	x1	5	556	487	396	396	3,50	mc. 0.0312

13 vite 4.8 tsp+ m6x35 zincata bianca per il sedile
screw 4.8 tsp+ m6x35-white zinc for the seat

code	finishing	q.kit
117711-183	● zincata bianca/white zinc	x4

14 vite tspei m5x45 zincata bianca per lo schienale
screw tspei m5x45 white zinc for the back

code	finishing	q.kit
117711-156	● zincata bianca/white zinc	x3

fabric

swivel

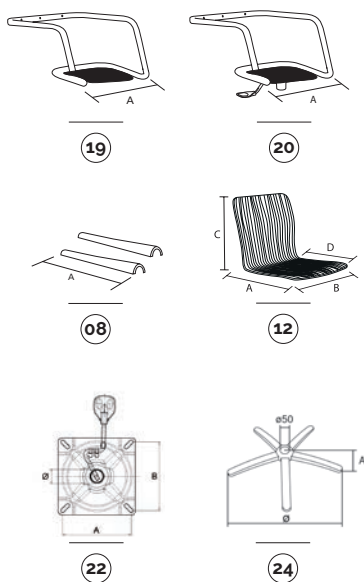
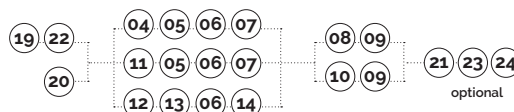

main component sizes

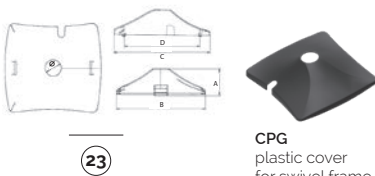

CPG
plastic cover
for swivel frame

19 magix-telaio girevole d.25 con braccioli senza tappi magix-d.25 swivel metal frame arms without caps

code	finishing	q.kit	q.pack	a	kg.x1	vol.x1
110910-034	● cromato/chrome	x1	50	550	5,00	mc. 0.045

20 magix(01)gc-telaio girevole d.25 con braccioli senza tappi con piastra saldata + spatola magix(01)gc-d.25 swivel metal frame arms without caps with gas plate welded + paddle

code	finishing	q.kit
110910-033	● cromato/chrome	x1 50 550

21 tappo copritesta alettato d.25 nero cover head d.25 black

code	finishing	q.kit
134103-250	● nero/black	x2

12 magix/fabric-monosc. mult. faggio x imbottiti c/inserti magix/fabric beech shell for upholstery w/inserts

code	finishing	q.kit	q.pack	a	b	c	d	kg.x1	vol.x1
122107-017	● faggio/plywood	x1	5	556	487	396	396	3,50	mc. 0.0312

13 vite 4.8 tsp+ m6x35 zincata bianca per il sedile screw 4.8 tsp+ m6x35-white zinc for the seat

code	finishing	q.kit
117711-183	○ zincata bianca/white zinc	x4

14 vite tspei m5x45 zincata bianca per lo schienale screw tspei m5x45 white zinc for the back

code	finishing	q.kit
117711-156	○ zincata bianca/white zinc	x3

06 supporto schienale scocca legno spacer for plywood shell

code	finishing	q.kit	q.pack	kg.x1	vol.x1
132103-077	● nero/black	x1	20	0,26	mc. 0.055
132105-077	○ avorio/ivory ral1013	x1	20	0,26	mc. 0.055

08 bracciolo destro e sinistro plastica conico left right black plastic conic arm

code	finishing	q.kit	q.pack	a	kg.x1	vol.x1
131703-041	● nero/black	x2	200	205	0,04	mc. 0.0002
131703-042	○ avorio/ivory ral1013	x2	200	205	0,04	mc. 0.0002

09 confezioni viti trucciolari tsp+ d.4x25 zincate (per fissare braccioli) shaving screws tsp+ d.4x25 zinc package (for arms)

code	finishing	q.kit	q.pack
117011-072	○ zincata/zinc	x4	200

22 pss28nr-piastra sgabello c/spat. c/28 3' l4 nera pss28nr- square metal plate with straight lever c/28 3' l4

code	finishing	q.kit	q.pack	a	b	o	kg.x1	vol.x1
113003-104	● nero/black	x1	25	150	150	28	1,23	mc. 0.002

23 cpg-copertina in plastica per telaio girevole cpg-plastic cover for swivel frame

code	finishing	q.kit	q.pack	a	b	c	d	o	kg.x1	vol.x1
130903-000	● nero/black	x1	50	60	200	210	167	36	0,1	mc. 0.0015

24 b40 base in metallo d.640 con coprisaldatura b40 metal base d.640 with cover welding

code	finishing	q.kit	q.pack	a	o	kg.x1	vol.x1
110210-027	● cromato/chrome	x1	5	60	640	2,85	mc. 0.014

young / key / fabric

bench

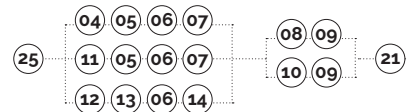

25 magix-telaio panca d.25 con braccioli senza tappi
magix-d.25 bench metal frame arms without caps

code	finishing	q.kit	q.pack	a	kg.x1	vol.x1
110710-200	● cromato/chrome	x1	60	550	5,00	mc. 0,045

26 got(03) trave per panca 80x40
got(03) beam for bench 80x40

code	finishing		q.kit	q.pack	a	b	c	kg.x1	vol.x1
110703-190	● nero/black	2 posti/2 seats	x1	1	1160	80	40	3,20	mc. 0,0045
110704-190	● grigio/grey	2 posti/2 seats	x1	1	1160	80	40	3,20	mc. 0,0045
110703-191	● nero/black	3 posti/3 seats	x1	1	1710	80	40	4,71	mc. 0,005
110704-191	● grigio/grey	3 posti/3 seats	x1	1	1710	80	40	4,71	mc. 0,005
110703-192	● nero/black	4 posti/4 seats	x1	1	2260	80	40	6,22	mc. 0,0085
110704-192	● grigio/grey	4 posti/4 seats	x1	1	2260	80	40	6,22	mc. 0,0085
110703-193	● nero/black	5 posti/5 seats	x1	1	2800	80	40	7,72	mc. 0,01
110704-197	● grigio/grey	5 posti/5 seats	x1	1	2800	80	40	7,72	mc. 0,01

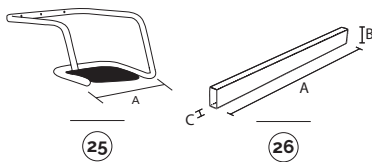

for the components below, see page 86

04 05 06 07 08 09

for the components below, see page 90

11

for the components below, see page 92

12 13 14 21

for the bench components, see page 249

bench/armrest option



10 bracciolo destro e sinistro plastica nero
left right black plastic arm

code	finishing	q.kit	q.pack	a	kg.x1	vol.x1
131703-040	● nero/black	x2	100	200	0,04	mc. 0,0004

OPTIONAL
bench
connector

E-USB NEW
bench plug

JIM NEW
bench leg

APOLL
bench arm

90GM
bench leg

90GF
bench leg

100GM
bench leg

200GM
bench leg

PIONEER
bench arm

CUT
bench leg

SLIM
bench leg

CUT
bench arm

SLIM
bench arm



plastic

metal

aluminium

main component sizes

optionals

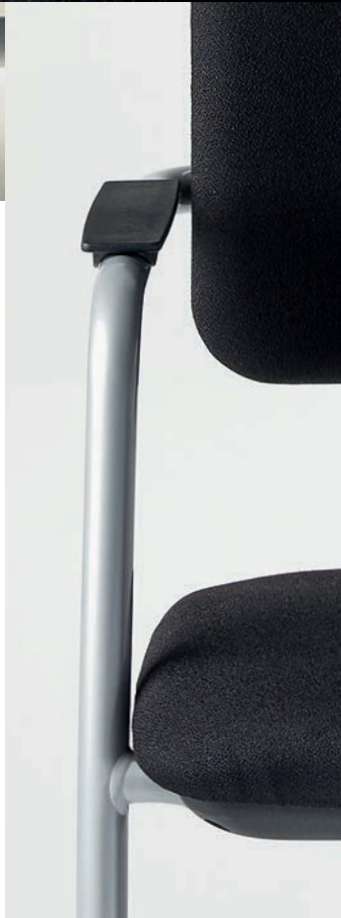



magix



magix



slide

4 legs

4 legs with castors

swivel

bench



EN 16139

magix showing



tools



certification



La seduta dai caratteristici e confortevoli braccioli strutturali.

Un telaio tubolare in metallo dal design assolutamente distintivo, previsto in varie finiture. Disponibili inoltre diverse versioni dello schienale: tradizionale, alto o basso, da tappezzare o trapezoidale da tappezzare, in rete o plastica a vista. Grazie alla vasta gamma di componenti, due tipi di braccioli a scelta e due opzioni di sedile, **Magix** è adattabile a un ampio numero di telai per un assortimento completo.

Plus:

- vasta gamma di componenti sia per lo schienale sia per il sedile;
- estremamente versatile e completa.

Magix è la soluzione ideale per **ambiente conference, meeting room** o per il **front office**.

The chair featuring distinctive and comfortable structural armrests.

A tubular metal frame with a highly distinctive design, available in a range of finishes. Different versions of the backrest are also available: traditional, high or low, to be upholstered or trapezoidal to be upholstered, in mesh or bare plastic. Thanks to the wide range of components, choice of two types of armrest and two seat options, **Magix** can be adapted to a large number of frames to provide an extensive range of options.

Advantages:

- wide range of components for both the backrest and the seat;
- extremely versatile and complete.

Magix is the ideal solution for **conference and meeting room environments** or for **front offices**.

magix

slide



CERTIFIED BY
CATAS

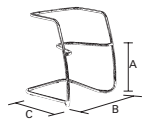
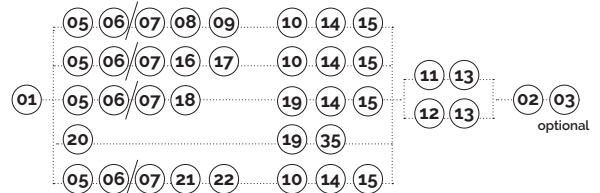
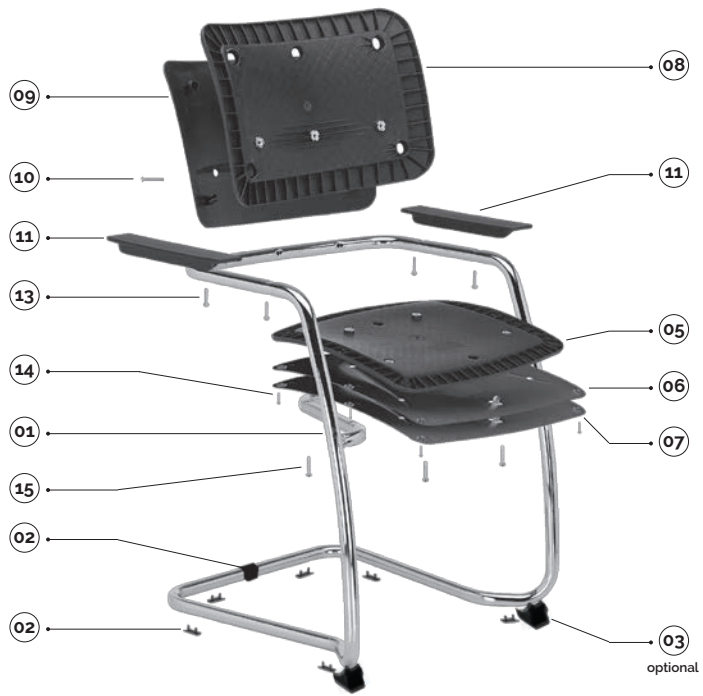

01

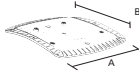

05



06



07

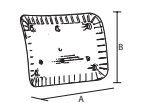

08

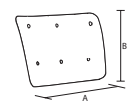

09

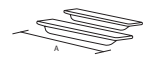

11



03



01 magix-base a slitta in tubo asform d.25 tappi esclusi
magix-slide frame pipe d.25 without caps

code	finishing	q.kit	q.pack	a	b	c	kg.x1	vol.x1
110503-009	● nero/black	x1	48	450	560	560	4,90	mc. 0,045
110504-112	● grigio/grey	x1	48	450	560	560	4,90	mc. 0,045
110510-095	● cromato/chrome	x1	48	450	560	560	4,90	mc. 0,045

02 magix-confezione accessori 50 picma + 290 p2pa
magix-pack of accessories 50 picma + 290 p2pa

code	finishing	q.kit	q.pack	kg.x1	vol.x1
137000-009	● nero/black	x1x6	50+290	1,00	mc. 0,1413

03 piedino antibaltamento in plastica nero + viti
plastic black feet anti-upsetting + screws

code	finishing	q.kit	q.pack	kg.x1	vol.x1
134303-006	● nero/black	x2	100	0,025	mc. 0,0001

05 magix sdi-sedile interno plastica nero
magix sdi-black plastic inner seat

code	finishing	q.kit	q.pack	a	b	kg.x1	vol.x1
132203-035	● nero/black	x1	10	480	460	1,10	mc. 0,045

06 magix sde-sedile esterno plastica nero
magix sde-black plastic external seat

code	finishing	q.kit	q.pack	a	b	kg.x1	vol.x1
132203-036	● nero/black	x1	20	450	420	0,34	mc. 0,051

07 magix sde-sedile esterno plastica nero per slitta
magix sde-black plastic external seat for slide frame

code	finishing	q.kit	q.pack	a	b	kg.x1	vol.x1
132203-037	● nero/black	x1	20	450	420	0,436	mc. 0,051

08 magix shi-schienale interno plastica nero
magix shi-black plastic inner back

code	finishing	q.kit	q.pack	a	b	kg.x1	vol.x1
132103-040	● nero/black	x1	20	470	290	0,95	mc. 0,004

09 magix she-schienale esterno plastica nero
magix she-black plastic external back

code	finishing	q.kit	q.pack	a	b	kg.x1	vol.x1
132103-041	● nero/black	x1	20	470	290	0,26	mc. 0,055

11 bracciolo destro e sinistro plastica nero
left right black plastic arm

code	finishing	q.kit	q.pack	a	kg.x1	vol.x1
131703-040	● nero/black	x2	100	200	0,04	mc. 0,0004

13 confezioni viti trucioliari tsp+ d.4x25 zincate (per fissare braccioli)
shaving screws tsp+ d.4x25 zinc package (for arms)

code	finishing	q.kit	q.pack
117011-072	○ zincata/zinc	x4	200

14 confezione viti tbl+ fr. d.5x14 brunita nera
screws tbl+ fr.hilo d.5x14 burnished black package

code	finishing	q.kit	q.pack
117003-071	● nero/black	x6	200

15 vite tsp+m6x35 zincata per il sedile
screw tsp+m6x35 zinc for the seat

code	finishing	q.kit
117711-183	○ zincata/zinc	x4

10 vite tspcei m6x40
screw tspcei m6x40

code	finishing	q.kit
117711-250	○ zincata/zinc	x3

main component sizes

optipnals

magix

slide/armrest option

main component sizes

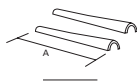

12



12 bracciolo destro e sinistro plastica conico
left right black plastic conic arm

code	finishing	q.kit	q.pack	a	kg.x1	vol.x1
131703-041	● nero/black	x2	200	205	0,04	mc. 0.0002

slide/backrest and seat options

main component sizes

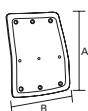

16



16 magix shi-schienale interno alto plastica nero
magix shi-inside black plastic inner back

code	finishing	q.kit	q.pack	a	b	kg.x1	vol.x1
132103-043	● nero/black	x1	20	540	450	1,80	mc. 0.0055

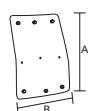

17

17 magix she-schienale alto esterno plastica nero
magix she-black plastic external high back

code	finishing	q.kit	q.pack	a	b	kg.x1	vol.x1
132103-042	● nero/black	x1	20	540	450	0,50	mc. 0.0069

and · **10** **14** **15** **13**

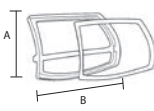

18



18 schienale e cornice per rete urban
outer back and open frame for urban net

code	finishing	q.kit	q.pack	a	b	kg.x1	vol.x1
132103-037	● nero/black	x1	10	288	453	0,98	mc. 0.015

19 vite tspcei m6x35
screw tspcei m6x35

code	finishing	q.kit
117711-180	○ zincata/zinc	x3

and · **14** **15** **13**

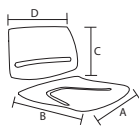

20



20 sedile e schienale a vista urban
seat and back sight urban

code	finishing	q.kit	q.pack	a	b	c	d	kg.x1	vol.x1
134003-112	● nero/black	x1	10	452	425	288	453	2,5	mc. 0.016
134004-112	● grigio/grey	x1	10	452	425	288	453	2,5	mc. 0.016
134005-112	○ bianco/white	x1	10	452	425	288	453	2,5	mc. 0.016

19 vite tspcei m6x35
screw tspcei m6x35

code	finishing	q.kit
117711-180	○ zincata/zinc	x3

35 vite autoflettante ts* 5,5x38 zincata
screw autothreading ts* 5,5x38 flared cross

code	finishing	q.kit
117811-165	○ zincata/zinc	x4

and · **13**

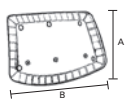

21



21 schienale interno urban
inner back urban

code	finishing	q.kit	q.pack	a	b	kg.x1	vol.x1
132103-039	● nero/black	x1	20	450	540	0,77	mc. 0.006

22 schienale esterno urban
outer back urban

code	finishing	q.kit	q.pack	a	b	kg.x1	vol.x1
132103-038	● nero/black	x1	20	450	540	0,24	mc. 0.006

and · **10** **14** **15** **13**

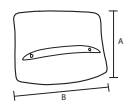

22

magix

4-legs

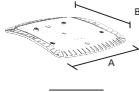
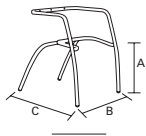
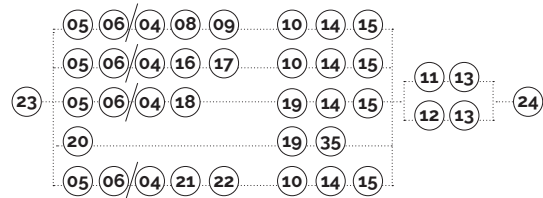
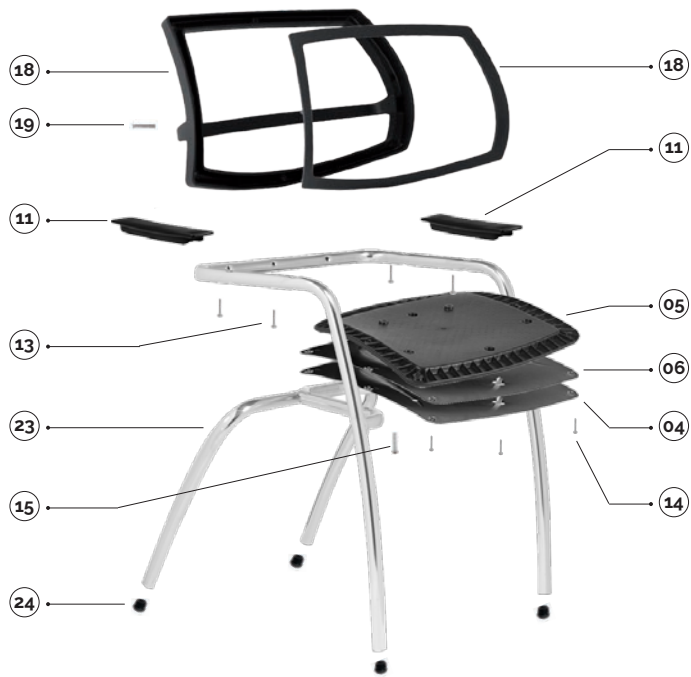

23

05



06

04

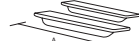

18

11

main component sizes

23 magix-telaio quattro gambe d.25 senza tappi
magix-four legs frame d.25 without caps

code	finishing	q.kit	q.pack	a	b	c	kg.x1	vol.x1
110103-006	● nero/black	x1	30	450	550	550	4.10	mc. 0.045
110104-006	● grigio/grey	x1	30	450	550	550	4.10	mc. 0.045
110110-006	● cromato/chrome	x1	30	450	550	550	4.10	mc. 0.045

24 confezione puntali a testa sferica d.25
cap d.25 spherical head black package

code	finishing	q.kit	q.pack
137003-075	● nero/black	x4	120

05 magix sdi-sedile interno plastica nero
magix sdi-black plastic inner seat

code	finishing	q.kit	q.pack	a	b	kg.x1	vol.x1
132203-035	● nero/black	x1	10	480	460	1.10	mc. 0.045

06 magix sde-sedile esterno plastica nero
magix sde-black plastic external seat

code	finishing	q.kit	q.pack	a	b	kg.x1	vol.x1
132203-036	● nero/black	x1	20	450	420	0.34	mc. 0.051

04 magix sde-sedile esterno plastica nero per telaio 4 gambe
magix sde-black plastic external seat for 4-legs frame

code	finishing	q.kit	q.pack	a	b	kg.x1	vol.x1
132203-038	● nero/black	x1	20	450	420	0.452	mc. 0.051

18 schienale e cornice per rete urban
outer back and open frame for urban net

code	finishing	q.kit	q.pack	a	b	kg.x1	vol.x1
132103-037	● nero/black	x1	10	288	453	0.98	mc. 0.015

11 bracciolo destro e sinistro plastica nero
left right black plastic arm

code	finishing	q.kit	q.pack	a	kg.x1	vol.x1
131703-040	● nero/black	x2	100	200	0.04	mc. 0.0004

13 confezioni viti trucioliari tsp+ d.4x25 zincate (per fissare braccioli)
shaving screws tsp+ d.4x25 zinc package (for arms)

code	finishing	q.kit	q.pack
117011-072	○ zincata/zinc	x4	200

14 confezione viti tbl+ fr. d.5x14 brunita nera
screws tbl+ fr.hilo d.5x14 burnished black package

code	finishing	q.kit	q.pack
117003-071	● nero/black	x6	200

15 vite tsp+m6x35 zincata per il sedile
screw tsp+m6x35 zinc for the seat

code	finishing	q.kit
117711-183	○ zincata/zinc	x4

19 vite tspcei m6x35
screw tspcei m6x35

code	finishing	q.kit
117711-180	○ zincata/zinc	x3

magix

4-legs/armrest option

main component sizes

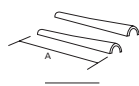

12



12 bracciolo destro e sinistro plastica conico
left right black plastic conic arm

code	finishing	q.kit	q.pack	a	kg.x1	vol.x1
131703-041	● nero/black	x2	200	205	0,04	mc. 0.0002

4-legs/backrest and seat options

main component sizes

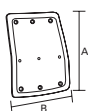

16



16 magix shi-schienale interno alto plastica nero
magix shi-inside black plastic inner back

code	finishing	q.kit	q.pack	a	b	kg.x1	vol.x1
132103-043	● nero/black	x1	20	540	450	1,80	mc. 0.0055

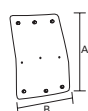

17

17 magix she-schienale alto esterno plastica nero
magix she-black plastic external high back

code	finishing	q.kit	q.pack	a	b	kg.x1	vol.x1
132103-042	● nero/black	x1	20	540	450	0,50	mc. 0.0069

and · **10** **14** **15** **13**

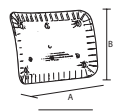

08



08 magix shi-schienale interno plastica nero
magix shi-black plastic inner back

code	finishing	q.kit	q.pack	a	b	kg.x1	vol.x1
132103-040	● nero/black	x1	20	470	290	0,95	mc. 0.004

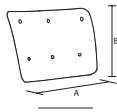

09

09 magix she-schienale esterno plastica nero
magix she-black plastic external back

code	finishing	q.kit	q.pack	a	b	kg.x1	vol.x1
132103-041	● nero/black	x1	20	470	290	0,26	mc. 0.055

and · **10** **14** **15** **13**

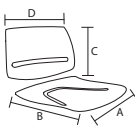

20



20 sedile e schienale a vista urban
seat and back sight urban

code	finishing	q.kit	q.pack	a	b	c	d	kg.x1	vol.x1
134003-112	● nero/black	x1	10	452	425	288	453	2,5	mc. 0.016
134004-112	● grigio/grey	x1	10	452	425	288	453	2,5	mc. 0.016
134005-112	○ bianco/white	x1	10	452	425	288	453	2,5	mc. 0.016

and · **19** **35** **13**

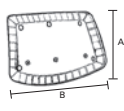

21



21 schienale interno urban
inner back urban

code	finishing	q.kit	q.pack	a	b	kg.x1	vol.x1
132103-039	● nero/black	x1	20	450	540	0,77	mc. 0.006

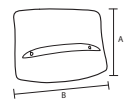

22

22 schienale esterno urban
outer back urban

code	finishing	q.kit	q.pack	a	b	kg.x1	vol.x1
132103-038	● nero/black	x1	20	450	540	0,24	mc. 0.006

and · **10** **14** **15** **13**

magix

4-legs for castors

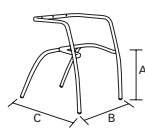
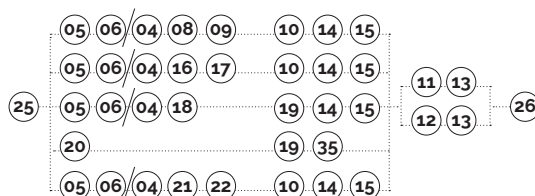
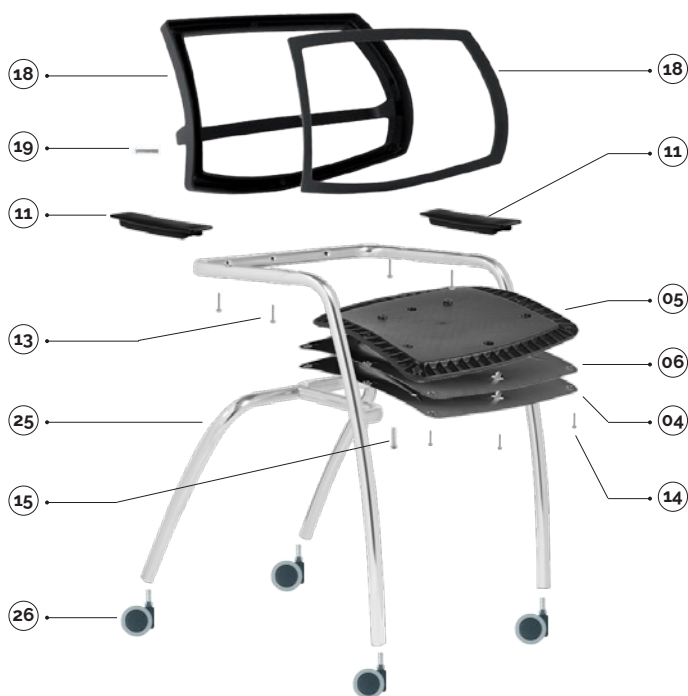

25

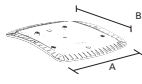

05

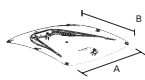

06



04

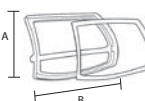

18

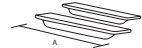

11

main component sizes

25 magix-telaio quattro gambe d.25 con riduttori per ruote magix-four legs frame d.25 with adapter for castor

code	finishing	q.kit	q.pack	a	b	c	kg.x1	vol.x1
110103-005	● nero/black	x1	30	450	550	550	3,90	mc. 0,045
110104-005	● grigio/grey	x1	30	450	550	550	3,90	mc. 0,045
110110-005	● cromato/chrome	x1	30	450	550	550	3,90	mc. 0,045

26 doppia ruota d.50 in desmopan con perno montato twin wheel castor d.50 desmopan with pivot mounted

code	finishing	q.kit
134403-003	● nero/black	x4

05 magix sdi-sedile interno plastica nero magix sdi-black plastic inner seat

code	finishing	q.kit	q.pack	a	b	kg.x1	vol.x1
132203-035	● nero/black	x1	10	480	460	1,10	mc. 0,045

06 magix sde-sedile esterno plastica nero magix sde-black plastic external seat

code	finishing	q.kit	q.pack	a	b	kg.x1	vol.x1
132203-036	● nero/black	x1	20	450	420	0,34	mc. 0,051

04 magix sde-sedile esterno plastica nero per telaio 4 gambe magix sde-black plastic external seat for 4-legs frame

code	finishing	q.kit	q.pack	a	b	kg.x1	vol.x1
132203-038	● nero/black	x1	20	450	420	0,452	mc. 0,051

18 schienale e cornice per rete urban outer back and open frame for urban net

code	finishing	q.kit	q.pack	a	b	kg.x1	vol.x1
132103-037	● nero/black	x1	10	288	453	0,98	mc. 0,015

11 bracciolo destro e sinistro plastica nero left right black plastic arm

code	finishing	q.kit	q.pack	a	kg.x1	vol.x1
131703-040	● nero/black	x2	100	200	0,04	mc. 0,0004

13 confezioni viti trucioliari tsp+ d.4x25 zincate (per fissare braccioli) shaving screws tsp+ d.4x25 zinc package (for arms)

code	finishing	q.kit	q.pack
117011-072	○ zincata/zinc	x4	200

14 confezione viti tbl+ fr. d.5x14 brunita nera screws tbl+ fr.hilo d.5x14 burnished black package

code	finishing	q.kit	q.pack
117003-071	● nero/black	x6	200

15 vite tsp+m6x35 zincata per il sedile screw tsp+m6x35 zinc for the seat

code	finishing	q.kit
117711-183	○ zincata/zinc	x4

19 vite tspcei m6x35 screw tspcei m6x35

code	finishing	q.kit
117711-180	○ zincata/zinc	x3

magix

4-legs for castors/armrest option

main component sizes

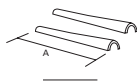

12



12 bracciolo destro e sinistro plastica conico
left right black plastic conic arm

code	finishing	q.kit	q.pack	a	kg.x1	vol.x1
131703-041	● nero/black	x2	200	205	0,04	mc. 0.0002

4-legs for castors/backrest and seat options

main component sizes

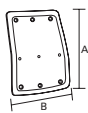

16



16 magix shi-schienale interno alto plastica nero
magix shi-inside black plastic inner back

code	finishing	q.kit	q.pack	a	b	kg.x1	vol.x1
132103-043	● nero/black	x1	20	540	450	1,80	mc. 0.0055

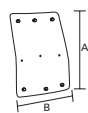

17

17 magix she-schienale alto esterno plastica nero
magix she-black plastic external high back

code	finishing	q.kit	q.pack	a	b	kg.x1	vol.x1
132103-042	● nero/black	x1	20	540	450	0,50	mc. 0.0069

and · 10 14 15 13

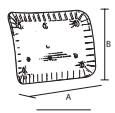

08



08 magix shi-schienale interno plastica nero
magix shi-black plastic inner back

code	finishing	q.kit	q.pack	a	b	kg.x1	vol.x1
132103-040	● nero/black	x1	20	470	290	0,95	mc. 0.004

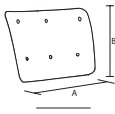

09

09 magix she-schienale esterno plastica nero
magix she-black plastic external back

code	finishing	q.kit	q.pack	a	b	kg.x1	vol.x1
132103-041	● nero/black	x1	20	470	290	0,26	mc. 0.055

and · 10 14 15 13



20



20 sedile e schienale a vista urban
seat and back sight urban

code	finishing	q.kit	q.pack	a	b	c	d	kg.x1	vol.x1
134003-112	● nero/black	x1	10	452	425	288	453	2,5	mc. 0.016
134004-112	● grigio/grey	x1	10	452	425	288	453	2,5	mc. 0.016
134005-112	○ bianco/white	x1	10	452	425	288	453	2,5	mc. 0.016

and · 19 35 13

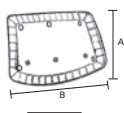

21



21 schienale interno urban
inner back urban

code	finishing	q.kit	q.pack	a	b	kg.x1	vol.x1
132103-039	● nero/black	x1	20	450	540	0,77	mc. 0.006

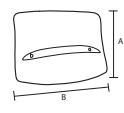

22

22 schienale esterno urban
outer back urban

code	finishing	q.kit	q.pack	a	b	kg.x1	vol.x1
132103-038	● nero/black	x1	20	450	540	0,24	mc. 0.006

and · 10 14 15 13

magix

swivel

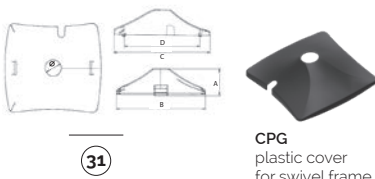
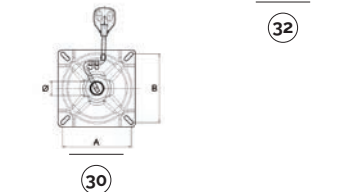
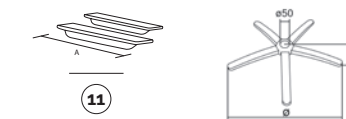
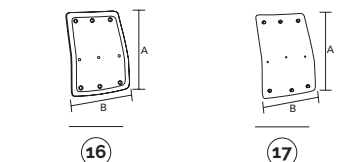
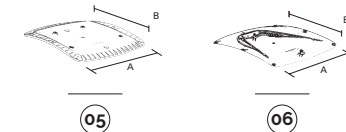
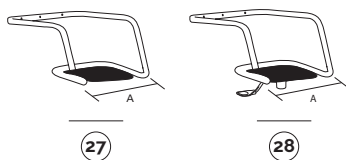
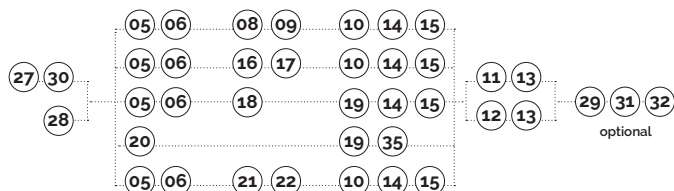

CPG
plastic cover
for swivel frame

main component sizes

optionals

27 magix-telaio girevole d.25 con braccioli senza tappi
magix-d.25 swivelmetal frame arms without caps

code	finishing	q.kit	q.pack	a	kg.x1	vol.x1
110910-034	● cromato/chrome	x1	50	550	5,00	mc. 0.045

28 magix(01)gc-telaio girevole d.25 con braccioli senza tappi + spatola
magix(01)gc-d.25 swivelmetal frame arms without caps with gas plate welded

code	finishing	q.kit	q.pack	a	kg.x1	vol.x1
110910-033	● cromato/chrome	x1	50	550	5,00	mc. 0.045

05 magix sdi-sedile interno plastica nero
magix sdi-black plastic inner seat

code	finishing	q.kit	q.pack	a	b	kg.x1	vol.x1
132203-035	● nero/black	x1	10	480	460	1,10	mc. 0.045

06 magix sde-sedile esterno plastica nero
magix sde-black plastic external seat

code	finishing	q.kit	q.pack	a	b	kg.x1	vol.x1
132203-036	● nero/black	x1	20	450	420	0,34	mc. 0.051

16 magix shi-schienale interno alto plastica nero
magix shi-inside black plastic inner back

code	finishing	q.kit	q.pack	a	b	kg.x1	vol.x1
132103-043	● nero/black	x1	20	540	450	1,80	mc. 0.0055

17 magix she-schienale alto esterno plastica nero
magix she-black plastic external high back

code	finishing	q.kit	q.pack	a	b	kg.x1	vol.x1
132103-042	● nero/black	x1	20	540	450	0,50	mc. 0.0069

10 vite tspcei m6x40
screw tspcei m6x40

code	finishing	q.kit	q.pack	a	kg.x1	vol.x1
117711-250	○ zincata/zinc	x3				

11 bracciolo destro e sinistro plastica nero
left right black plastic arm

code	finishing	q.kit	q.pack	a	kg.x1	vol.x1
131703-040	● nero/black	x2	100	200	0,04	mc. 0.0004

13 confezioni viti trucciolari tsp+ d.4x25 zincate (per fissare braccioli)
shaving screws tsp+ d.4x25 zinc package (for arms)

code	finishing	q.kit	q.pack	a	kg.x1	vol.x1
117011-072	○ zincata/zinc	x4	200			

30 pss28nr-piastra sgabello c/spat. c/28 3' l4 nera
pss28nr- square metal plate with straight lever c/28 3' l4

code	finishing	q.kit	q.pack	a	b	ø	kg.x1	vol.x1
113003-104	● nero/black	x1	25	150	150	28	1,23	mc. 0.002

31 cpg-copertina in plastica per telaio girevole
cpg-plastic cover for swivel frame

code	finishing	q.kit	q.pack	a	b	c	d	ø	kg.x1	vol.x1
130903-000	● nero/black	x1	50	60	200	210	167	36	0,1	mc. 0.0015

32 b40 base in metallo d.640 con coprisaldatura
b40 metal base d.640 with cover welding

code	finishing	q.kit	q.pack	a	ø	kg.x1	vol.x1
110210-027	● cromato/chrome	x1	5	60	640	2,85	mc. 0.014

14 confezione viti tbl+ fr. d.5x14 brunita nera
screws tbl+ fr.hilo d.5x14 burnished black package

code	finishing	q.kit	q.pack	a	kg.x1	vol.x1
117003-071	● nero/black	x6	200			

29 tappo copritesta alettato d.25 nero
cover head d.25 black

code	finishing	q.kit
134103-250	● nero/black	x2

15 vite tsp+m6x35 zincata per il sedile
screw tsp+m6x35 zinc for the seat

code	finishing	q.kit
117711-183	○ zincata/zinc	x4

magix

swivel/armrest option

main component sizes

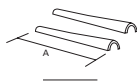

12



12 bracciolo destro e sinistro plastica conico
left right black plastic conic arm

code	finishing	q.kit	q.pack	a	kg.x1	vol.x1
131703-041	● nero/black	x2	200	205	0,04	mc. 0.0002

swivel/backrest and seat options

main component sizes

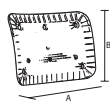

08



08 magix shi-schienale interno plastica nero
magix shi-black plastic inner back

code	finishing	q.kit	q.pack	a	b	kg.x1	vol.x1
132103-040	● nero/black	x1	20	470	290	0,95	mc. 0.004

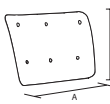

09

09 magix she-schienale esterno plastica nero
magix she-black plastic external back

code	finishing	q.kit	q.pack	a	b	kg.x1	vol.x1
132103-041	● nero/black	x1	20	470	290	0,26	mc. 0.055

and - **10** **14** **15** **13**

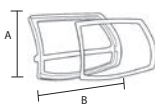

18



18 schienale e cornice per rete urban
outer back and open frame for urban net

code	finishing	q.kit	q.pack	a	b	kg.x1	vol.x1
132103-037	● nero/black	x1	10	288	453	0,98	mc. 0.015

19 vite tspcei m6x35
screw tspcei m6x35

code	finishing	q.kit
117711-180	○ zincata/zinc	x3

and - **14** **15** **13**

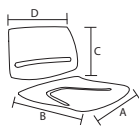

20



20 sedile e schienale a vista urban
seat and back sight urban

code	finishing	q.kit	q.pack	a	b	c	d	kg.x1	vol.x1
134003-112	● nero/black	x1	10	452	425	288	453	2,5	mc. 0.016
134004-112	● grigio/grey	x1	10	452	425	288	453	2,5	mc. 0.016
134005-112	○ bianco/white	x1	10	452	425	288	453	2,5	mc. 0.016

19 vite tspcei m6x35
screw tspcei m6x35

code	finishing	q.kit
117711-180	○ zincata/zinc	x3

and - **35** **13**

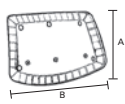

21



21 schienale interno urban
inner back urban

code	finishing	q.kit	q.pack	a	b	kg.x1	vol.x1
132103-039	● nero/black	x1	20	450	540	0,77	mc. 0.006

22 schienale esterno urban
outer back urban

code	finishing	q.kit	q.pack	a	b	kg.x1	vol.x1
132103-038	● nero/black	x1	20	450	540	0,24	mc. 0.006

and - **10** **14** **15** **13**

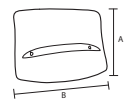

22

magix

bench

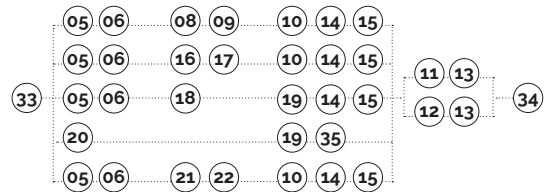

33 magix-telaio panca d.25 con braccioli senza tappi

magix-d.25 bench metal frame arms without caps

code	finishing	q.kit	q.pack	a	kg.x1	vol.x1
110710-200	● cromato/chrome	x1	60	550	5,00	mc. 0,045

20 sedile e schienale a vista urban

seat and back sight urban

code	finishing	q.kit	q.pack	a	b	c	d	kg.x1	vol.x1
134003-112	● nero/black	x1	10	452	425	288	453	2,5	mc. 0,016
134004-112	● grigio/grey	x1	10	452	425	288	453	2,5	mc. 0,016
134005-112	○ bianco/white	x1	10	452	425	288	453	2,5	mc. 0,016

19 vite tspcei m6x35

screw tspcei m6x35

code	finishing	q.kit
117711-180	○ zincata/zinc	x3

12 bracciolo destro e sinistro plastica conico

left right black plastic conic arm

code	finishing	q.kit	q.pack	a	kg.x1	vol.x1
131703-041	● nero/black	x2	200	205	0,04	mc. 0,0002

13 confezioni viti truciolari tsp+ d.4x25 zincate (per fissare braccioli)

shaving screws tsp+ d.4x25 zinc package (for arms)

code	finishing	q.kit	q.pack
117011-072	○ zincata/zinc	x4	200

35 vite autoflettante ts+ 5,5x38 zincata

screw autofthreading ts+ 5,5x38 flared cross

code	finishing	q.kit
117811-165	○ zincata/zinc	x4

29 tappo copritesta alettato d.25 nero

cover head d.25 black

code	finishing	q.kit
134103-250	● nero/black	x2

34 got(03) trave per panca 80x40

got(03) beam for bench 80x40

code	finishing	posti	q.kit	q.pack	a	b	c	kg.x1	vol.x1
110703-190	● nero/black	2 posti/2 seats	x1	1	1160	80	40	3,20	mc. 0,0045
110704-190	● grigio/grey	2 posti/2 seats	x1	1	1160	80	40	3,20	mc. 0,0045
110703-191	● nero/black	3 posti/3 seats	x1	1	1710	80	40	4,71	mc. 0,0005
110704-191	● grigio/grey	3 posti/3 seats	x1	1	1710	80	40	4,71	mc. 0,0005
110703-192	● nero/black	4 posti/4 seats	x1	1	2260	80	40	6,22	mc. 0,0085
110704-192	● grigio/grey	4 posti/4 seats	x1	1	2260	80	40	6,22	mc. 0,0085
110703-193	● nero/black	5 posti/5 seats	x1	1	2800	80	40	7,72	mc. 0,01
110704-197	● grigio/grey	5 posti/5 seats	x1	1	2800	80	40	7,72	mc. 0,01

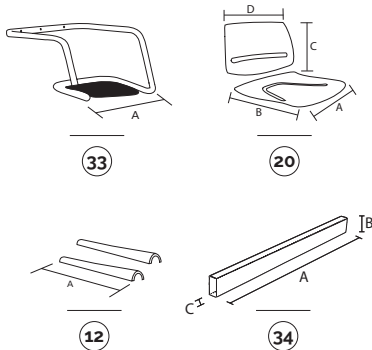

main component sizes

for the bench components, see page 249

OPTIONAL
bench
connector

E-USB **NEW**
bench plug

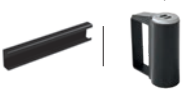

JIM **NEW**
bench leg

APOLL
bench arm



plastic

90GM
bench leg

90GF
bench leg

100GM
bench leg

200GM
bench leg

PIONEER
bench arm



metal

CUT
bench leg

SLIM
bench leg

CUT
bench arm

SLIM
bench arm



aluminium

optionals

magix

bench/armrest option

main component sizes

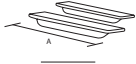

11

11 bracciolo destro e sinistro plastica nero left right black plastic arm

code	finishing	q.kit	q.pack	a	kg.x1	vol.x1
131703-040	● nero/black	x2	100	200	0,04	mc. 0.0004

bench/backrest and seat options

main component sizes

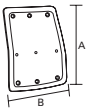

16



16 magix shi-schienale interno alto plastica nero magix shi-inside black plastic inner back

code	finishing	q.kit	q.pack	a	b	kg.x1	vol.x1
132103-043	● nero/black	x1	20	540	450	1,80	mc. 0.0055

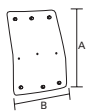

17



17 magix she-schienale alto esterno plastica nero magix she-black plastic external high back

code	finishing	q.kit	q.pack	a	b	kg.x1	vol.x1
132103-042	● nero/black	x1	20	540	450	0,50	mc. 0.0069

and · 10 14 15 13

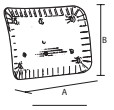

08



08 magix shi-schienale interno plastica nero magix shi-black plastic inner back

code	finishing	q.kit	q.pack	a	b	kg.x1	vol.x1
132103-040	● nero/black	x1	20	470	290	0,95	mc. 0.004

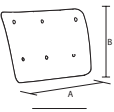

09



09 magix she-schienale esterno plastica nero magix she-black plastic external back

code	finishing	q.kit	q.pack	a	b	kg.x1	vol.x1
132103-041	● nero/black	x1	20	470	290	0,26	mc. 0.055

and · 10 14 15 13

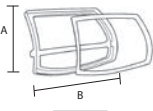

18



18 schienale e cornice per rete urban outer back and open frame for urban net

code	finishing	q.kit	q.pack	a	b	kg.x1	vol.x1
132103-037	● nero/black	x1	10	288	453	0,98	mc. 0.015

and · 19 14 15 13

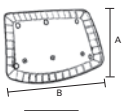

21



21 schienale interno urban inner back urban

code	finishing	q.kit	q.pack	a	b	kg.x1	vol.x1
132103-039	● nero/black	x1	20	450	540	0,77	mc. 0.006

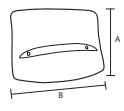

22



22 schienale esterno urban outer back urban

code	finishing	q.kit	q.pack	a	b	kg.x1	vol.x1
132103-038	● nero/black	x1	20	450	540	0,24	mc. 0.006

and · 10 14 15 13



BEYOND **Design**





starlight



starlight



side

4 legs

swivel



EN 16139

tools



configurator



brochure



certification



video

starlight showing

features



designed by:
angelo pinaffo



La sedia di design firmata da una matita prestigiosa.

Solida, confortevole e robusta ma dal design leggero ed elegante; è in grado di regalare luce all'ambiente con il suo elegante schienale in rete. Disponibile anche con pannello da tappezzare.

Plus:

- design distintivo;
- sedia solida e robusta;
- disponibile nei telai a slitta, 4 gambe e girevole;
- poggiatesta integrato allo schienale.

Starlight è pensata per l'ambiente **Office e Meeting room**.

Exclusive chair crafted by a renowned designer.

Solid, comfortable and durable but with a light and elegant design; the elegant mesh backrest is guaranteed to brighten up any environment. Also available with seat pad to be upholstered.

Advantages:

- distinctive design;
- solid and robust chair;
- available in sled, 4-legged and swivel frames;
- lumbar support integrated into the backrest.

Starlight is designed for **Office and Meeting room environments**.

starlight

slide



CERTIFIED BY
CATAS

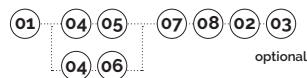
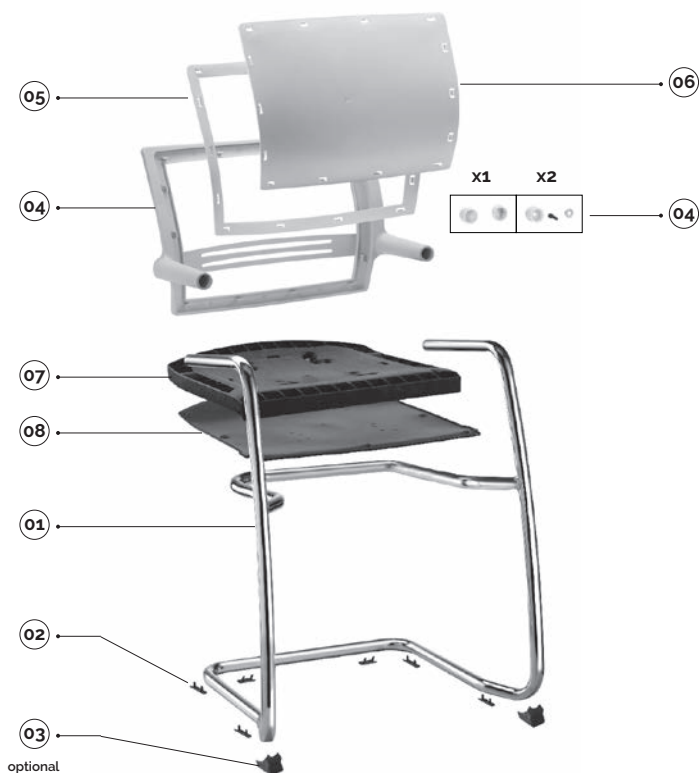

main component sizes

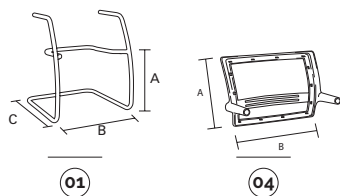

01

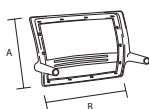

04

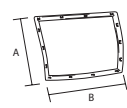

05

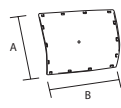

06

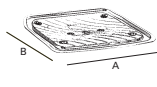

07



08



03

**piedino antiribaltamento
in plastica**
plastic black feet
anti-upsetting



optionals

01 starlight-base a slitta in tubo asform d.25 tappi esclusi starlight-slide frame pipe d.25 without caps

code	finishing	q.kit	q.pack	a	b	c	kg.x1	vol.x1
110503-120	● nero/black	x1	36	450	560	550	4,80	mc. 0.045
110504-120	● grigio/grey ikea 4	x1	36	450	560	550	4,80	mc. 0.045
110505-120	● avorio/ivory ral 1013	x1	36	450	560	550	4,80	mc. 0.045
110510-120	● cromato/chrome	x1	36	450	560	550	4,80	mc. 0.045

02 p2p-pinza due pioli in polietilene nera p2p-two pins pliers in black polythene

code	finishing	q.kit
134003-003	● nero/black	x6

03 piedino antiribaltamento in plastica plastic black feet anti-upsetting

code	finishing	q.kit	q.pack
134303-006	● nero/black	x2	100

04 starlight-schienale esterno + tappi + accessori starlight-back frame in plastic+ caps + accessories

code	finishing	q.kit	q.pack	a	b	kg.x1	vol.x1
132103-055	● nero/black	x1	10	360	510	1,60	mc. 0.017
132105-055	○ bianco/white	x1	10	360	510	1,60	mc. 0.017

05 starlight-cornice aperta schienale per rete starlight-open frame in plastic for mesh

code	finishing	q.kit	q.pack	a	b	kg.x1	vol.x1
132103-049	● nero/black	x1	10	340	460	0,36	mc. 0.0057
132105-049	○ bianco/white	x1	10	340	460	0,36	mc. 0.0057

06 starlight-pannello schienale in plastica da tappezzare starlight-plastic panel back for upholstery

code	finishing	q.kit	q.pack	a	b	kg.x1	vol.x1
132103-048	● nero/black	x1	10	340	460	0,50	mc. 0.004
132105-048	○ bianco/white	x1	10	340	460	0,50	mc. 0.004

07 starlight-sedile interno da tappezzare per slitta starlight-inner seat to be upholstered for slide frame

code	finishing	q.kit	q.pack	a	b	kg.x1	vol.x1
132203-061	● nero/black	x1	10	490	470	1,90	mc. 0.011

08 starlight-sottosedile esterno + n'8 viti starlight-sottosedile esterno + n'8 viti

code	finishing	q.kit	q.pack	a	b	kg.x1	vol.x1
132203-064	● nero/black	x1	20	470	440	0,57	mc. 0.0025

starlight

4-legs

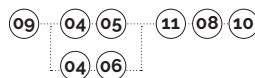
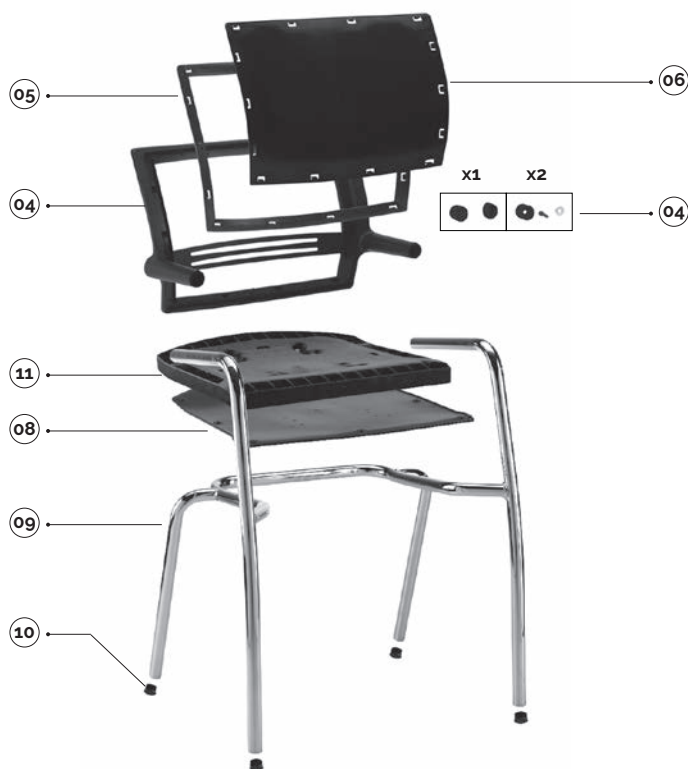

main component sizes

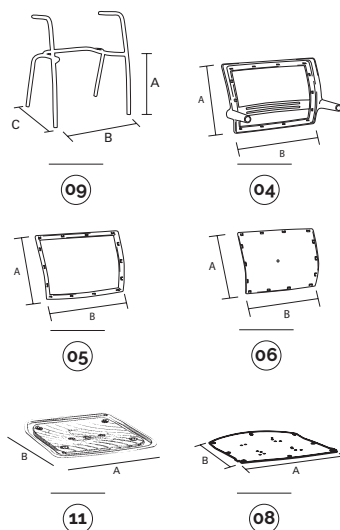

09 starlight-telaio 4 gambe d.25 tappi esclusi

starlight-4-legs frame d.25 without caps

code	finishing	q.kit	q.pack	a	b	c	kg.x1	vol.x1
112603-060	● nero/black	x1	30	450	560	550	3,60	mc. 0.045
112604-060	● grigio/grey ikea 4	x1	30	450	560	550	3,60	mc. 0.045
112605-060	● avorio/ivory ral 1013	x1	30	450	560	550	3,60	mc. 0.045
112610-060	● cromato/chrome	x1	30	450	560	550	3,60	mc. 0.045

10 confezione puntali a testa sferica d.25

cap d.25 spherical head black package

code	finishing	q.kit	q.pack
137003-075	● nero/black	x4	120

04 starlight-schienale esterno + tappi + accessori

starlight-back frame in plastic+ caps + accessories

code	finishing	q.kit	q.pack	a	b	kg.x1	vol.x1
132103-055	● nero/black	x1	10	360	510	1,60	mc. 0.017
132105-055	○ bianco/white	x1	10	360	510	1,60	mc. 0.017

05 starlight-cornice aperta schienale per rete

starlight-open frame in plastic for mesh

code	finishing	q.kit	q.pack	a	b	kg.x1	vol.x1
132103-049	● nero/black	x1	10	340	460	0,36	mc. 0.0057
132105-049	○ bianco/white	x1	10	340	460	0,36	mc. 0.0057

06 starlight-pannello schienale in plastica da tappezzare

starlight-plastic panel back for upholstery

code	finishing	q.kit	q.pack	a	b	kg.x1	vol.x1
132103-048	● nero/black	x1	10	340	460	0,50	mc. 0.004
132105-048	○ bianco/white	x1	10	340	460	0,50	mc. 0.004

11 starlight-sedile interno da tappezzare per 4 gambe

starlight-inner seat to be upholstered for 4-legs frame

code	finishing	q.kit	q.pack	a	b	kg.x1	vol.x1
132203-063	● nero/black	x1	10	490	470	1,90	mc. 0.011

08 starlight-sottosedile esterno + n'8 viti

starlight-sottosedile esterno + n'8 viti

code	finishing	q.kit	q.pack	a	b	kg.x1	vol.x1
132203-064	● nero/black	x1	20	470	440	0,57	mc. 0.0025

starlight

swivel

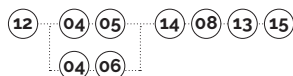

main component sizes

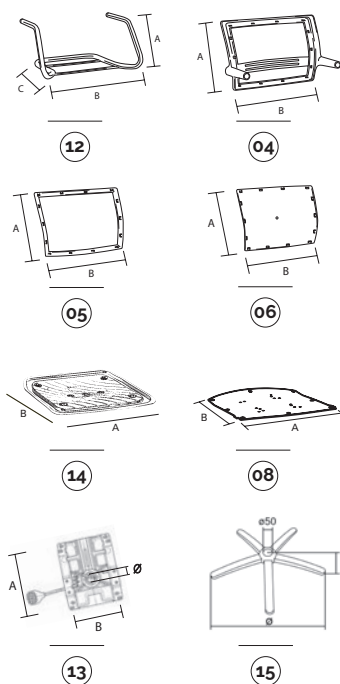

12 starlight-telaio girevole starlight-swivel frame

code	finishing	q.kit	q.pack	a	b	c	kg.x1	vol.x1
110903-075	● nero/black	x1	80	270	575	395	3.10	mc. 0.04
110904-075	● grigio/grey ikea 4	x1	80	270	575	395	3.10	mc. 0.04
110905-070	● avorio/ivory ral 1013	x1	80	270	575	395	3.10	mc. 0.04
110910-070	● cromato/chrome	x1	80	270	575	395	3.10	mc. 0.04

13 piastra a gas dattilo cono 28 con leva seat place cone 28 with lever

code	finishing	q.kit	q.pack	a	b	Ø	kg.x1	vol.x1
113003-121	● nero/black	x1	20	200	153	28	1.23	mc. 0.002

04 starlight-schienale esterno + tappi + accessori starlight-back frame in plastic+ caps + accessories

code	finishing	q.kit	q.pack	a	b	kg.x1	vol.x1
132103-055	● nero/black	x1	10	360	510	1.60	mc. 0.017
132105-055	○ bianco/white	x1	10	360	510	1.60	mc. 0.017

05 starlight-cornice aperta schienale per rete starlight-open frame in plastic for mesh

code	finishing	q.kit	q.pack	a	b	kg.x1	vol.x1
132103-049	● nero/black	x1	10	340	460	0.36	mc. 0.0057
132105-049	○ bianco/white	x1	10	340	460	0.36	mc. 0.0057

06 starlight-pannello schienale in plastica da tappezzare starlight-plastic panel back for upholstery

code	finishing	q.kit	q.pack	a	b	kg.x1	vol.x1
132103-048	● nero/black	x1	10	340	460	0.50	mc. 0.004
132105-048	○ bianco/white	x1	10	340	460	0.50	mc. 0.004

14 starlight-sedile interno da tappezzare per girevole con borchie starlight-inner seat to be upholstered for swivel with studs

code	finishing	q.kit	q.pack	a	b	kg.x1	vol.x1
132203-065	● nero/black	x1	10	490	470	1.90	mc. 0.011

08 starlight-sottosedile esterno + n'8 viti starlight-sottosedile esterno + n'8 viti

code	finishing	q.kit	q.pack	a	b	kg.x1	vol.x1
132203-064	● nero/black	x1	20	470	440	0.57	mc. 0.0025

15 b40 base in metallo d.640 con coprisaldatura b40 metal base d.640 with cover welding

code	finishing	q.kit	q.pack	a	Ø	kg.x1	vol.x1
110210-027	● cromato/chrome	x1	5	60	640	2.85	mc. 0.014



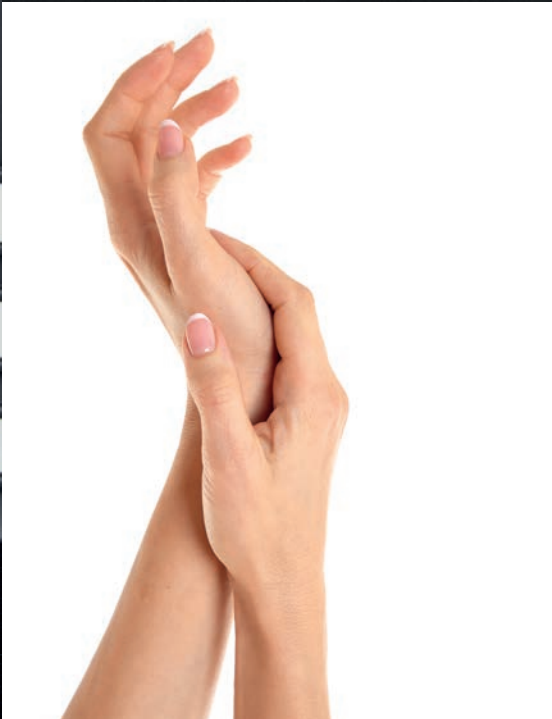



moon



moon



side

4 legs

swivel



EN 15373

EN 13761

moon showing

tools



certification

features



designed by:
r&d albacomponents



La seduta dallo schienale portante che le garantisce un design distintivo.

Massima stabilità e stile grazie allo schienale esterno portante in plastica, bianca o nera, che può essere a vista o con pannello aggiuntivo da tappezzare, e che costituisce un tutt'uno sia con la base slitta sia con il telaio 4 gambe.

Plus:

- design distintivo;
- estrema comodità;
- massima stabilità del telaio;
- qualità certificata CATAS;
- disponibile anche la girevole su base 4 razze.

Moon è ideale per il front office e le meeting room.

Chair with supportive backrest featuring an eye-catching design.

Superb stability and style thanks to the supportive backrest in white or black plastic, which can be visible or with an additional panel to be upholstered, and which forms a single piece with both the sled base and 4-legged frame.

Advantages:

- distinctive design;
- extreme comfort;
- maximum stability of the frame;
- CATAS certified quality;
- a 4-star swivel base version is also available.

Moon is ideal for front office and meeting rooms.

moon

slide



CERTIFIED BY
CATAS

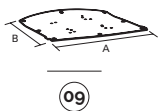
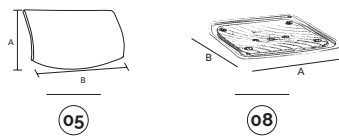
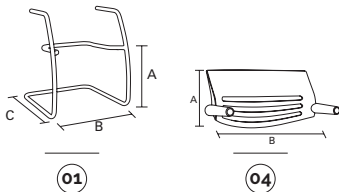
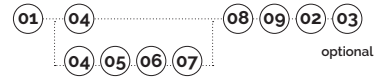

piedino antiribaltamento in plastica
plastic black feet anti-upsetting



01 moon-base a slitta in tubo asform d.25 tappi esclusi
moon-slide frame pipe d. 25 without caps

code	finishing	q.kit	q.pack	a	b	c	kg.x1	vol.x1
110503-120	● nero/black	x1	36	450	560	550	4,80	mc. 0,045
110504-120	● grigio/grey ikea 4	x1	36	450	560	550	4,80	mc. 0,045
110510-120	● cromato/chrome	x1	36	450	560	550	4,80	mc. 0,045

02 p2p-pinza due pioli in polietilene nera
p2p-two pins pliers in black polythene

code	finishing	q.kit
134003-003	● nero/black	x6

03 piedino antiribaltamento in plastica
plastic black feet anti-upsetting

code	finishing	q.kit	q.pack
134303-006	● nero/black	x2	100

04 moon-schienale esterno portante con accessori
moon-inside back carrier with accessories

code	finishing	q.kit	q.pack	a	b	kg.x1	vol.x1
132103-052	● nero/black	x1	12	270	510	1,60	mc. 0,017
132105-052	○ bianco/white	x1	12	270	510	1,60	mc. 0,017

05 moon-pannello schienale da tappezzare
moon-back panel for upholstery

code	finishing	q.kit	q.pack	a	b	kg.x1	vol.x1
132103-053	● nero/black	x1	20	300	400	0,29	mc. 0,003

06 vite hilo tlb+ 5x12 clipper zincata nera
screw hilo tlb+ 5x12 clipper zinc black

code	finishing	q.kit
117803-151	● nero/black	x6

07 coprivite clipper in plastica
screw cover clipper in plastic

code	finishing	q.kit
134403-200	● nero/black	x6
134405-200	○ bianco/white	x6

08 moon-sedile interno da tappezzare
moon-inside seat to be upholstered

code	finishing	q.kit	q.pack	a	b	kg.x1	vol.x1
132203-061	● nero/black	x1	10	490	470	1,90	mc. 0,011

09 moon-sottosedile esterno plastica nero + 8 viti
moon-external black plastic underseat + 8 screws

code	finishing	q.kit	q.pack	a	b	kg.x1	vol.x1
132203-064	● nero/black	x1	20	470	440	0,57	mc. 0,0025

main component sizes

optionals

moon

4-legs

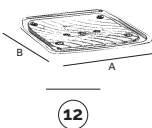
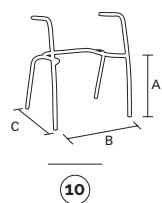
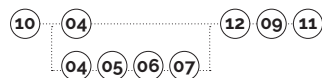

10 moon-telaio quattro gambe d.25 senza tappi
moon-four legs frame d.25 without caps

code	finishing	q.kit	q.pack	a	b	c	kg.x1	vol.x1
112603-060	● nero/black	x1	30	450	560	550	3,60	mc. 0.045
112604-060	● grigio/grey ikea 4	x1	30	450	560	550	3,60	mc. 0.045
112610-060	● cromato/chrome	x1	30	450	560	550	3,60	mc. 0.045

11 confezione puntali a testa sferica d.25
cap d.25 spherical head black package

code	finishing	q.kit	q.pack
137003-075	● nero/black	x4	120

12 moon-sedile interno da tappezzare per 4 gambe
moon-inside seat to be upholstered for 4 legs

code	finishing	q.kit	q.pack	a	b	kg.x1	vol.x1
132203-063	● nero/black	x1	10	490	470	1,90	mc. 0.011

for the components below, see page 120

04 05 06 07 09

moon

swivel

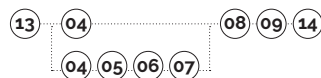

main component sizes

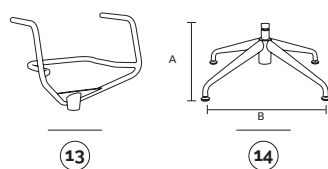

13

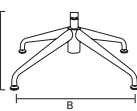

14

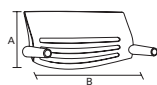

04

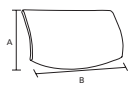

05

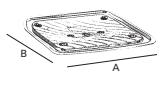

08



09

13 moon-telaio girevole d.25 con braccioli senza tappi moon-d.25 metal frame with swivel arms without caps

code	finishing	q.kit	q.pack	kg.x1	vol.x1
110903-036	● nero/black	x1	60	4,70	mc. 0,045
110904-036	● grigio/grey ikea 4	x1	60	4,70	mc. 0,045
110910-036	● cromato/chrome	x1	60	4,70	mc. 0,045

14 moon-base 4 razze d.650 con meccanismo assemblato di ritorno automatico moon-four-star base d.650 with auto-return swivel mechanism assembled

code	finishing	q.kit	q.pack	a	b	kg.x1	vol.x1
110210-065	● cromato/chrome	x1	100	290	500	3,00	mc. 0,04

04 moon-schienale esterno portante con accessori moon-inside back carrier with accessories

code	finishing	q.kit	q.pack	a	b	kg.x1	vol.x1
132103-052	● nero/black	x1	12	270	510	1,60	mc. 0,017
132105-052	○ bianco/white	x1	12	270	510	1,60	mc. 0,017

05 moon-pannello schienale da tappezzare moon-back pannel for upholstery

code	finishing	q.kit	q.pack	a	b	kg.x1	vol.x1
132103-053	● nero/black	x1	20	300	400	0,29	mc. 0,003

06 vite hilo tlb+ 5x12 clipper zincata nera screw hilo tlb+ 5x12 clipper zinc black

code	finishing	q.kit
117803-151	● nero/black	x6

07 coprivite clipper in plastica screw cover clipper in plastic

code	finishing	q.kit
134403-200	● nero/black	x6
134405-200	○ bianco/white	x6

08 moon-sedile interno da tappezzare moon-inside seat to be upholstered

code	finishing	q.kit	q.pack	a	b	kg.x1	vol.x1
132203-061	● nero/black	x1	10	490	470	1,90	mc. 0,011

09 moon-sottosedile esterno plastica nero + 8 viti moon-external black plastic underseat + 8 screws

code	finishing	q.kit	q.pack	a	b	kg.x1	vol.x1
132203-064	● nero/black	x1	20	470	440	0,57	mc. 0,0025





BEYOND **Innovation**





spot



spot



components



EN 15372:2016
EN 1730:2012

tools



certification



patent



video

spot showing

features



designed by:
esedra



La gamba pieghevole pratica e innovativa.

Senza struttura centrale, la gamba **Spot** nelle tre larghezze, garantisce la realizzazione di tavoli pieghevoli in svariate dimensioni.

Plus:

- è asimmetrica e ben si adatta a tutte le dimensioni di top;
- è pieghevole e come tale garantisce la totale accatastabilità dei tavoli;
- è dotata di piedini regolabili, rendendo facile adattare il tavolo in qualsiasi punto della sala.

Spot è la gambe ideale per qualsiasi **ambiente Conference e Catering**.

A practical and innovative folding leg.

Spot legs come in three widths, and the absence of a central structure means folding tables in any top size can be produced without constraint.

Advantages:

- asymmetric design makes it ideal for all sizes of tops;
- foldable, thus guaranteeing total stackability of tables;
- equipped with adjustable feet, making it easy to adapt the table to any location in room.

Spot is the ideal leg for any **Conference and Catering environment**.

spot

components

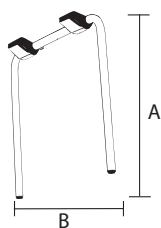

spot-gamba pieghevole d.35 h.700 per piano da 800 con accessori-scatoia da due pezzi
spot-leg folding d.35 h.700 to plan for 800 with accessories-two pieces box

code	finishing	q.kit	q.pack	a	b	kg.x1	vol.x1
110304-014	● grigio/grey	x2	2	700	750	4,80	mc. 0.03
110305-014	○ bianco/white	x2	2	700	750	4,80	mc. 0.03
110310-090	● cromato/chrome	x2	2	700	750	4,80	mc. 0.03

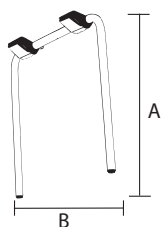
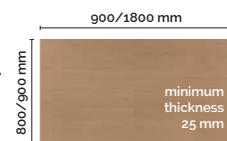

spot-gamba pieghevole d.35 h.700 per piano da 700 con accessori-scatoia da due pezzi
spot-leg folding d.35 h.700 to plan for 700 with accessories-two pieces box

code	finishing	q.kit	q.pack	a	b	kg.x1	vol.x1
110304-038	● grigio/grey	x2	2	700	650	4,64	mc. 0.03
110305-013	○ bianco/white	x2	2	700	650	4,64	mc. 0.03
110310-093	● cromato/chrome	x2	2	700	650	4,64	mc. 0.03

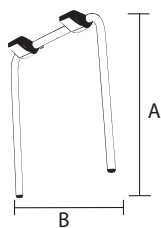

spot-gamba pieghevole d.35 h.700 per piano da 600 con accessori-scatoia da due pezzi
spot-leg folding d.35 h.700 to plan for 600 with accessories-two pieces box

code	finishing	q.kit	q.pack	a	b	kg.x1	vol.x1
110304-039	● grigio/grey	x2	2	700	550	4,48	mc. 0.03
110305-039	○ bianco/white	x2	2	700	550	4,48	mc. 0.03
110310-096	● cromato/chrome	x2	2	700	550	4,48	mc. 0.03



spot-coppia agganci per unione piani tavoli in plastica+viti
spot-pair of plastic hooks to link the top tables + screws

code	finishing	q.kit	q.pack	kg.x1
134003-136	● nero/black	x2	10	0,0005



spot-carrello portatavoli con accessori
spot-trolley for tables with accessories

code	finishing	kg.x1
110803-028	● nero/black	
110804-028	● grigio/grey	

spot

components

6 simple movements

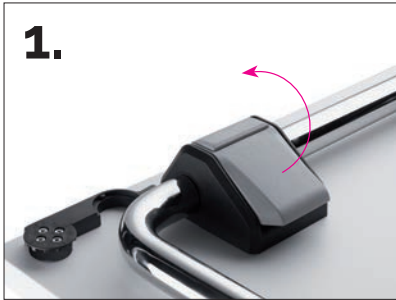





square



square



slide
slide w/armrests

4 legs
4 legs w/armrest
4 legs w/writing tablet

4 legs with castors
4 legs with castors w/armrest

swivel
swivel w/armrest

bench
bench w/armrest



EN 13761



EN 16139



BIFMA TEST

tools

square showing



certification

features



trolley available



designed by:
r&d albacomponents



La sedia versatile e caratterizzante.

Ampla e confortevole, funzionale a utilizzi diversi, prevede schienale e sedile in diverse varianti: da tappezzare, in plastica a vista, con possibili pannellini da tappezzare, in multistrato faggio verniciato. Grazie alle numerose opzioni e versioni di telai disponibili, si adatta a molteplici utilizzi.

Plus:

- telaio con sezione del tubo rettangolare che la contraddistingue sul mercato;
- seduta ampia e confortevole;
- massima versatilità
- qualità certificata CATAS.

Square è indicata per l'ambiente Office e l'ambiente Contract.

A versatile and distinctive chair.

A generous, comfortable and functional chair making it ideal for diverse settings. Available in a range of backrest and seat variations: to be upholstered, in bare plastic, with the possibility of including a seat pad to be upholstered, in varnished beech plywood. Thanks to the large number of options and frame versions available, Square is suitable for multiple uses.

Advantages:

- frame with highly distinctive rectangular-section tube;
- features a generous, comfortable seat;
- maximum versatility;
- CATAS certified quality.

Square is suitable for Office and the Contract environments.

square

4-legs



CERTIFIED BY
BIFMA
CATAS

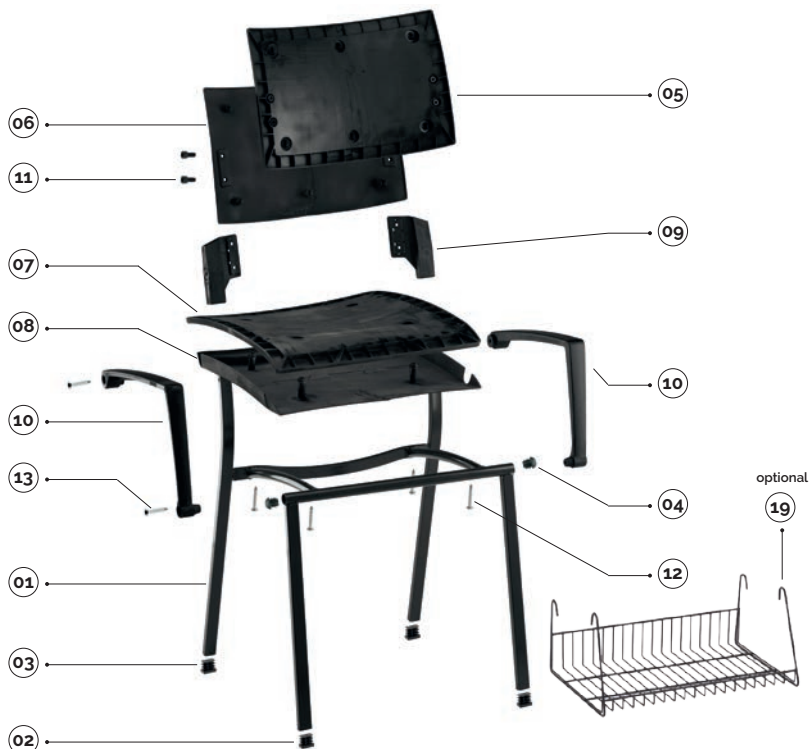

square-carrello portasedie con accessori
square-trolley for chairs with accessories

code	finishing	q.kit
110803-371	● nero/black	x1

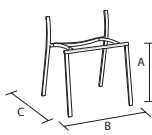
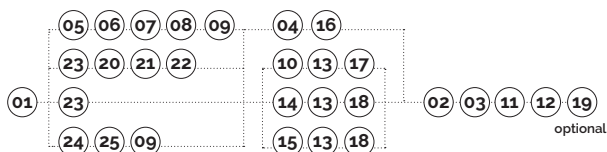

01

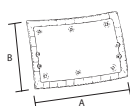

05

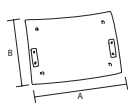

06

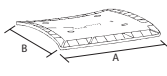

07

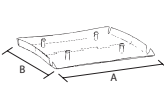

08

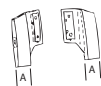

09

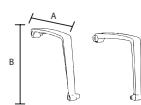

10

19 square-cestello portariviste
square-basket tray

code	finishing	q.kit
113403-003	● nero/black	x1

11 vite testa cilindrica a croce m6x16 zincata
screw cylindrical cross head m6x16 zinc

code	finishing	q.kit
117711-191	○ zincata/zinc	x4

01 square-telaio per sedia fissa senza tappi sottopiede montati
square-fixed frame for chair without caps

code	finishing	q.kit	q.pack	a	b	c	kg.x1	vol.x1
112603-025	● nero/black	x1	80	450	500	500	3,20	mc. 0.003
112604-025	● grigio/grey	x1	80	450	500	500	3,20	mc. 0.003
112610-025	● cromato/chrome	x1	80	450	500	500	3,20	mc. 0.003

02 confezione puntali rettangolari 25x15
black inner flat rectangular caps 25x15 package

code	finishing	q.kit	q.pack					
137003-074'	● nero/black	x2	160	*forniti nella stessa confezione				
134204-020	● grigio/grey	x2		supplied in the same package				

03 confezione puntali inclinati rettangolari 25x15
black inner oblique rectangular caps 25x15 package

code	finishing	q.kit	q.pack					
137003-074'	● nero/black	x2	160	*forniti nella stessa confezione				
134204-023	● grigio/grey	x2		supplied in the same package				

04 tappo copritesta 022 per sedia senza braccioli
cover head cap 022 for chair without arms

code	finishing	q.kit					
134103-220	● nero/black	x2					
134104-220	● grigio/grey	x2					

05 square-shi-schienale interno in plastica
square-shi-inner plastic back

code	finishing	q.kit	q.pack	a	b	kg.x1	vol.x1
132103-006	● nero/black	x1	20	440	290	0,55	mc. 0.004

06 square-she-schienale esterno in plastica
square-she-outer plastic back

code	finishing	q.kit	q.pack	a	b	kg.x1	vol.x1
132103-005	● nero/black	x1	20	425	280	0,37	mc. 0.004
132104-026	● grigio/grey	x1	20	425	280	0,37	mc. 0.004

07 square-sedile interno in plastica
square-inner plastic seat

code	finishing	q.kit	q.pack	a	b	kg.x1	vol.x1
132203-007	● nero/black	x1	20	440	460	0,90	mc. 0.005

08 square-sedile esterno in plastica
square-outer plastic seat

code	finishing	q.kit	q.pack	a	b	kg.x1	vol.x1
132203-006	● nero/black	x1	20	430	450	0,53	mc. 0.008
132204-026	● grigio/grey	x1	20	430	450	0,53	mc. 0.008

09 square-coppia supporti schienale in plastica
square-plastic pair of supports for back

code	finishing	q.kit	q.pack	a	kg.x1	vol.x1
134003-087	● nero/black	x1	40	25x15	0,16	mc. 0.0002
134004-022	● grigio/grey	x1	40	25x15	0,16	mc. 0.0002

10 square-coppia braccioli in plastica
square-plastic pair arms

code	finishing	q.kit	q.pack	a	b	kg.x1	vol.x1
131703-005	● nero/black	x1	10	360	260	0,70	mc. 0.006
131704-005	● grigio/grey	x1	10	360	260	0,70	mc. 0.006

12 vite testa svasata a croce m6x30 zincata (vite per fissaggio sedile)
screw flared head m6x30 zinc (screw for six seat)

code	finishing	q.kit
117711-192	○ zincata/zinc	x4

13 vite autofilettante 5,5x45 testa svasata a croce
screw auto-threading 5,5x45 flared cross

code	finishing	q.kit
117811-168	○ zincata/zinc	x4

square

4-legs/tablet and hook options



14

15

14 15 bracciolo destro/sinistro con gancio portavoletta right/left arm with attachment for tablet

code	finishing		q.kit	q.pack	kg.x1	vol.x1
131703-009	● nero/black	destro/right	x1	20	0,70	mc. 0,006
131703-006	● nero/black	sinistro/left	x1	20	0,70	mc. 0,006
131704-003	● grigio/grey	destro/right	x1	20	0,70	mc. 0,006
131704-004	● grigio/grey	sinistro/left	x1	20	0,70	mc. 0,006

TLT tablet



TLT2 tablet



TLT3 tablet



BEAN tablet



TL02 tablet



SPT2 mechanism tablet



SPTA mechanism antipanic



for writing tablet options, see page 242/243



16

16 17 18 aggancio laterale maschio+femmina in plastica + 2 viti plastic lateral hook male+female and 2 screws

code	finishing		q.kit	q.pack	kg.x1	vol.x1
134003-130	● nero/black		x1	100	0,03	mc. 0,0001
134003-131	● nero/black	per bracciolo/for arm	x1	100	0,03	mc. 0,0001
134003-138	● nero/black	per bracciolo con portavoletta/ for arm with attachment for tablet	x1	100	0,03	mc. 0,0001



17

18

4-legs/backrest and seat options

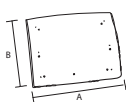

20

22



21



20 pannello schienale da tappezzare panel back for upholstery

code	finishing		q.kit	q.pack	a	b	kg.x1	vol.x1
132103-046	● nero/black		x1	20	390	310	0,50	mc. 0,004

21 pannello sedile da tappezzare panel seat for upholstery

code	finishing		q.kit	q.pack	a	b	kg.x1	vol.x1
132203-046	● nero/black		x1	20	400	450	0,60	mc. 0,004

22 confezione viti tbl+ fr. d.5x14 per pannello da tappezzare screws tbl+ fr.hilo d.5x14 zinc.black (to fix seat panel) package

code	finishing		q.kit	q.pack
117003-071	● nero/black		x4	200

23 square-coppia sedile schienale in plastica colorato square-plastic seat/back coloured at sight

code	finishing		q.kit	q.pack	a	b	c	d	kg.x1	vol.x1
134003-088	● nero/black		x1	10	450	440	500	300	1,62	mc. 0,012
134004-023	● grigio/grey	RAL7040	x1	10	450	440	500	300	1,62	mc. 0,012
134002-023	● rosso/red	PPL42	x1	10	450	440	500	300	1,62	mc. 0,012
134015-023	● blu/blue	RAL5002	x1	10	450	440	500	300	1,62	mc. 0,012
134007-023	● arancio/orange	PPL22	x1	10	450	440	500	300	1,62	mc. 0,012
134005-023	● beige/beige	PPL09	x1	10	450	440	500	300	1,62	mc. 0,012

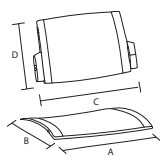

23

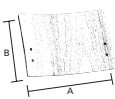

24



24 schienale in multistrato faggio + viti back in plywood beech with screws

code	finishing		q.kit	q.pack	a	b	kg.x1
122107-010	● faggio/beech wood		x1	15	425	280	0,50

25 square sdlf-sedile multistrato faggio verniciato + viti square sdlf-painted beech wood seat with screws

code	finishing		q.kit	q.pack	a	b	kg.x1
122207-015	● faggio/beech wood		x1	15	422	280	1,65

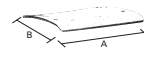

25

optional

main component sizes

square

4-legs for castors

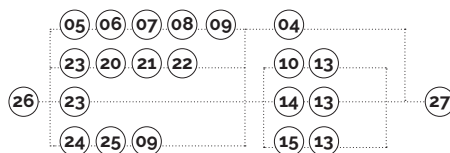

square-carrello portasedie con accessori
square-trolley for chairs with accessories

code	finishing	q.kit
110803-371	● nero/black	x1

26 telaio per sedia 4 gambe predisposto per 4 ruote + 4 tappi porta ruote
frame for chair issued for 4 wheels + 4 inner black caps for castors

code	finishing	q.kit	q.pack	a	b	c	kg.x1	vol.x1
112603-027	● nero/black	x1	80	450	500	500	3,10	mc. 0,003
112604-027	● grigio/grey	x1	80	450	500	500	3,10	mc. 0,003
112610-027	● cromato/chrome	x1	80	450	500	500	3,10	mc. 0,003

04 tappo copritesta 022 per sedia senza braccioli
cover head cap 022 for chair without arms

code	finishing	q.kit
134103-220	● nero/black	x2
134104-220	● grigio/grey	x2

23 square-coppia sedile schienale in plastica colorato
square-plastic seat/back coloured at sight

code	finishing	q.kit	q.pack	a	b	c	d	kg.x1	vol.x1
134003-088	● nero/black	x1	10	450	440	500	300	1,62	mc. 0,012
134004-023	● grigio/grey	x1	10	450	440	500	300	1,62	mc. 0,012
134002-023	● rosso/red	x1	10	450	440	500	300	1,62	mc. 0,012
134015-023	● blu/blue	x1	10	450	440	500	300	1,62	mc. 0,012
134007-023	● arancio/orange	x1	10	450	440	500	300	1,62	mc. 0,012
134005-023	● beige/beige	x1	10	450	440	500	300	1,62	mc. 0,012

20 pannello schienale da tappezzare
panel back for upholstery

code	finishing	q.kit	q.pack	a	b	kg.x1	vol.x1
132103-046	● nero/black	x1	20	390	310	0,50	mc. 0,004

21 pannello sedile da tappezzare
panel seat for upholstery

code	finishing	q.kit	q.pack	a	b	kg.x1	vol.x1
132203-046	● nero/black	x1	20	400	450	0,60	mc. 0,004

10 square-coppia braccioli in plastica
square-plastic pair arms

code	finishing	q.kit	q.pack	a	b	kg.x1	vol.x1
131703-005	● nero/black	x1	10	360	260	0,70	mc. 0,006
131704-005	● grigio/grey	x1	10	360	260	0,70	mc. 0,006

22 confezione viti tbl+ fr. d.5x14 per pannello da tappezzare
screws tbl+ fr.hilo d.5x14 zinc.black (to fix seat panel) package

code	finishing	q.kit	q.pack
117003-071	● nero/black	x4	200

27 doppia ruota ø36 in pa (ricoperta pur)
pa twin wheel castor ø36 (covered with pur)

code	finishing	q.kit
134403-001	● nero/black	x4

27 gambo godronato ø8 zincato
zinc plated knured ø8 stem

code	finishing	q.kit
117911-300	○ zincata/zinc	x4

14 **15** bracciolo destro/sinistro con gancio portavoiletta
right/left arm with attachment for tablet

code	finishing	q.kit	q.pack	kg.x1	vol.x1
131703-009	● nero/black	x1	20	0,70	mc. 0,006
131703-006	● nero/black	x1	20	0,70	mc. 0,006
131704-003	● grigio/grey	x1	20	0,70	mc. 0,006
131704-004	● grigio/grey	x1	20	0,70	mc. 0,006

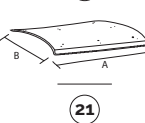
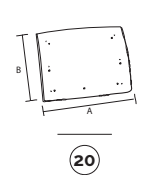
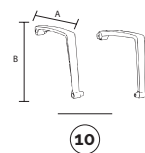
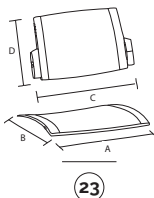
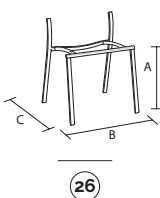

main component sizes

optional

square

4-legs for castors/backrest and seat options

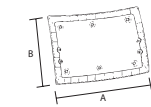

05

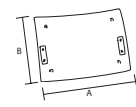

06



07



08

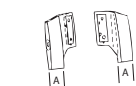

09



05 square-shi-schienale interno in plastica
square-shi-inner plastic back

code	finishing	q.kit	q.pack	a	b	kg.x1	vol.x1
132103-006	● nero/black	x1	20	440	290	0,55	mc. 0,004

06 square-she-schienale esterno in plastica
square-she-outer plastic back

code	finishing	q.kit	q.pack	a	b	kg.x1	vol.x1
132103-005	● nero/black	x1	20	425	280	0,37	mc. 0,004
132104-026	● grigio/grey	x1	20	425	280	0,37	mc. 0,004

07 square-sedile interno in plastica
square-inner plastic seat

code	finishing	q.kit	q.pack	a	b	kg.x1	vol.x1
132203-007	● nero/black	x1	20	440	460	0,90	mc. 0,005

08 square-sedile esterno in plastica
square-outer plastic seat

code	finishing	q.kit	q.pack	a	b	kg.x1	vol.x1
132203-006	● nero/black	x1	20	430	450	0,53	mc. 0,008
132204-026	● grigio/grey	x1	20	430	450	0,53	mc. 0,008

09 square-coppia supporti schienale in plastica
square-plastic pair of supports for back

code	finishing	q.kit	q.pack	a	kg.x1	vol.x1
134003-087	● nero/black	x1	40	25x15	0,16	mc. 0,0002
134004-022	● grigio/grey	x1	40	25x15	0,16	mc. 0,0002

and 11 12 04

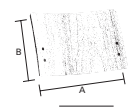

24

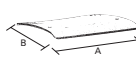

25



24 schienale in multistrato faggio + viti
back in plywood beech with screws

code	finishing	q.kit	q.pack	a	b	kg.x1
122107-010	● faggio/beech wood	x1	15	425	280	0,50

25 square sdlf-sedile multistrato faggio verniciato + viti
square sdlf-painted beech wood seat with screws

code	finishing	q.kit	q.pack	a	b	kg.x1
122207-015	● faggio/beech wood	x1	15	422	280	1,65

and 09 10 13

main component sizes

square

slide

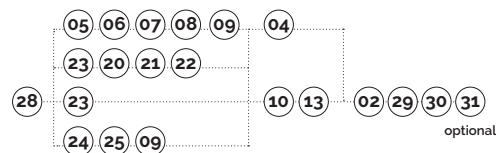

main component sizes

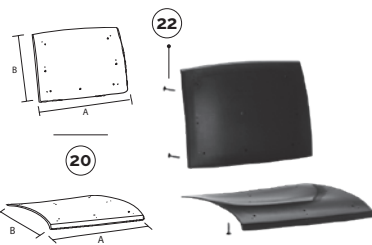
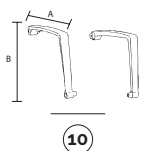
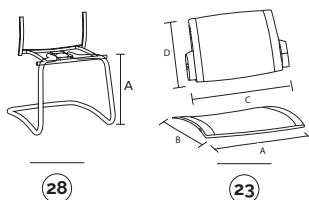

28 base slitta slide bases

code	finishing	q.kit	q.pack	a	kg.x1	vol.x1
110503-013	● nero/black	x1	80	450	6,50	mc. 0.03
110504-017	● grigio/grey	x1	80	450	6,50	mc. 0.03
110510-016	● cromato/chrome	x1	80	450	6,50	mc. 0.03

29 p2p pinza due pioli politene nera p2p two-pins plier in black polythene

code	finishing	q.kit
134003-003	● nero/black	x4

30 tappo copritesta alettato d.25 nero ribbed insert d.25 black

code	finishing	q.kit
134103-250	● nero/black	x2

31 piedino antiribaltamento in plastica nera plastic black feet anti-upsetting

code	finishing	q.kit	q.pack	kg.x1	vol.x1
134303-006	● nero/black	x2	100	0,025	mc. 0.0001

23 square-coppia sedile schienale in plastica colorato square-plastic seat/back coloured at sight

code	finishing	q.kit	q.pack	a	b	c	d	kg.x1	vol.x1
134003-088	● nero/black	x1	10	450	440	500	300	1,62	mc. 0.012
134004-023	● grigio/grey ral7040	x1	10	450	440	500	300	1,62	mc. 0.012
134002-023	● rosso/red ppl42	x1	10	450	440	500	300	1,62	mc. 0.012
134015-023	● blu/blue rat5002	x1	10	450	440	500	300	1,62	mc. 0.012
134007-023	● arancio/orange ppl22	x1	10	450	440	500	300	1,62	mc. 0.012
134005-023	● beige/beige ppl09	x1	10	450	440	500	300	1,62	mc. 0.012

20 pannello schienale da tappezzare panel back for upholstery

code	finishing	q.kit	q.pack	a	b	kg.x1	vol.x1
132103-046	● nero/black	x1	20	390	310	0,50	mc. 0.004

21 pannello sedile da tappezzare panel seat for upholstery

code	finishing	q.kit	q.pack	a	b	kg.x1	vol.x1
132203-046	● nero/black	x1	20	400	450	0,60	mc. 0.004

10 square-coppia braccioli in plastica square-plastic pair arms

code	finishing	q.kit	q.pack	a	b	kg.x1	vol.x1
131703-005	● nero/black	x1	10	360	260	0,70	mc. 0.006
131704-005	● grigio/grey	x1	10	360	260	0,70	mc. 0.006

22 confezione viti tbl+ fr. d.5x14 per pannello da tappezzare screws tbl+ fr.hilo d.5x14 zinc.black (to fix seat panel) package

code	finishing	q.kit	q.pack
117003-071	● nero/black	x4	200

02 puntale alettato rettangolare 25x15 ribbed rectangular insert 25x15

code	finishing	q.kit
134203-020	● nero/black	x2
134204-020	● grigio/grey	x2

04 tappo copritesta 022 per sedia senza braccioli cover head cap 022 for chair without arms

code	finishing	q.kit
134103-220	● nero/black	x2
134104-220	● grigio/grey	x2

square

slide/ backrest and seat options

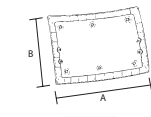

05

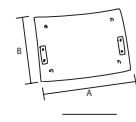

06

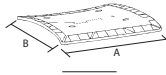

07

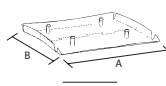

08

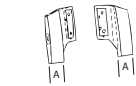

09



05 square-shi-schienale interno in plastica
square-shi-inner plastic back

code	finishing	q.kit	q.pack	a	b	kg.x1	vol.x1
132103-006	● nero/black	x1	20	440	290	0,55	mc. 0,004

06 square-she-schienale esterno in plastica
square-she-outer plastic back

code	finishing	q.kit	q.pack	a	b	kg.x1	vol.x1
132103-005	● nero/black	x1	20	425	280	0,37	mc. 0,004
132104-026	● grigio/grey	x1	20	425	280	0,37	mc. 0,004

07 square-sedile interno in plastica
square-inner plastic seat

code	finishing	q.kit	q.pack	a	b	kg.x1	vol.x1
132203-007	● nero/black	x1	20	440	460	0,90	mc. 0,005

08 square-sedile esterno in plastica
square-outer plastic seat

code	finishing	q.kit	q.pack	a	b	kg.x1	vol.x1
132203-006	● nero/black	x1	20	430	450	0,53	mc. 0,008
132204-026	● grigio/grey	x1	20	430	450	0,53	mc. 0,008

09 square-coppia supporti schienale in plastica
square-plastic pair of supports for back

code	finishing	q.kit	q.pack	a	kg.x1	vol.x1
134003-087	● nero/black	x1	40	25x15	0,16	mc. 0,0002
134004-022	● grigio/grey	x1	40	25x15	0,16	mc. 0,0002

and · 11 12 10 13 02

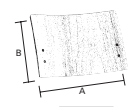

24

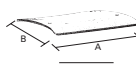

25



24 schienale in multistrato faggio + viti
back in plywood beech with screws

code	finishing	q.kit	q.pack	a	b	kg.x1
122107-010	● faggio/beech wood	x1	15	425	280	0,50

25 square sdlf-sedile multistrato faggio verniciato + viti
square sdlf-painted beech wood seat with screws

code	finishing	q.kit	q.pack	a	b	kg.x1
122207-015	● faggio/beech wood	x1	15	422	280	1,65

and · 09 04 02

main component sizes

square

swivel

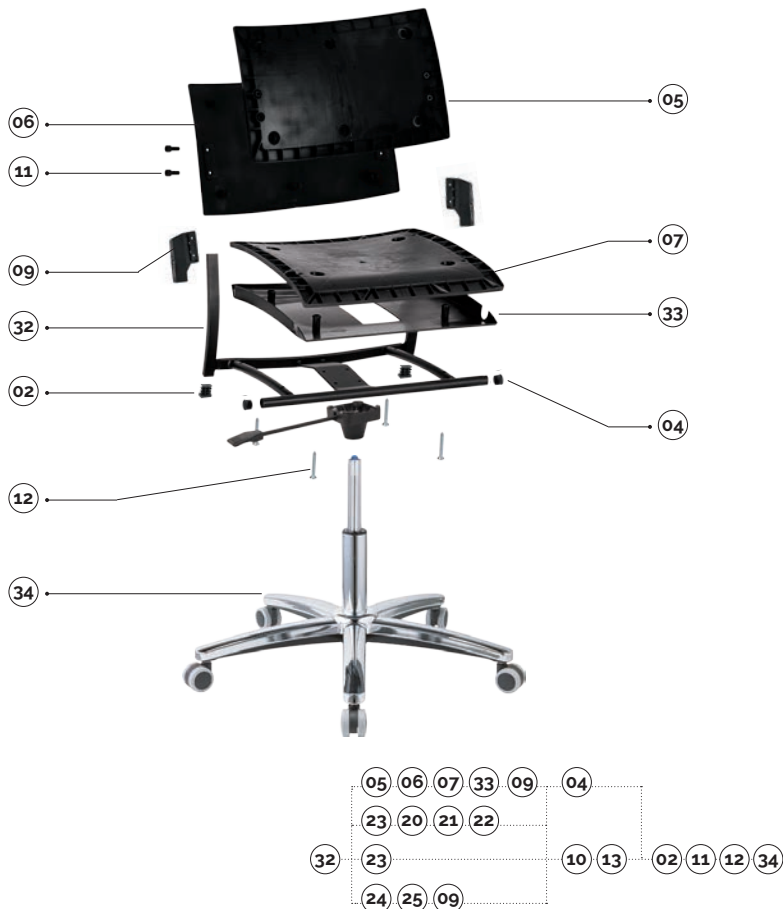

main component sizes

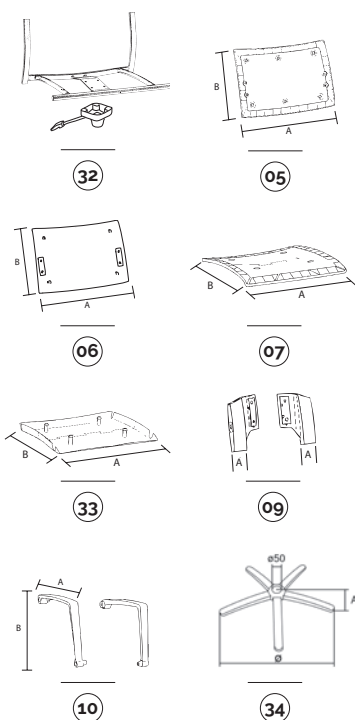

32 telaio girevole con blocchetto comando a gas
swivel frame gas with lever

code	finishing	q.kit	q.pack	kg.x1	vol.x1
112603-029	● nero/black	x1	100	3,50	mc. 0,05
112604-029	● grigio/grey	x1	100	3,50	mc. 0,05

02 puntale alettato rettangolare 25x15
ribbed rectangular insert 25x15

code	finishing	q.kit
134203-020	● nero/black	x2
134204-020	● grigio/grey	x2

04 tappo copritesta 022 per sedia senza braccioli
cover head cap 022 for chair without arms

code	finishing	q.kit
134103-220	● nero/black	x2
134104-220	● grigio/grey	x2

05 square-shi-schienale interno in plastica
square-shi-inner plastic back

code	finishing	q.kit	q.pack	a	b	kg.x1	vol.x1
132103-006	● nero/black	x1	20	440	290	0,55	mc. 0,004

06 square-she-schienale esterno in plastica
square-she-outer plastic back

code	finishing	q.kit	q.pack	a	b	kg.x1	vol.x1
132103-005	● nero/black	x1	20	425	280	0,37	mc. 0,004
132104-026	● grigio/grey	x1	20	425	280	0,37	mc. 0,004

07 square-sedile interno in plastica
square-inner plastic seat

code	finishing	q.kit	q.pack	a	b	kg.x1	vol.x1
132203-007	● nero/black	x1	20	440	460	0,90	mc. 0,005

33 square-sedile esterno in plastica
square-outer plastic seat

code	finishing	q.kit	q.pack	a	b	kg.x1	vol.x1
132203-008	● nero/black	x1	20	430	450	0,53	mc. 0,008
132204-027	● grigio/grey	x1	20	430	450	0,53	mc. 0,008

09 square-coppia supporti schienale in plastica
square-plastic pair of supports for back

code	finishing	q.kit	q.pack	a	kg.x1	vol.x1
134003-087	● nero/black	x1	40	25x15	0,16	mc. 0,0002
134004-022	● grigio/grey	x1	40	25x15	0,16	mc. 0,0002

10 square-coppia braccioli in plastica
square-plastic pair arms

code	finishing	q.kit	q.pack	a	b	kg.x1	vol.x1
131703-005	● nero/black	x1	10	360	260	0,70	mc. 0,006
131704-005	● grigio/grey	x1	10	360	260	0,70	mc. 0,006

11 vite testa cilindrica a croce m6x16 zincata
screw cylindrical cross head m6x16 zinc

code	finishing	q.kit
117711-191	○ zincata/zinc	x4

12 vite testa svasata a croce m6x30 zincata (vite per fissaggio sedile)
screw flared head m6x30 zinc (screw for six seat)

code	finishing	q.kit
117711-192	○ zincata/zinc	x4

34 b40 base in metallo d.640 con coprisaldatura
b40 metal base d.640 with cover welding

code	finishing	q.kit	q.pack	a	o	kg.x1	vol.x1
110210-027	● cromato/chrome	x1	5	60	640	2,85	mc. 0,014

square

swivel/backrest and seat options

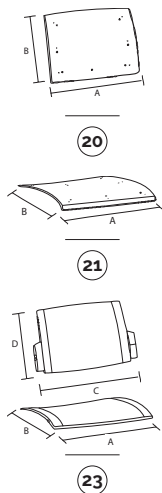

23 square-coppia sedile schienale in plastica colorato square-plastic seat/back coloured at sight

code	finishing	q.kit	q.pack	a	b	c	d	kg.x1	vol.x1
134003-088	● nero/black	x1	10	450	440	500	300	1.62	mc. 0,012
134004-023	● grigio/grey RAL7040	x1	10	450	440	500	300	1.62	mc. 0,012
134002-023	● rosso/red PPL42	x1	10	450	440	500	300	1.62	mc. 0,012
134015-023	● blu/blue RAL5002	x1	10	450	440	500	300	1.62	mc. 0,012
134007-023	● arancio/orange PPL22	x1	10	450	440	500	300	1.62	mc. 0,012
134005-023	● beige/beige PPL09	x1	10	450	440	500	300	1.62	mc. 0,012

20 pannello schienale da tappezzare panel back for upholstery

code	finishing	q.kit	q.pack	a	b	kg.x1	vol.x1
132103-046	● nero/black	x1	20	390	310	0,50	mc. 0,004

21 pannello sedile da tappezzare panel seat for upholstery

code	finishing	q.kit	q.pack	a	b	kg.x1	vol.x1
132203-046	● nero/black	x1	20	400	450	0,60	mc. 0,004

22 confezione viti tbl+ fr. d.5x14 per pannello da tappezzare screws tbl+ fr.hilo d.5x14 zinc.black (to fix seat panel) package

code	finishing	q.kit	q.pack
117003-071	● nero/black	x4	200

and - 04 02

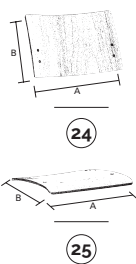

24 schienale in multistrato faggio + viti back in plywood beech with screws

code	finishing	q.kit	q.pack	a	b	kg.x1
122107-010	● faggio/beech wood	x1	15	425	280	0,50

25 square sdlf-sedile multistrato faggio verniciato + viti square sdlf-painted beech wood seat with screws

code	finishing	q.kit	q.pack	a	b	kg.x1
122207-015	● faggio/beech wood	x1	15	422	280	1,65

and - 09 04 02

square bench

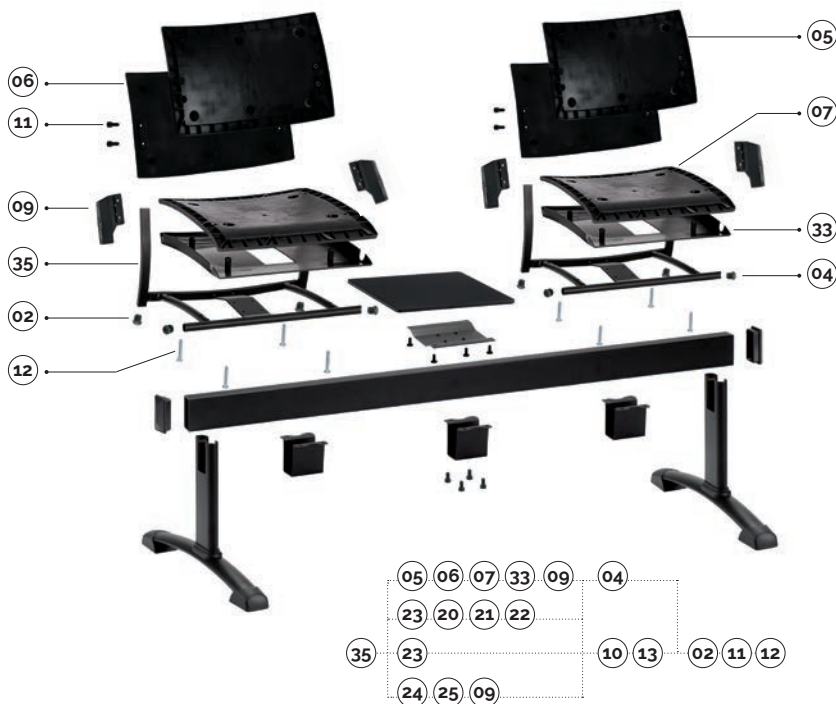

main component sizes

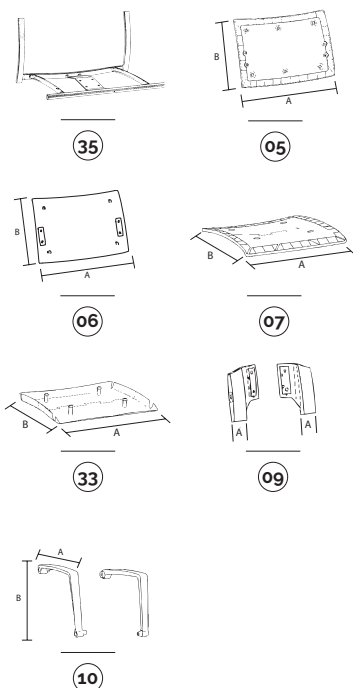

35 square.p telaio per panca tappi esclusi square.p bench frame caps excluded

code	finishing	q.kit	q.pack	kg.x1	vol.x1
110703-050	● nero/black	x1	100	2.80	mc. 0.020
110704-063	● grigio/grey	x1	100	2.80	mc. 0.020

02 puntale alettato rettangolare 25x15 ribbed rectangular insert 25x15

code	finishing	q.kit
134203-020	● nero/black	x2
134204-020	● grigio/grey	x2

04 tappo copritesta 022 per sedia senza braccioli cover head cap 022 for chair without arms

code	finishing	q.kit
134103-220	● nero/black	x2
134104-220	● grigio/grey	x2

05 square-shi-schienale interno in plastica square-shi-inner plastic back

code	finishing	q.kit	q.pack	a	b	kg.x1	vol.x1
132103-006	● nero/black	x1	20	440	290	0.55	mc. 0.004

06 square-she-schienale esterno in plastica square-she-outer plastic back

code	finishing	q.kit	q.pack	a	b	kg.x1	vol.x1
132103-005	● nero/black	x1	20	425	280	0.37	mc. 0.004
132104-026	● grigio/grey	x1	20	425	280	0.37	mc. 0.004

07 square-sedile interno in plastica square-inner plastic seat

code	finishing	q.kit	q.pack	a	b	kg.x1	vol.x1
132203-007	● nero/black	x1	20	440	460	0.90	mc. 0.005

33 square-sedile esterno in plastica square-outer plastic seat

code	finishing	q.kit	q.pack	a	b	kg.x1	vol.x1
132203-008	● nero/black	x1	20	430	450	0.53	mc. 0.008
132204-027	● grigio/grey	x1	20	430	450	0.53	mc. 0.008

09 square-coppia supporti schienale in plastica square-plastic pair of supports for back

code	finishing	q.kit	q.pack	a	kg.x1	vol.x1
134003-087	● nero/black	x1	40	25x15	0.16	mc. 0.0002
134004-022	● grigio/grey	x1	40	25x15	0.16	mc. 0.0002

10 square-coppia braccioli in plastica square-plastic pair arms

code	finishing	q.kit	q.pack	a	b	kg.x1	vol.x1
131703-005	● nero/black	x1	10	360	260	0.70	mc. 0.006
131704-005	● grigio/grey	x1	10	360	260	0.70	mc. 0.006

11 vite testa cilindrica a croce m6x16 zincata screw cylindrical cross head m6x16 zinc

code	finishing	q.kit
117711-191	○ zincata/zinc	x4

12 vite testa svasata a croce m6x30 zincata (vite per fissaggio sedile) screw flared head m6x30 zinc (screw for six seat)

code	finishing	q.kit
117711-192	○ zincata/zinc	x4

for the bench components, see page 249

OPTIONAL
bench
connector

E-USB **NEW**
bench plug



JIM **NEW**
bench leg

APOLL
bench arm



plastic

90GM
bench leg

90GF
bench leg

100GM
bench leg

200GM
bench leg

PIONEER
bench arm



metal

CUT
bench leg

SLIM
bench leg

CUT
bench arm

SLIM
bench arm



aluminium

square

bench/backrest and seat options

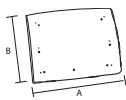

20

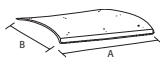

21

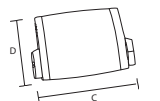

23



23 square-coppia sedile schienale in plastica colorato square-plastic seat/back coloured at sight

code	finishing	q.kit	q.pack	a	b	c	d	kg.x1	vol.x1
134003-088	● nero/black	x1	10	450	440	500	300	1.62	mc. 0,012
134004-023	● grigio/grey RAL7040	x1	10	450	440	500	300	1.62	mc. 0,012
134002-023	● rosso/red PPL42	x1	10	450	440	500	300	1.62	mc. 0,012
134015-023	● blu/blue RAL5002	x1	10	450	440	500	300	1.62	mc. 0,012
134007-023	● arancio/orange PPL22	x1	10	450	440	500	300	1.62	mc. 0,012
134005-023	● beige/beige PPL09	x1	10	450	440	500	300	1.62	mc. 0,012

20 pannello schienale da tappezzare panel back for upholstery

code	finishing	q.kit	q.pack	a	b	kg.x1	vol.x1
132103-046	● nero/black	x1	20	390	310	0,50	mc. 0,004

21 pannello sedile da tappezzare panel seat for upholstery

code	finishing	q.kit	q.pack	a	b	kg.x1	vol.x1
132203-046	● nero/black	x1	20	400	450	0,60	mc. 0,004

22 confezione viti tbl+ fr. d.5x14 per pannello da tappezzare screws tbl+ fr.hilo d.5x14 zinc.black (to fix seat panel) package

code	finishing	q.kit	q.pack
117003-071	● nero/black	x4	200

and · 04 02

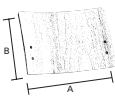

24

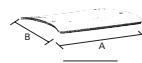

25



24 schienale in multistrato faggio back in plywood beech

code	finishing	q.kit	q.pack	a	b	kg.x1
122107-010	● faggio/beech wood	x1	15	425	280	0,50

25 square sdlf-sedile multistrato faggio verniciato + viti square sdlf-painted beech wood seat with screws

code	finishing	q.kit	q.pack	a	b	kg.x1
122207-015	● faggio/beech wood	x1	15	422	280	1,65

and · 09 04 02



BEYOND **Design**





logan



logan



slide

4 legs

4 legs with castors

swivel

bench

slide w/armrests

4 legs w/armrest

4 legs with castors
w/armrest

swivel w/armrest

slide w/writing tablet

4 legs w/writing tablet

4 legs with castors
w/writing tablet

swivel w/writing tablet



EN 16139



BIFMA TEST

logan showing



tools



certification

features



trolley
available



La seduta certificata CATAS e BIFMA.

Estremamente versatile grazie allo schienale disponibile in plastica pieno o traforato, o da tappezzare o ancora in rete, che le conferisce un design distintivo. È abbinabile a tutti i telai disponibili in assortimento; opzionabili i braccioli in plastica con o senza aggancio porta tavoletta e gli agganci laterali.

Logan garantisce una linea ricca e completa.

Plus:

- qualità certificata CATAS e BIFMA;
- grande versatilità grazie al comodo schienale disponibile in tante alternative;
- linea funzionale e completa.

Logan è ideale per gli **ambienti Office e Community**.

CATAS and BIFMA certified chair.

Offers extreme versatility thanks to the backrest available in solid or perforated plastic, either to be upholstered or in mesh, lending it a distinctive design. It can be combined with all the frames available in our range; optional plastic armrests, with or without writing tablet holder and lateral hooks.

Logan offers a complete and highly versatile line.

Advantages:

- quality is CATAS and BIFMA certified;
- great versatility thanks to the comfortable backrest available in a range of alternatives;
- a functional and complete line.

Logan is ideal for **Office and Community environments**.

logan

slide

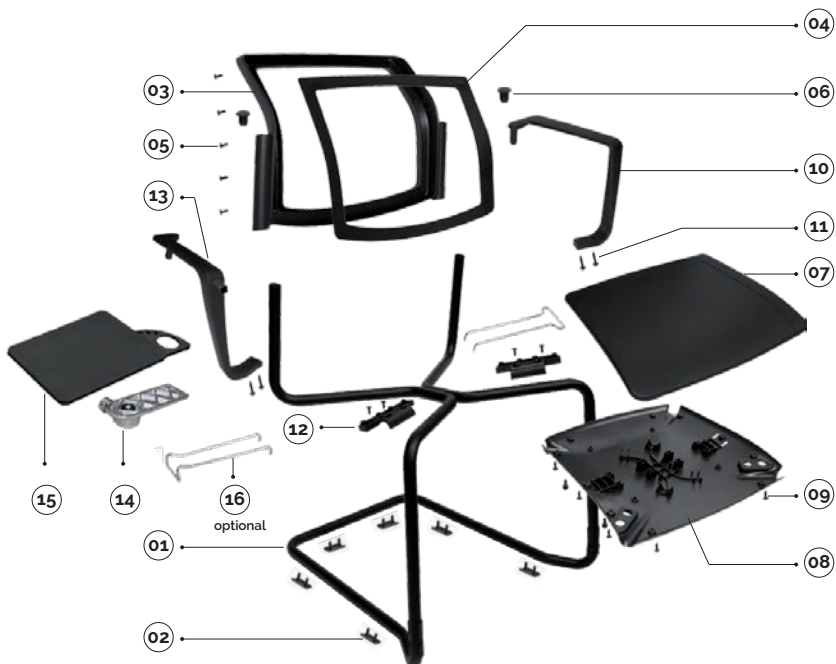

plastic colours

- nero/black
- grigio/gray ral 7040
- bianco/white ral 9003
- blu/blue ral 5014

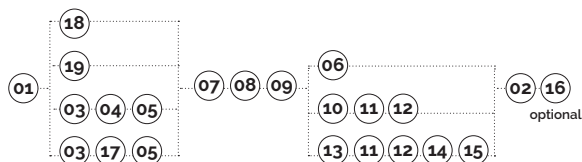

main component sizes

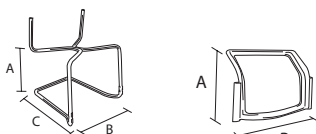

01

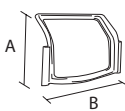

03

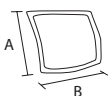

04

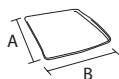

07

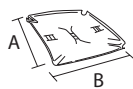

08

optional



16

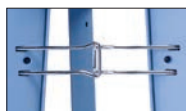

01 logan-base a slitta in tubo asform d.22 tappi esclusi

logan-slide frame asform pipe d.22 without caps

code	finishing	q.kit	q.pack	a	b	c	kg.x1	vol.x1
110503-059	● nero/black	x1	50	450	550	550	4,70	mc. 0.06
110504-059	● grigio/grey ig2621	x1	50	450	550	550	4,70	mc. 0.06
110510-059	● cromato/chrome	x1	50	450	550	550	4,70	mc. 0.06

02 p2p-pinza due pioli in polietilene nera

p2p -two pins pliers in black polythene

code	finishing	q.kit
134003-003	● nero/black	x6

03 logan-telaio schienale in plastica portante

logan-outer back frame in plastic

code	finishing	q.kit	q.pack	a	b	kg.x1	vol.x1
132103-084	● nero/black	x1	10	390	500	0,58	mc. 0.088

04 logan-cornice schienale in plastica per rete

logan-open frame in plastic for mesh

code	finishing	q.kit	q.pack	a	b	kg.x1	vol.x1
132103-085	● nero/black	x1	20	380	420	0,30	mc. 0.005

05 vite hilo tc + 4x14 zn nere

screw hilo tc+ 4x14 zn black

code	finishing	q.kit
117803-120	● nero/black	x10

06 logan-tappo per telaio e schienale

inner caps-cover head d.22

code	finishing	q.kit	q.pack	kg.x1	vol.x1
131703-029	● nero/black	x2	20	0,025	mc. 0.001

07 logan-sedile in plastica colorato a vista

logan-plastic seat coloured at sight

code	finishing	q.kit	q.pack	a	b	kg.x1	vol.x1
132203-082	● nero/black	x1	10	430	460	0,86	mc. 0.01

08 logan-sottosedile in plastica per telaio 4 gambe e slitta

logan-outer plastic seat for four legs and slide

code	finishing	q.kit	q.pack	a	b	kg.x1	vol.x1
132203-080	● nero/black	x1	20	420	450	0,51	mc. 0.007

09 logan-sacchetto con viti + pf1 per 10 sedie - per sedile

logan-screws + pf1 for 10 chairs (screw for fixed seat panel)

code	finishing	q.kit	q.pack
117000-022	● nero/black	x0.1	1

16 logan-coppia agganci laterali maschio + femmina cromati

logan-chrome lateral hooks male + female

code	finishing	q.kit	q.pack	kg.x1	vol.x1
113410-100	● cromato/chrome	x1	100	0,13	mc. 0.0004

logan

slide/tablet accessories

main component sizes

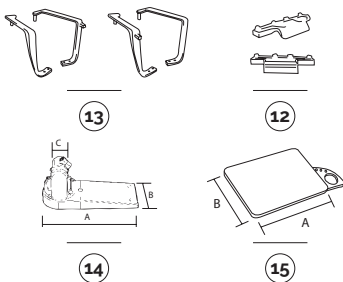

13 logan-coppia braccioli con aggancio portatavoletta in plastica logan-pair of plastic arms right/left with writing tablet hook

code	finishing	q.kit	q.pack	kg.x1	vol.x1
131703-032	● nero/black	x1	10	left + right writing tablet hook	0.49 mc. 0.051
131703-033	● nero/black	x1	10	right + left writing tablet hook	0.49 mc. 0.051

11 logan-kit viti per 10 coppie braccioli logan-kit screws for 10 pair arms

code	finishing	q.kit	q.pack	kg.x1	vol.x1
117000-025	● nero/black	x0.1	1		

12 logan-piastra di fissaggio per bracciolo logan-fixing plate for arm

code	finishing	q.kit	q.pack	kg.x1	vol.x1
131703-034	● nero/black	x2	50	0.07	mc. 0.0013

14 spta-snodo tavoletta antipanico in alluminio lucido spta-polished aluminium swivel safety mechanism for tablet

code	finishing	q.kit	q.pack	a	b	c	kg.x1	vol.x1
111701-900	● alluminio/aluminium destro/right	x1	10	180	66	15x15	0.365	mc. 0.001
111701-901	● alluminio/aluminium sinistro/left	x1	10	180	66	15x15	0.365	mc. 0.001

15 tlt3-tavoletta ambidestro con portabicchiere e portapenne tlt3--writing tablet with cup holder and pen tray

code	finishing	q.kit	q.pack	a	b	kg.x1	vol.x1
134003-041	● nero/black	x1	10	410	300	1.05	mc. 0.036

TLT tablet TLT2 tablet TLT3 tablet BEAN tablet TL02 tablet SPT2 mechanism tablet SPTA mechanism antipanic



for writing tablet options, see page 242/243

slide/options

main component sizes

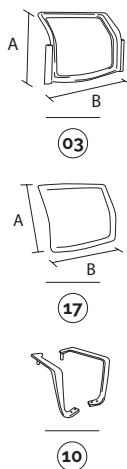

03 logan-telaio schienale in plastica portante logan-outer back frame in plastic

code	finishing	q.kit	q.pack	a	b	kg.x1	vol.x1
132103-084	● nero/black	x1	10	390	500	0.58	mc. 0.088

17 logan-pannello schienale in plastica da tappezzeria logan-plastic panel back for upholstery

code	finishing	q.kit	q.pack	a	b	kg.x1	vol.x1
132103-086	● nero/black	x1	20	380	420	0.90	mc. 0.005

10 logan-coppia braccioli dx/sx in plastica logan-pair of plastic arms right/left

code	finishing	q.kit	q.pack	kg.x1	vol.x1
131703-031	● nero/black	x1	10	0.43	mc. 0.051

and - 05 11 12 07 08 09

main component sizes

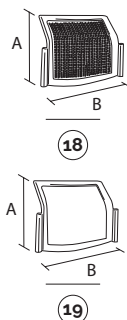

18 logan-schienale traforato in plastica colorato a vista logan-perforated plastic back coloured at sight

code	finishing	q.kit	q.pack	a	b	kg.x1	vol.x1
132103-083	● nero/black	x1	10	390	500	0.82	mc. 0.088

19 logan-schienale pieno in plastica colorato a vista logan-full plastic back coloured at sight

code	finishing	q.kit	q.pack	a	b	kg.x1	vol.x1
132103-089	● nero/black	x1	10	390	500	0.82	mc. 0.088

and - 06 07 08 09



for all colour codes, see page 159

logan

4-legs



CERTIFIED BY
BIFMA
CATAS

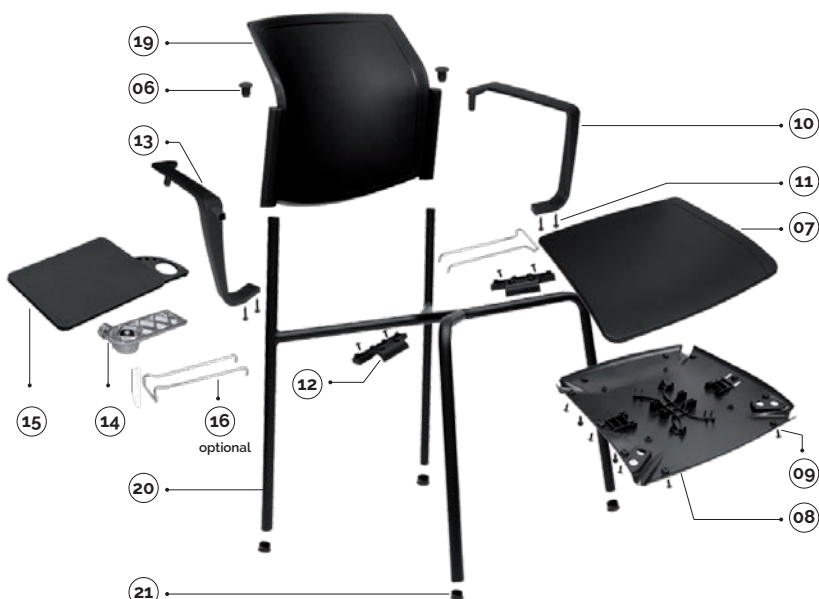

logan-carrello portasedie con accessori
logan-trolley for chairs with accessories

code	finishing	q.kit
110803-344	● nero/black	x1

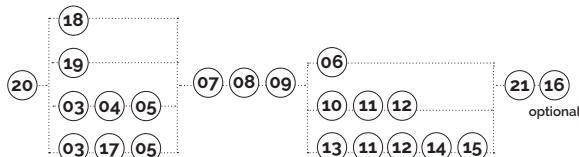

plastic colours

- nero/black
- grigio/gray ral 7040
- bianco/white ral 9003
- blu/blue ral 5014

main component sizes

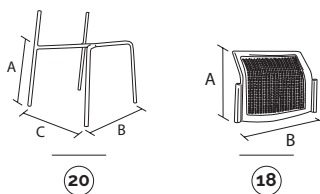

20

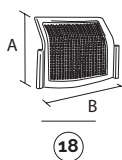

18

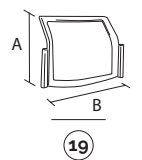

19

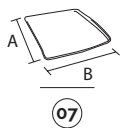

21

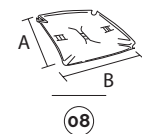

07

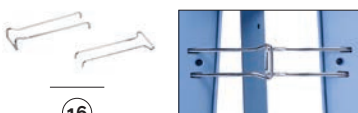

16

optional

20 logan-telaio 4 gambe in tubo d.22 senza tappi logan-fixed four legs frame d.22 without caps

code	finishing	q.kit	q.pack	a	b	c	kg.x1	vol.x1
110603-059	● nero/black	x1	80	440	530	510	2,70	mc. 0.017
110604-059	● grigio/grey ig2621	x1	80	440	530	510	2,70	mc. 0.017
110610-059	● cromato/chrome	x1	80	440	530	510	2,70	mc. 0.017

21 confezione puntali tondi d.22 neri black inner round flat caps d.22 package

code	finishing	q.kit	q.pack
137003-073	● nero/black	x4	200

18 logan-schienale traforato in plastica colorato a vista logan-perforated plastic back coloured at sight

code	finishing	q.kit	q.pack	a	b	kg.x1	vol.x1
132103-083	● nero/black	x1	10	390	500	0,82	mc. 0.088

19 logan-schienale pieno in plastica colorato a vista logan-full plastic back coloured at sight

code	finishing	q.kit	q.pack	a	b	kg.x1	vol.x1
132103-089	● nero/black	x1	10	390	500	0,82	mc. 0.088

06 logan-tappo per telaio e schienale inner caps-cover head d.22

code	finishing	q.kit	q.pack	kg.x1	vol.x1
131703-029	● nero/black	x2	20	0,025	mc. 0.001

07 logan-sedile in plastica colorato a vista logan-plastic seat coloured at sight

code	finishing	q.kit	q.pack	a	b	kg.x1	vol.x1
132203-082	● nero/black	x1	10	430	460	0,86	mc. 0.01

08 logan-sottosedile in plastica per telaio 4 gambe e slitta logan-outer plastic seat for four legs and slide

code	finishing	q.kit	q.pack	a	b	kg.x1	vol.x1
132203-080	● nero/black	x1	20	420	450	0,51	mc. 0.007

09 logan-sacchetto con viti + pf1 per 10 sedie - per sedile logan-screws + pf1 for 10 chairs (screw for fixed seat panel)

code	finishing	q.kit	q.pack
117000-022	● nero/black	x0.1	1

16 logan-coppia agganci laterali maschio + femmina cromati logan-chrome lateral hooks male + female

code	finishing	q.kit	q.pack	kg.x1	vol.x1
113410-100	● cromato/chrome	x1	100	0,13	mc. 0.0004

logan

4-legs/tablet accessories

main component sizes

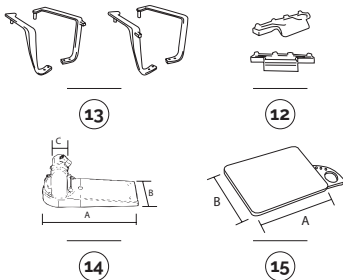

13 logan-coppia braccioli con aggancio portatavoletta in plastica

logan-pair of plastic arms right/left with writing tablet hook

code	finishing	q.kit	q.pack	kg.x1	vol.x1
131703-032	● nero/black	x1	10	left + right writing tablet hook	0,49 mc. 0,051
131703-033	● nero/black	x1	10	right + left writing tablet hook	0,49 mc. 0,051

11 logan-kit viti per 10 coppie braccioli

logan-kit screws for 10 pair arms

code	finishing	q.kit	q.pack	kg.x1	vol.x1
117000-025	● nero/black	x0.1	1		

12 logan-piastra di fissaggio per bracciolo

logan-fixing plate for arm

code	finishing	q.kit	q.pack	kg.x1	vol.x1
131703-034	● nero/black	x2	50	0,07	mc. 0,0013

14 spta-snodo tavoletta antipanico in alluminio lucido

spta-polished aluminium swivel safety mechanism for tablet

code	finishing	q.kit	q.pack	a	b	c	kg.x1	vol.x1
111701-900	● alluminio/aluminium destro/right	x1	10	180	66	15x15	0,365	mc. 0,001
111701-901	● alluminio/aluminium sinistro/left	x1	10	180	66	15x15	0,365	mc. 0,001

15 tlt3-tavoletta ambidestro con portabicchiere e portapenne

tlt3--writing tablet with cup holder and pen tray

code	finishing	q.kit	q.pack	a	b	kg.x1	vol.x1
134003-041	● nero/black	x1	10	410	300	1,05	mc. 0,036

TLT tablet TLT2 tablet TLT3 tablet BEAN tablet TL02 tablet SPT2 mechanism tablet SPTA mechanism antipanic



for writing tablet options, see page 242/243

4-legs/options

main component sizes

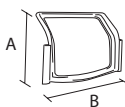

03

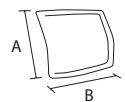

17



10



03 logan-telaio schienale in plastica portante

logan-outer back frame in plastic

code	finishing	q.kit	q.pack	a	b	kg.x1	vol.x1
132103-084	● nero/black	x1	10	390	500	0,58	mc. 0,088

17 logan-pannello schienale in plastica da tappezzare

logan-plastic panel back for upholstery

code	finishing	q.kit	q.pack	a	b	kg.x1	vol.x1
132103-086	● nero/black	x1	20	380	420	0,90	mc. 0,005

05 vite hilo tc + 4x14 zn nere

screw hilo tc + 4x14 zn black

code	finishing	q.kit
117803-120	● nero/black	x10

10 logan-coppia braccioli dx/sx in plastica

logan-pair of plastic arms right/left

code	finishing	q.kit	q.pack	kg.x1	vol.x1
131703-031	● nero/black	x1	10	0,43	mc. 0,051

and · 11 12 07 08 09

main component sizes

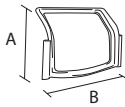

03

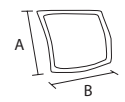

04



03 logan-telaio schienale in plastica portante

logan-outer back frame in plastic

code	finishing	q.kit	q.pack	a	b	kg.x1	vol.x1
132103-084	● nero/black	x1	10	390	500	0,58	mc. 0,088

04 logan-cornice schienale in plastica per rete

logan-open frame in plastic for mesh

code	finishing	q.kit	q.pack	a	b	kg.x1	vol.x1
132103-085	● nero/black	x1	20	380	420	0,30	mc. 0,005

and · 05 10 11 12 07 08 09



for all colour codes, see page 159

logan

4-legs for castors



logan-carrello portasedie con accessori
logan-trolley for chairs with accessories

code	finishing	q.kit
110803-344	● nero/black	x1

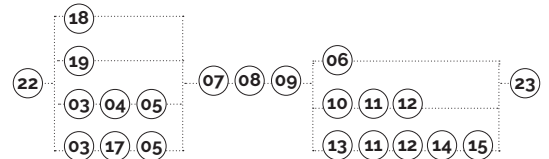

plastic colours

- nero/black
- grigio/gray ral 7040
- bianco/white ral 9003
- blu/blue ral 5014

main component sizes

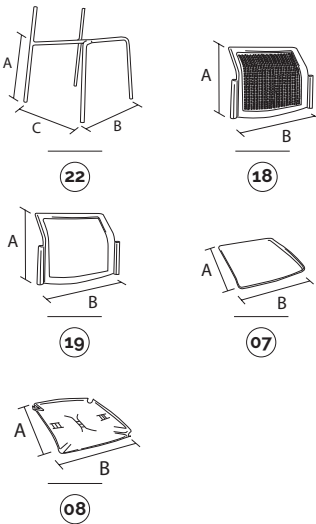

22 logan-telaio 4 gambe predisposto per 4 ruote + 4 tappi porta ruote
logan-fixed four legs frame issued for 4 wheels + 4 inner black caps for castors

code	finishing	q.kit	q.pack	a	b	c	kg.x1	vol.x1
110603-058	● nero/black	x1	80	440	470	510	2,70	mc. 0.017
110604-058	● grigio/grey ig2621	x1	80	440	470	510	2,70	mc. 0.017
110610-058	● cromato/chrome	x1	80	440	470	510	2,70	mc. 0.017

23 doppia ruota d.50 in desmopan con perno montato
twin wheel castor d.50 desmopan with pivot mounted

code	finishing	q.kit
134403-003	● nero/black	x4

18 logan-schienale traforato in plastica colorato a vista
logan-perforated plastic back coloured at sight

code	finishing	q.kit	q.pack	a	b	kg.x1	vol.x1
132103-083	● nero/black	x1	10	390	500	0,82	mc. 0.088

19 logan-schienale pieno in plastica colorato a vista
logan-full plastic back coloured at sight

code	finishing	q.kit	q.pack	a	b	kg.x1	vol.x1
132103-089	● nero/black	x1	10	390	500	0,82	mc. 0.088

06 logan-tappo per telaio e schienale
inner caps-cover head d.22

code	finishing	q.kit	q.pack	kg.x1	vol.x1
131703-029	● nero/black	x2	20	0,025	mc. 0.001

07 logan-sedile in plastica colorato a vista
logan-plastic seat coloured at sight

code	finishing	q.kit	q.pack	a	b	kg.x1	vol.x1
132203-082	● nero/black	x1	10	430	460	0,86	mc. 0.01

08 logan-sottosedile in plastica per telaio 4 gambe e slitta
logan-outer plastic seat for four legs and slide

code	finishing	q.kit	q.pack	a	b	kg.x1	vol.x1
132203-080	● nero/black	x1	20	420	450	0,51	mc. 0.007

09 logan-sacchetto con viti + pf1 per 10 sedie - per sedile
logan-screws + pf1 for 10 chairs (screw for fixed seat panel)

code	finishing	q.kit	q.pack
117000-022	● nero/black	x0.1	1

logan

4-legs for castors/tablet accessories

main component sizes

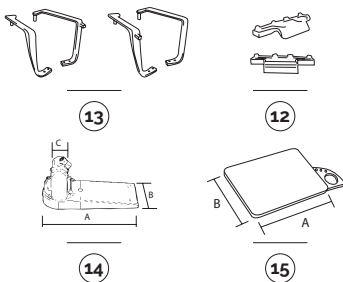

13 logan-coppia braccioli con aggancio portatavoletta in plastica

logan-pair of plastic arms right/left with writing tablet hook

code	finishing	q.kit	q.pack	kg.x1	vol.x1
131703-032	● nero/black	x1	10	left + right writing tablet hook	0,49 mc. 0,051
131703-033	● nero/black	x1	10	right + left writing tablet hook	0,49 mc. 0,051

11 logan-kit viti per 10 coppie braccioli

logan-kit screws for 10 pair arms

code	finishing	q.kit	q.pack	kg.x1	vol.x1
117000-025	● nero/black	x0.1	1		

12 logan-piastra di fissaggio per bracciolo

logan-fixing plate for arm

code	finishing	q.kit	q.pack	kg.x1	vol.x1
131703-034	● nero/black	x2	50	0,07	mc. 0,0013

14 spta-snodo tavoletta antipanico in alluminio lucido

spta-polished aluminium swivel safety mechanism for tablet

code	finishing	q.kit	q.pack	a	b	c	kg.x1	vol.x1
111701-900	● alluminio/aluminium destro/right	x1	10	180	66	15x15	0,365	mc. 0,001
111701-901	● alluminio/aluminium sinistro/left	x1	10	180	66	15x15	0,365	mc. 0,001

15 tlt3-tavoletta ambidestro con portabicchiere e portapenne

tlt3--writing tablet with cup holder and pen tray

code	finishing	q.kit	q.pack	a	b	kg.x1	vol.x1
134003-041	● nero/black	x1	10	410	300	1,05	mc. 0,036

TLT tablet TLT2 tablet TLT3 tablet BEAN tablet TL02 tablet SPT2 mechanism tablet SPTA mechanism antipanic



for writing tablet options, see page 242/243

4-legs for castors/options

main component sizes

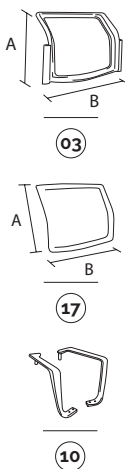

03 logan-telaio schienale in plastica portante

logan-outer back frame in plastic

code	finishing	q.kit	q.pack	a	b	kg.x1	vol.x1
132103-084	● nero/black	x1	10	390	500	0,58	mc. 0,088

17 logan-pannello schienale in plastica da tappezzare

logan-plastic panel back for upholstery

code	finishing	q.kit	q.pack	a	b	kg.x1	vol.x1
132103-086	● nero/black	x1	20	380	420	0,90	mc. 0,005

05 vite hilo tc + 4x14 zn nere

screw hilo tc + 4x14 zn black

code	finishing	q.kit
117803-120	● nero/black	x10

10 logan-coppia braccioli dx/sx in plastica

logan-pair of plastic arms right/left

code	finishing	q.kit	q.pack	kg.x1	vol.x1
131703-031	● nero/black	x1	10	0,43	mc. 0,051

and · 11 12 07 08 09

main component sizes

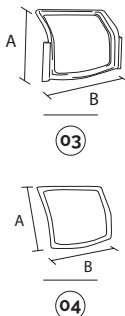

03 logan-telaio schienale in plastica portante

logan-outer back frame in plastic

code	finishing	q.kit	q.pack	a	b	kg.x1	vol.x1
132103-084	● nero/black	x1	10	390	500	0,58	mc. 0,088

04 logan-cornice schienale in plastica per rete

logan-open frame in plastic for mesh

code	finishing	q.kit	q.pack	a	b	kg.x1	vol.x1
132103-085	● nero/black	x1	20	380	420	0,30	mc. 0,005

and · 05 10 11 12 07 08 09



for all colour codes, see page 159

logan

swivel

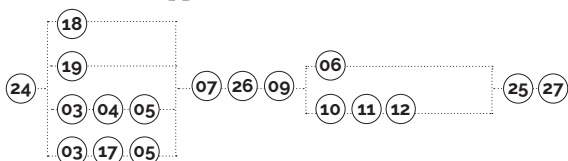
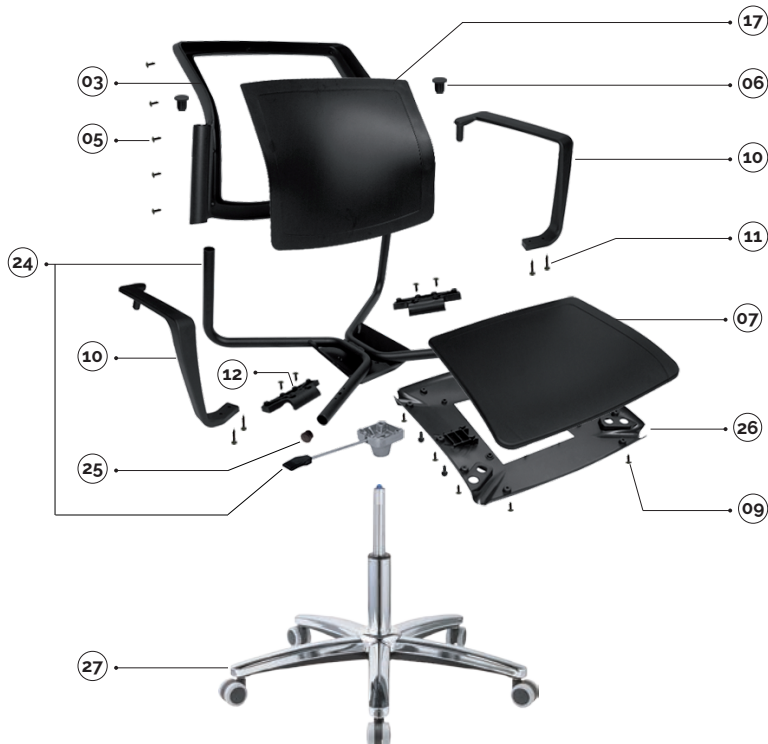

plastic colours

- nero/black
- grigio/gray ral 7040
- bianco/white ral 9003
- blu/blue ral 5014

main component sizes

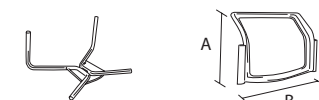

24



03

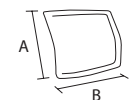

17

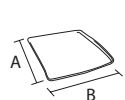

07

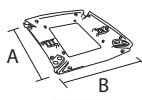

26



10



12

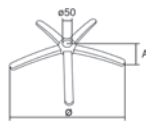

27

24 logan-telaio per girevole comando a gas senza tappi
logan-swivel frame with gas lever without caps

code	finishing	q.kit	q.pack	kg.x1	vol.x1
110903-024	● nero/black	x1	100	2,55	mc. 0,046

25 tc22-tappo copritesta alettato d.22 nero
tc22-inner caps-cover head d.22 black

code	finishing	q.kit
134103-220	● nero/black	x2

03 logan-telaio schienale in plastica portante
logan-outer back frame in plastic

code	finishing	q.kit	q.pack	a	b	kg.x1	vol.x1
132103-084	● nero/black	x1	10	390	500	0,58	mc. 0,088

17 logan-pannello schienale in plastica da tappezzeria
logan-plastic panel back for upholstery

code	finishing	q.kit	q.pack	a	b	kg.x1	vol.x1
132103-086	● nero/black	x1	20	380	420	0,90	mc. 0,005

05 vite hilo tc + 4x14 zn nere
screw hilo tc+ 4x14 zn black

code	finishing	q.kit
117803-120	● nero/black	x10

07 logan-sedile in plastica colorato a vista
logan-plastic seat coloured at sight

code	finishing	q.kit	q.pack	a	b	kg.x1	vol.x1
132203-082	● nero/black	x1	10	430	460	0,86	mc. 0,01

26 logan-sottosedile esterno in plastica per telaio panca e girevole
logan-outer plastic seat for swivel and bench

code	finishing	q.kit	q.pack	a	b	kg.x1	vol.x1
132203-081	● nero/black	x1	20	420	450	0,47	mc. 0,007

09 logan-sacchetto con viti + pf1 per 10 sedie - per sedile
logan-screws + pf1 for 10 chairs (screw for fixed seat panel)

code	finishing	q.kit	q.pack
117000-022	● nero/black	x0.1	1

10 logan-coppia braccioli dx/sx in plastica
logan-pair of plastic arms right/left

code	finishing	q.kit	q.pack	kg.x1	vol.x1
131703-031	● nero/black	x1	10	0,43	mc. 0,051

11 logan-kit viti per 10 coppie braccioli
logan-kit screws for 10 pair arms

code	finishing	q.kit	q.pack
117000-025	● nero/black	x0.1	1

12 logan-piastra di fissaggio per bracciolo
logan-fixing plate for arm

code	finishing	q.kit	q.pack	kg.x1	vol.x1
131703-034	● nero/black	x2	50	0,07	mc. 0,0013

27 b40 base in metallo d.640 con coprisaldatura
b40 metal base d.640 with cover welding

code	finishing	q.kit	q.pack	a	o	kg.x1	vol.x1
110210-027	● cromato/chrome	x1	5	60	640	2,85	mc. 0,014

logan

swivel/options

main component sizes

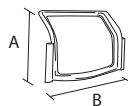

03

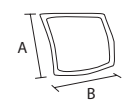

04



03 logan-telaio schienale in plastica portante
logan-outer back frame in plastic

code	finishing	q.kit	q.pack	a	b	kg.x1	vol.x1
132103-084	● nero/black	x1	10	390	500	0,58	mc. 0,088

04 logan-cornice schienale in plastica per rete
logan-open frame in plastic for mesh

code	finishing	q.kit	q.pack	a	b	kg.x1	vol.x1
132103-085	● nero/black	x1	20	380	420	0,30	mc. 0,005

and - 05 10 11 12 07 26 09

main component sizes

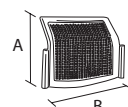

18

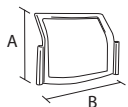

19



18 logan-schienale traforato in plastica colorato a vista
logan-perforated plastic back coloured at sight

code	finishing	q.kit	q.pack	a	b	kg.x1	vol.x1
132103-083	● nero/black	x1	10	390	500	0,82	mc. 0,088

19 logan-schienale pieno in plastica colorato a vista
logan-full plastic back coloured at sight

code	finishing	q.kit	q.pack	a	b	kg.x1	vol.x1
132103-089	● nero/black	x1	10	390	500	0,82	mc. 0,088

and - 10 11 12 07 26 09



for all colour codes, see page 159

logan

bench



plastic colours

- nero/black
- grigio/gray ral 7040
- bianco/white ral 9003
- blu/blue ral 5014

main component sizes

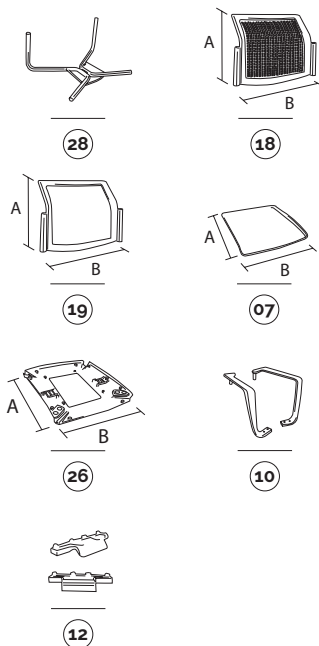

28 logan-telaio per panca senza tappi
logan-bench frame caps excluded

code	finishing	q.kit	q.pack	kg.x1	vol.x1
110703-024	● nero/black	x1	100	2,20	mc. 0,046

25 tc22-tappo copritesta alettato d.22 nero
tc22-inner caps-cover head d.22 black

code	finishing	q.kit
134103-220	● nero/black	x2

18 logan-schienale traforato in plastica colorato a vista
logan-perforated plastic back coloured at sight

code	finishing	q.kit	q.pack	a	b	kg.x1	vol.x1
132103-083	● nero/black	x1	10	390	500	0,82	mc. 0,088

19 logan-schienale pieno in plastica colorato a vista
logan-full plastic back coloured at sight

code	finishing	q.kit	q.pack	a	b	kg.x1	vol.x1
132103-089	● nero/black	x1	10	390	500	0,82	mc. 0,088

06 logan-tappo per telaio e schienale
inner caps-cover head d.22

code	finishing	q.kit	q.pack	kg.x1	vol.x1
131703-029	● nero/black	x2	20	0,025	mc. 0,001

07 logan-sedile in plastica colorato a vista
logan-plastic seat coloured at sight

code	finishing	q.kit	q.pack	a	b	kg.x1	vol.x1
132203-082	● nero/black	x1	10	430	460	0,86	mc. 0,01

26 logan-sottosedile esterno in plastica per telaio panca e girevole
logan-outer plastic seat for swivel and bench

code	finishing	q.kit	q.pack	a	b	kg.x1	vol.x1
132203-081	● nero/black	x1	20	420	450	0,47	mc. 0,007

09 logan-sacchetto con viti + pf1 per 10 sedile - per sedile
logan-screws + pf1 for 10 chairs (screw for fixed seat panel)

code	finishing	q.kit	q.pack
117000-022	● nero/black	x0.1	1

10 logan-coppia braccioli dx/sx in plastica
logan-pair of plastic arms right/left

code	finishing	q.kit	q.pack	kg.x1	vol.x1
131703-031	● nero/black	x1	10	0,43	mc. 0,051

11 logan-kit viti per 10 coppie braccioli
logan-kit screws for 10 pair arms

code	finishing	q.kit	q.pack
117000-025	● nero/black	x0.1	1

12 logan-piastra di fissaggio per bracciolo
logan-fixing plate for arm

code	finishing	q.kit	q.pack	kg.x1	vol.x1
131703-034	● nero/black	x2	50	0,07	mc. 0,0013

for the bench components, see page 249

OPTIONAL
bench
connector

E-USB **NEW**
bench plug

JIM **NEW**
bench leg

APOLL
bench arm

90GM
bench leg

90GF
bench leg

100GM
bench leg

200GM
bench leg

PIONEER
bench arm

CUT
bench leg

SLIM
bench leg

CUT
bench arm

SLIM
bench arm



plastic

metal

aluminium

optionals

logan

bench/tablet accessories

main component sizes

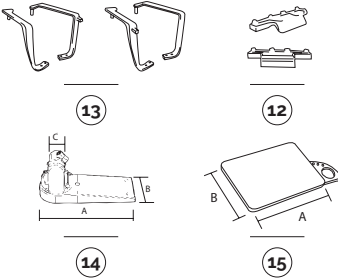

13 logan-coppia braccioli con aggancio portatavoletta in plastica logan-pair of plastic arms right/left with writing tablet hook

code	finishing	q.kit	q.pack	kg.x1	vol.x1
131703-032	● nero/black	x1	10	left + right writing tablet hook	0,49 mc. 0,051
131703-033	● nero/black	x1	10	right + left writing tablet hook	0,49 mc. 0,051

11 logan-kit viti per 10 coppie braccioli logan-kit screws for 10 pair arms

code	finishing	q.kit	q.pack	kg.x1	vol.x1
117000-025	● nero/black	x0.1	1		

12 logan-piastra di fissaggio per bracciolo logan-fixing plate for arm

code	finishing	q.kit	q.pack	kg.x1	vol.x1
131703-034	● nero/black	x2	50	0,07	mc. 0,0013

14 spta-snodo tavoletta antipanico in alluminio lucido spta-polished aluminium swivel safety mechanism for tablet

code	finishing	q.kit	q.pack	a	b	c	kg.x1	vol.x1
111701-900	● alluminio/aluminium destro/right	x1	10	180	66	15x15	0,365	mc. 0,001
111701-901	● alluminio/aluminium sinistro/left	x1	10	180	66	15x15	0,365	mc. 0,001

15 tlt3-tavoletta ambidestro con portabicchiere e portapenne tlt3--writing tablet with cup holder and pen tray

code	finishing	q.kit	q.pack	a	b	kg.x1	vol.x1
134003-041	● nero/black	x1	10	410	300	1,05	mc. 0,036

TLT tablet TLT2 tablet TLT3 tablet BEAN tablet TL02 tablet SPT2 mechanism tablet SPTA mechanism antipanic



for writing tablet options, see page 242/243

bench/options

main component sizes

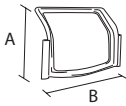

03

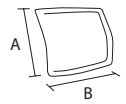

17



10



03 logan-telaio schienale in plastica portante logan-outer back frame in plastic

code	finishing	q.kit	q.pack	a	b	kg.x1	vol.x1
132103-084	● nero/black	x1	10	390	500	0,58	mc. 0,088

17 logan-pannello schienale in plastica da tappezzare logan-plastic panel back for upholstery

code	finishing	q.kit	q.pack	a	b	kg.x1	vol.x1
132103-086	● nero/black	x1	20	380	420	0,90	mc. 0,005

05 vite hilo tc + 4x14 zn nere screw hilo tc + 4x14 zn black

code	finishing	q.kit
117803-120	● nero/black	x10

10 logan-coppia braccioli dx/sx in plastica logan-pair of plastic arms right/left

code	finishing	q.kit	q.pack	kg.x1	vol.x1
131703-031	● nero/black	x1	10	0,43	mc. 0,051

and · 11 12 07 26 09

main component sizes

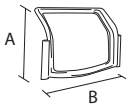

03

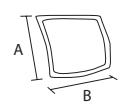

04



03 logan-telaio schienale in plastica portante logan-outer back frame in plastic

code	finishing	q.kit	q.pack	a	b	kg.x1	vol.x1
132103-084	● nero/black	x1	10	390	500	0,58	mc. 0,088

04 logan-cornice schienale in plastica per rete logan-open frame in plastic for mesh

code	finishing	q.kit	q.pack	a	b	kg.x1	vol.x1
132103-085	● nero/black	x1	20	380	420	0,30	mc. 0,005

and · 05 10 11 12 07 26 09



for all colour codes, see page 159

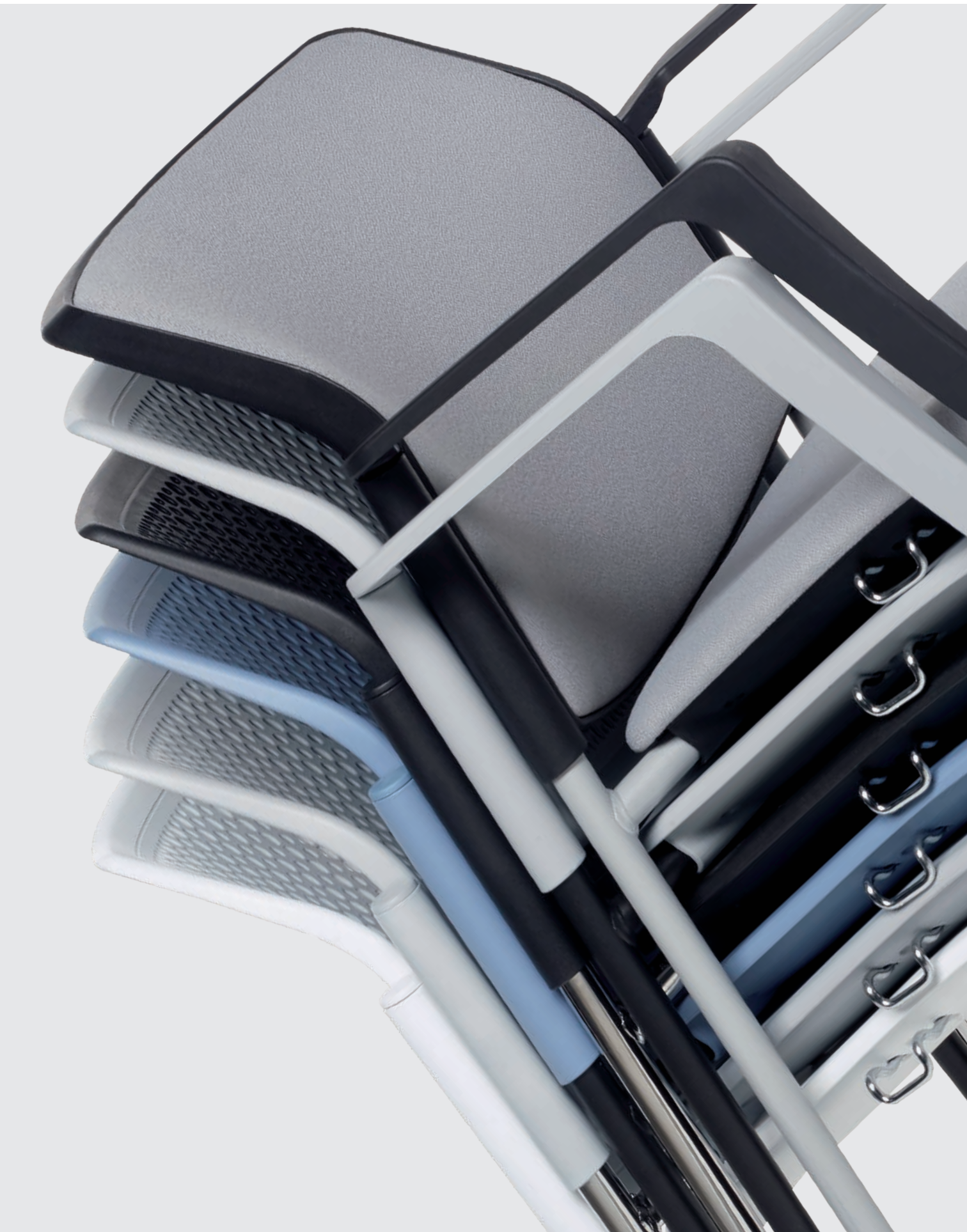



plastic colour codes



18 schienale traforato in plastica
perforated plastic backrest

- **132103-083** nero/black
- **132104-083** grigio/gray ral 7040
- **132105-083** bianco/white ral 9003
- **132115-083** blu/blue ral 5014



19 schienale pieno in plastica
full plastic backrest

- **132103-089** nero/black
- **132104-089** grigio/gray ral 7040
- **132105-089** bianco/white ral 9003
- **132115-089** blu/blue ral 5014



06 tappo in plastica
plastic inner cap

- **131703-029** nero/black
- **131704-029** grigio/gray ral 7040
- **131705-029** bianco/white ral 9003
- **131715-029** blu/blue ral 5014

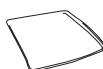

07 sedile in plastica
plastic seat

- **132203-082** nero/black
- **132204-082** grigio/gray ral 7040
- **132205-082** bianco/white ral 9003
- **132215-082** blu/blue ral 5014



08 sottosedile in plastica
outer plastic seat

- **132203-080** nero/black
- **132204-080** grigio/gray ral 7040
- **132205-080** bianco/white ral 9003
- **132215-080** blu/blue ral 5014



26 sottosedile in pl. per girevole e panca
outer plastic seat for swivel and bench

- **132203-081** nero/black
- **132204-081** grigio/gray ral 7040
- **132205-081** bianco/white ral 9003
- **132215-081** blu/blue ral 5014



10 braccioli in plastica
plastic armrests

- **131703-031** nero/black
- **131704-031** grigio/gray ral 7040
- **131705-031** bianco/white ral 9003
- **131715-031** blu/blue ral 5014

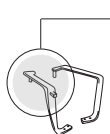

aggancio porta tavoletta DESTRO
RIGHT writing tablet hook

13 braccioli in plastica per tavoletta
plastic armrests with writing tablet hook

- **131703-032** L+R writ. tab hook nero/black
- **131704-032** L+R writ. tab hook grigio/gray ral 7040
- **131705-032** L+R writ. tab hook bianco/white ral 9003
- **131715-032** L+R writ. tab hook blu/blue ral 5014

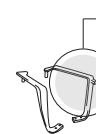

aggancio porta tavoletta SINISTRO
LEFT writing tablet hook

13 braccioli in plastica per tavoletta
plastic armrests with writing tablet hook

- **131703-033** R+L writ. tab hook nero/black
- **131704-033** R+L writ. tab hook grigio/gray ral 7040
- **131705-033** R+L writ. tab hook bianco/white ral 9003
- **131715-033** R+L writ. tab hook blu/blue ral 5014

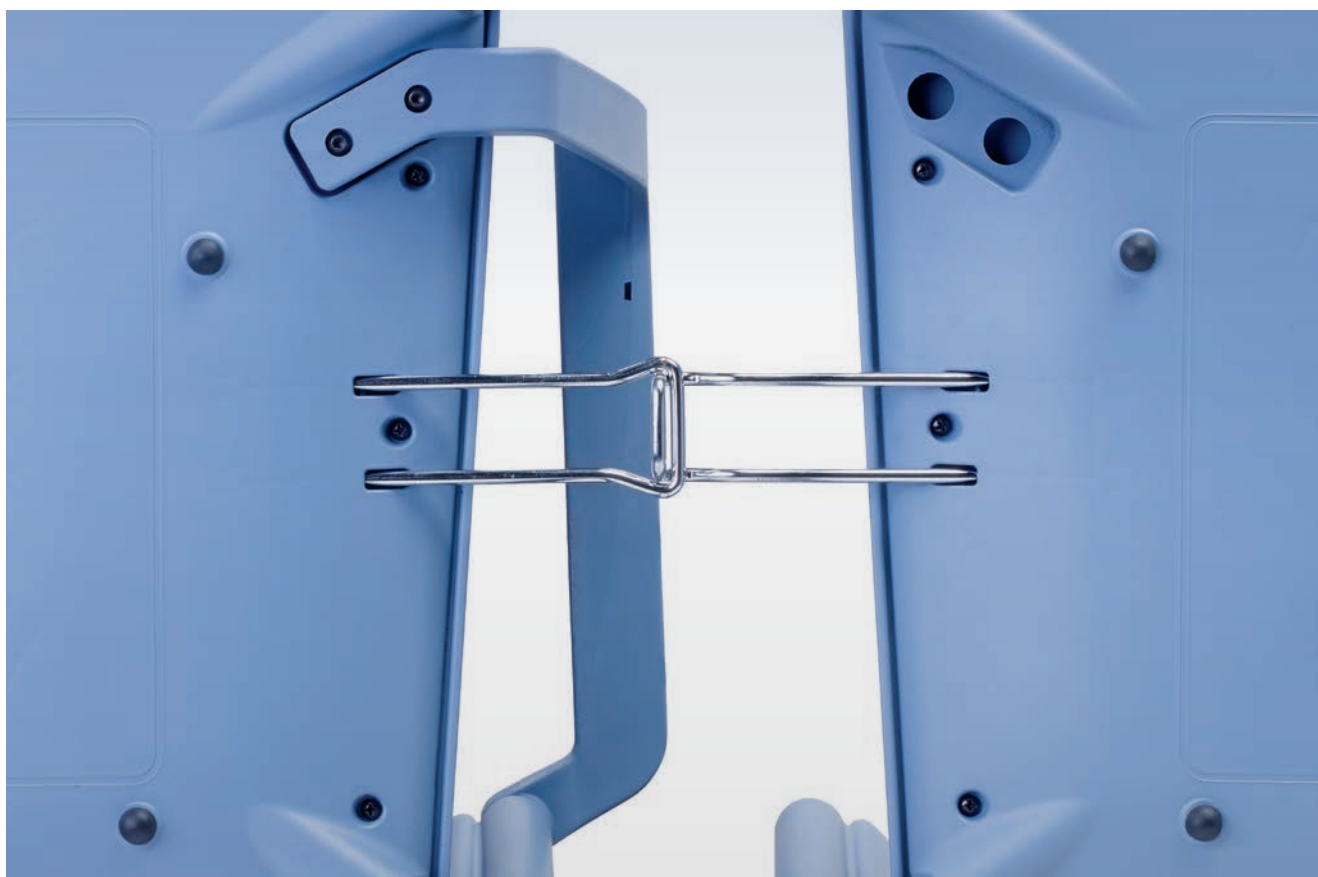





duetto



duetto



slide
slide w/armrests
stool

4 legs
4 legs w/armrest

swivel

bench



EN 16139

tools



configurator



brochure



certification



video

duetto showing

features



trolley available



Duetto: l'innovativo sistema di scocche da incastro.

Massima versatilità di composizione di schienale e sedile, con la possibilità di mixarne i colori, assoluta funzionalità e design minimale, grazie all'assenza di accessori per il montaggio. Opzionabile su tutti i telai il pannello in legno multistrato da tappezzare. Disponibile anche la versione sgabello in due altezze: 730 mm e 630 mm.

Plus:

- possibilità di avere due pezzi in uno, mixandone i colori, grazie all'innovativo sistema da incastro tra scocche;
- design minimale e sottile;
- estrema versatilità di colori alla moda;
- facile da sollevare grazie al foro centrale;
- comodamente impliabile nella versione slitta e 4 gambe.

Duetto si adatta agli ambienti Home e Contract.

Duetto: the innovative system of interlocking seat shell components.

Maximum versatility in the composition of the backrest and seat, with the possibility of mixing colours. Outstanding functionality and minimalist design, requiring no accessories for assembly. The plywood panel to be upholstered is optional on all frame types. Stool version available in two heights: 730 mm and 630 mm.

Advantages:

- the innovative interlocking seat shell components mean two differently-coloured pieces can be combined together;
- minimalist slimline design;
- extreme versatility with range of trendy colours;
- easy to lift thanks to the central hole;
- easy stackability in both the slide and 4-legs versions.

Duetto adapts to Home and Contract environments.

duetto

slide



CERTIFIED BY
CATAS



plastic colours

- blu/blue ral 5014
- nero/black
- grigio/gray ral 7003
- bianco/white 218
- rosso/red 527

main component sizes

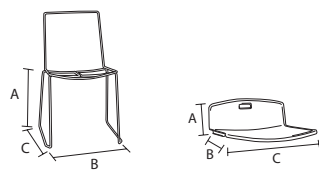

01

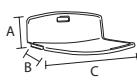

07

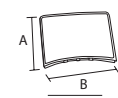

08

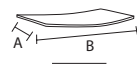

09

optionals



02



03



04



05



06

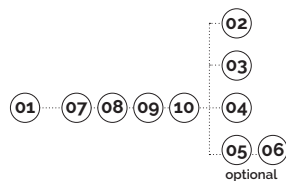

01 duetto-telaio a slitta in tondino d.11
duetto-slide wire frame d.11

code	finishing	q.kit	q.pack	a	b	c	kg.x1	vol.x1
113410-046	● cromato/chrome	x1	100	450	510	480	4,40	mc. 0.02

02 confezione di basi a pinza antirrotazione per tondino colore neutro
neutral clips base for wire d.11 package

code	finishing	q.kit	q.pack
137006-070	○ neutro/neutral	x4	200

03 base piana a pinza doppia
double flat clip base

code	finishing	q.kit
134006-021	○ neutro/neutral	x4

04 btf-kit piedini
btf-kit feet

code	finishing	q.kit	q.pack	kg.x1
134306-001	○ neutro/neutral	x1	100	0,05

05 btf-kit piedini con ganci
btf-kit feet with hooks

code	finishing	q.kit	q.pack	kg.x1
134306-002	○ neutro/neutral	x1	100	0,06

06 pptf-tappo per fissaggio pavimento
pptf-cap for fixing to the floor

code	finishing	q.kit	q.pack	kg.x1
134306-003	○ neutro/neutral	x2	100	0,03

07 duetto-sedile a vista in plastica colorato + pf1 neutri
duetto-plastic seat colored + pf1

code	finishing	q.kit	q.pack	a	b	c	kg.x1	vol.x1
132203-022	● nero/black	x1	10	180	390	430	0,80	mc. 0.09

08 duetto-schienale a vista in plastica colorato
duetto-plastic back colored

code	finishing	q.kit	q.pack	a	b	kg.x1	vol.x1
132103-022	● nero/black	x1	20	280	395	0,40	mc. 0.03

09 duetto-pannello sedile multistrato con 6 borchie m6
duetto-seat panel with 6 upholstery nail m6

code	finishing	q.kit	q.pack	a	b	kg.x1	vol.x1
122207-019	● faggio/plywood	x1	20	395	410	0,74	mc. 0.003

10 duetto-vite tbl combi m6x8 dentell. zincata bianca (vite per fissaggio pannello)
duetto-screw tbl combi m6x12 white zinc (screw for fix panel)

code	finishing	q.kit
117711-207	○ zincata bianca/white zinc	x6

for all colour codes, see page 171

duetto

slide w/armrests

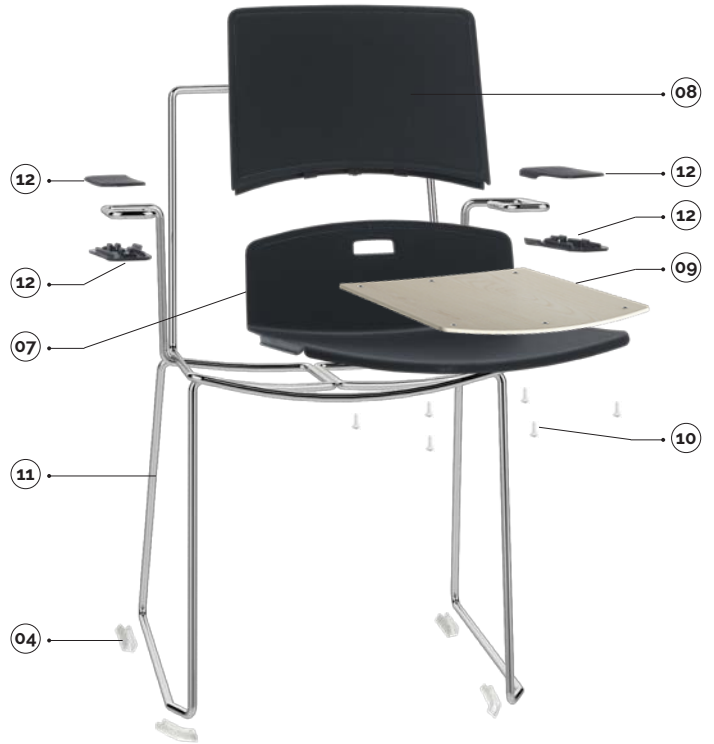

plastic colours

- blu/blue ral 5014
- nero/black
- grigio/gray ral 7003
- bianco/white 218
- rosso/red 527

main component sizes

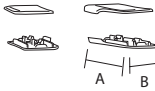
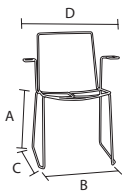

11

12

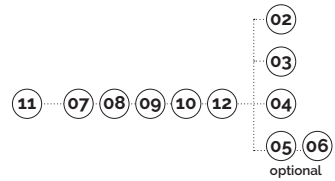

11 duetto-telaio a slitta in tondino d.11 con braccioli
duetto-slide wire frame d.11 with arms

code	finishing	q.kit	q.pack	a	b	c	d	kg.x1	vol.x1
113410-047	● cromato/chrome	x1	50	450	510	480	650	5,40	mc. 0.04

12 duetto-coppia braccioli in plastica colorata
duetto-pair colored plastic arms

code	finishing	q.kit	q.pack	a	b	kg.x1	vol.x1
131703-075	● nero/black	x1	20	180	70	0,20	mc. 0.009

for the components below, see page 164

02 03 04 05 06 07 08 09 10



for all colour codes, see page 171



duetto-carrello portasedie con accessori nero
duetto-trolley for chairs with accessories black

code	finishing	q.kit
110803-373	● nero/black	x1

duetto

stool

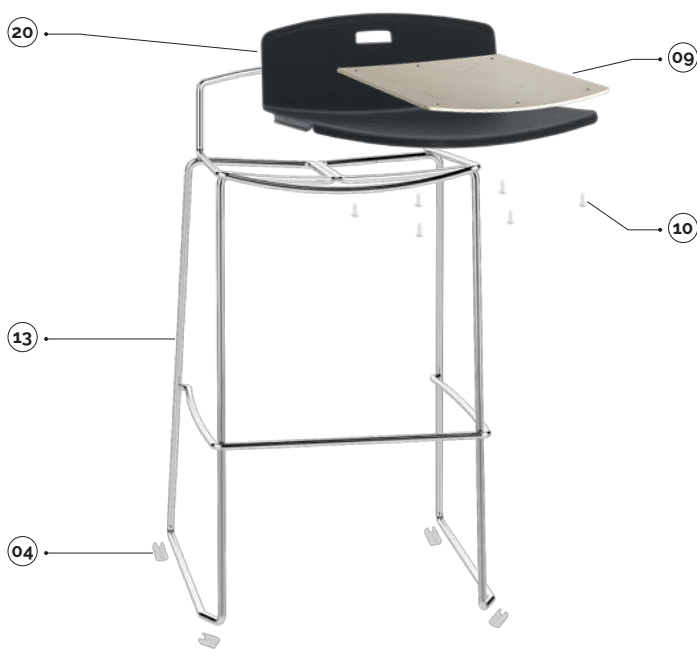

plastic colours

- blu/blue ral 5014
- nero/black
- grigio/gray ral 7003
- bianco/white 218
- rosso/red 527

main component sizes

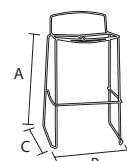

optipnats

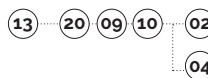

h.630	13 duetto-sgabello alto h.630 in tondino d.11 duetto-wire high bar stool h.630 d.11	code	finishing	q.kit	q.pack	a	b	c	kg.x1	vol.x1
	113410-048	● cromato/chrome		x1	50	630	525	500	5,70	mc. 0.04
h.730	13 duetto-sgabello alto h.730 in tondino d.11 duetto-wire high bar stool h.730 d.11	code	finishing	q.kit	q.pack	a	b	c	kg.x1	vol.x1
	113410-049	● cromato/chrome		x1	50	730	525	500	6,00	mc. 0.04
	02 confezione di basi a pinza antirrotazione per tondino colore neutro neutral clips base for wire d.11 package	code	finishing	q.kit	q.pack					
	137006-070	○ neutro/neutral		x4	200					
	04 btf-kit piedini btf-kit feet	code	finishing	q.kit	q.pack				kg.x1	
	134306-001	○ neutro/neutral		x1	100				0,05	
	20 duetto-sedile a vista in plastica colorato • pf1 neutri duetto-plastic seat colored • pf1	code	finishing	q.kit	q.pack	a	b	c	kg.x1	vol.x1
	132203-028	● nero/black		x1	10	180	390	430	0,80	mc. 0.09
	09 duetto-pannello sedile multistrato con 6 borchie m6 duetto-seat panel with 6 upholstery nail m6	code	finishing	q.kit	q.pack	a	b		kg.x1	vol.x1
	122207-019	● faggio/plywood		x1	20	395	410		0,74	mc. 0.003
	10 duetto-vite tbl combi m6x8 dentell. zincata bianca (vite per fissaggio pannello) duetto-screw tbl combi m6x12 white zinc (screw for fix panel)	code	finishing	q.kit						
	117711-207	○ zincata bianca/white zinc		x6						



for all colour codes, see page 171

duetto

4-legs

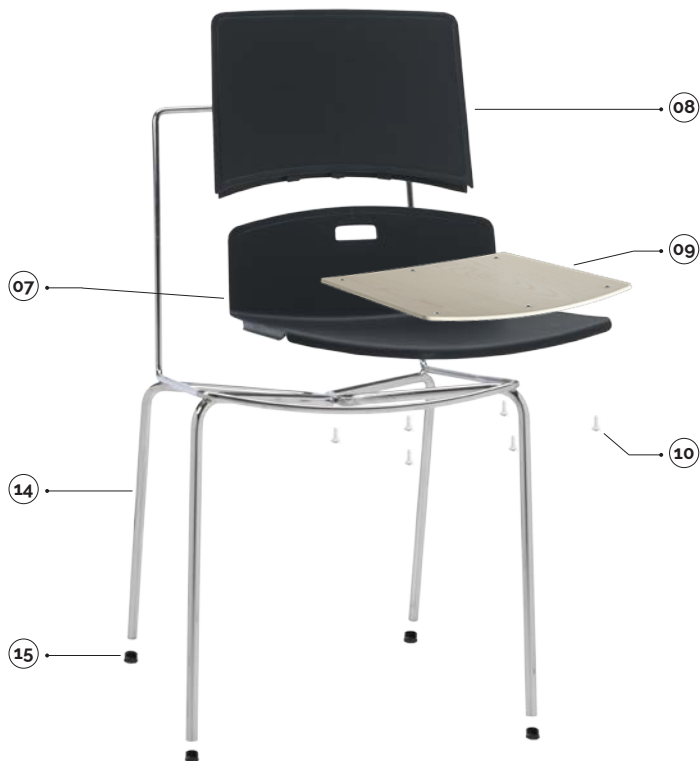

plastic colours

- blu/blue ral 5014
- nero/black
- grigio/gray ral 7003
- bianco/white 218
- rosso/red 527

main component sizes

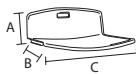
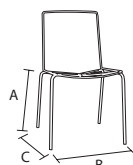

14 07 08 09 10 15

14 duetto-telaio 4 gambe in tubo d.16 senza tappi
duetto-4 legs frames d.16 without caps

code	finishing	q.kit	q.pack	a	b	c	kg.x1	vol.x1
112710-036	● cromato/chrome	x1	100	450	510	480	3,70	mc. 0.02
112703-036	● nero/black	x1	100	450	510	480	3,70	mc. 0.02
112704-036	● grigio/grey ikea 4	x1	100	450	510	480	3,70	mc. 0.02
112705-036	○ avorio/ivory ral1013	x1	100	450	510	480	3,70	mc. 0.02

15 puntale alettato tondo d.16 nero
inner cap for legs d.16 black

code	finishing	q.kit
134203-160	● nero/black	x4

07 duetto-sedile a vista in plastica colorato + pf1 neutri
duetto-plastic seat colored + pf1

code	finishing	q.kit	q.pack	a	b	c	kg.x1	vol.x1
132203-022	● nero/black	x1	10	180	390	430	0,80	mc. 0.09

08 duetto-schienale a vista in plastica colorato
duetto-plastic back colored

code	finishing	q.kit	q.pack	a	b	kg.x1	vol.x1
132103-022	● nero/black	x1	20	280	395	0,40	mc. 0.03

09 duetto-pannello sedile multistrato con 6 borchie m6
duetto-seat panel with 6 upholstery nail m6

code	finishing	q.kit	q.pack	a	b	kg.x1	vol.x1
122207-019	● faggio/plywood	x1	20	395	410	0,74	mc. 0.003

10 duetto-vite tbl combi m6x8 dentell. zincata bianca (vite per fissaggio pannello)
duetto-screw tbl combi m6x12 white zinc (screw for fix panel)

code	finishing	q.kit
117711-207	○ zincata bianca/white zinc	x6



for all colour codes, see page 171



duetto-carrello portasedie con accessori nero
duetto-trolley for chairs with accessories black

code	finishing	q.kit
110803-373	● nero/black	x1

duetto

4-legs w/armrests

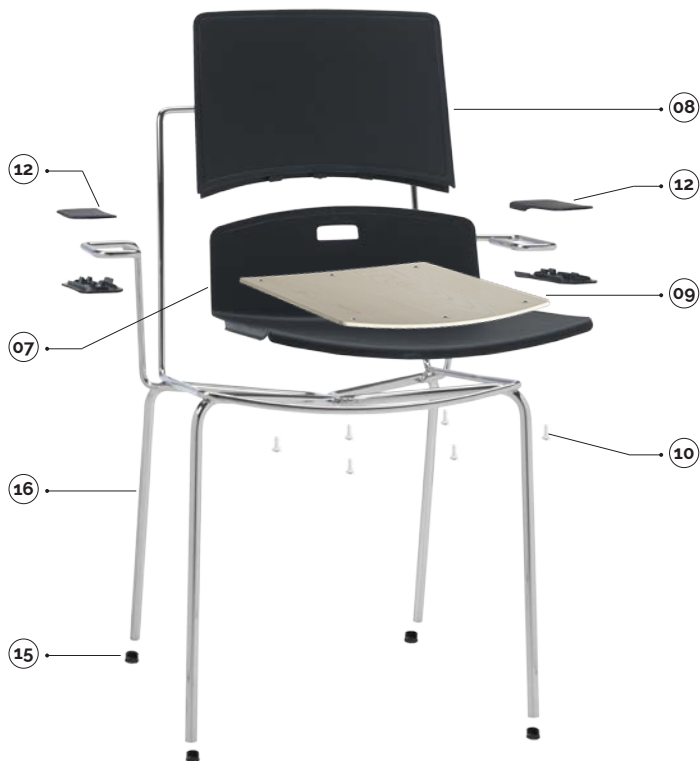

plastic colours

- blu/blue ral 5014
- nero/black
- grigio/gray ral 7003
- bianco/white 218
- rosso/red 527

main component sizes

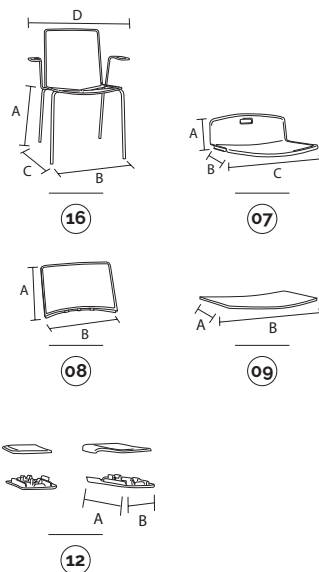

16 07 08 09 10 12 15

16 duetto-telaio 4 gambe d.16 con braccioli senza tappi
duetto-4 legs frame d.16 with arm and without caps

code	finishing	q.kit	q.pack	a	b	c	d	kg.x1	vol.x1
112710-035	● cromato/chrome	x1	50	450	510	480	650	4,70	mc. 0.04
112703-035	● nero/black	x1	50	450	510	480	650	4,70	mc. 0.04
112704-035	● grigio/grey ikea 4	x1	50	450	510	480	650	4,70	mc. 0.04
112705-035	○ avorio/ivory ral1013	x1	50	450	510	480	650	4,70	mc. 0.04

15 puntale alettato tondo d.16 nero
inner cap for legs d.16 black

code	finishing	q.kit
134203-160	● nero/black	x4

07 duetto-sedile a vista in plastica colorato + pf1 neutri
duetto-plastic seat colored + pf1

code	finishing	q.kit	q.pack	a	b	c	kg.x1	vol.x1
132203-022	● nero/black	x1	10	180	390	430	0,80	mc. 0.09

08 duetto-schienale a vista in plastica colorato
duetto-plastic back colored

code	finishing	q.kit	q.pack	a	b	kg.x1	vol.x1
132103-022	● nero/black	x1	20	280	395	0,40	mc. 0.03

09 duetto-pannello sedile multistrato con 6 borchie m6
duetto-seat panel with 6 upholstery nail m6

code	finishing	q.kit	q.pack	a	b	kg.x1	vol.x1
122207-019	● faggio/plywood	x1	20	395	410	0,74	mc. 0.003

10 duetto-vite tbl combi m6x8 dentell. zincata bianca (vite per fissaggio pannello)
duetto-screw tbl combi m6x12 white zinc (screw for fix panel)

code	finishing	q.kit
117711-207	○ zincata bianca/white zinc	x6

12 duetto-coppia braccioli in plastica colorata
duetto-pair colored plastic arms

code	finishing	q.kit	q.pack	a	b	kg.x1	vol.x1
131703-075	● nero/black	x1	20	180	70	0,20	mc. 0.009



for all colour codes, see page 171

duetto-carrello portasedie con accessori nero
duetto-trolley for chairs with accessories black

code	finishing	q.kit
110803-373	● nero/black	x1



duetto

swivel



17 07 08 09 10 18
optional

plastic colours

- blu/blue ral 5014
- nero/black
- grigio/gray ral 7003
- bianco/white 218
- rosso/red 527

main component sizes

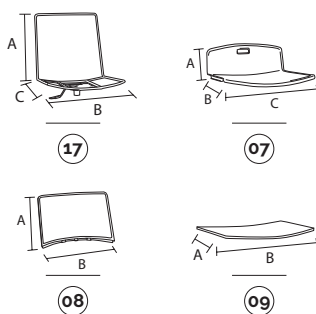

optional

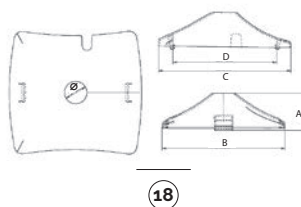

17 duetto-supporto girevole a gas per scocca duetto duetto-swivel frame for duetto shell

code	finishing	q.kit	q.pack	a	b	c	kg.x1	vol.x1
110910-017	● cromato/chrome	x1	100	400	430	390	4,00	mc. 0,02

07 duetto-sedile a vista in plastica colorato + pf1 neutri duetto-plastic seat colored + pf1 neutrals

code	finishing	q.kit	q.pack	a	b	c	kg.x1	vol.x1
132203-022	● nero/black	x1	10	180	390	430	0,80	mc. 0,09

08 duetto-schienale a vista in plastica colorato duetto-plastic back colored

code	finishing	q.kit	q.pack	a	b	kg.x1	vol.x1
132103-022	● nero/black	x1	20	280	395	0,40	mc. 0,03

09 duetto-pannello sedile multistrato con 6 borchie m6 duetto-seat panel with 6 upholstery nail m6

code	finishing	q.kit	q.pack	a	b	kg.x1	vol.x1
122207-019	● faggio/plywood	x1	20	395	410	0,74	mc. 0,003

10 duetto-vite tbl combi m6x8 dentell. zincata bianca (vite per fissaggio pannello) duetto-screw tbl combi m6x12 white zinc (screw for fix panel)

code	finishing	q.kit
117711-207	○ zincata bianca/white zinc	x6

18 cpg-copertina in plastica per telaio girevole cpg-plastic cover for swivel frame

code	finishing	q.kit	q.pack	a	b	c	d	o	kg.x1	vol.x1
130903-000	● nero/black	x1	50	60	200	210	167	36	0,1	mc. 0,0015

CPG
plastic cover for swivel frame



for all colour codes, see page 171

duetto

bench



plastic colours

- blu/blue ral 5014
- nero/black
- grigio/gray ral 7003
- bianco/white 218
- rosso/red 527

19 07 08 09 10

main component sizes

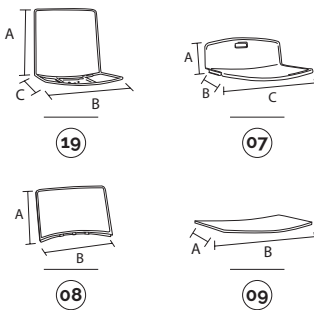

19 duetto-supporto per attacco scocca duetto su panca
duetto-bench frame for feel shell

code	finishing	q.kit	q.pack	a	b	c	kg.x1	vol.x1
110710-018	● cromato/chrome	x1	100	400	430	390	3,70	mc. 0.02

07 duetto-sedile a vista in plastica colorato + pf1 neutri
duetto-plastic seat colored + pf1 neutri

code	finishing	q.kit	q.pack	a	b	c	kg.x1	vol.x1
132203-022	● nero/black	x1	10	180	390	430	0,80	mc. 0.09

08 duetto-schienale a vista in plastica colorato
duetto-plastic back colored

code	finishing	q.kit	q.pack	a	b	kg.x1	vol.x1
132103-022	● nero/black	x1	20	280	395	0,40	mc. 0.03

09 duetto-pannello sedile multistrato con 6 borchie m6
duetto-seat panel with 6 upholstery nail m6

code	finishing	q.kit	q.pack	a	b	kg.x1	vol.x1
122207-019	● faggio/plywood	x1	20	395	410	0,74	mc. 0.003

10 duetto-vite tbl combi m6x8 dentell. zincata bianca (vite per fissaggio pannello)
duetto-screw tbl combi m6x12 white zinc (screw for fix panel)

code	finishing	q.kit
117711-207	○ zincata bianca/white zinc	x6

for the bench components, see page 249



for all colour codes, see page 171

optionals

OPTIONAL
bench
connector

E-USB **NEW**
bench plug



JIM **NEW**
bench leg

APOLL
bench arm



plastic

90GM
bench leg

90GF
bench leg

100GM
bench leg

200GM
bench leg

PIONEER
bench arm



metal

CUT
bench leg

SLIM
bench leg

CUT
bench arm

SLIM
bench arm



aluminium

duetto

optional colour codes



plastic colour codes



07 sedile in plastica
plastic seat

- 132215-022 blu/blue ral 5014
- 132203-022 nero/black
- 132204-022 grigio/gray ral 7003
- 132205-022 bianco/white 218
- 132202-022 rosso/red 527



08 schienale in plastica
plastic backrest

- 132115-022 blu/blue ral 5014
- 132103-022 nero/black
- 132104-022 grigio/gray ral 7003
- 132105-022 bianco/white 218
- 132102-022 rosso/red 527



12 braccioli in plastica
plastic armrests

- 131715-075 blu/blue ral 5014
- 131703-075 nero/black
- 131704-075 grigio/gray ral 7003
- 131705-075 bianco/white 218
- 131702-075 rosso/red 527



20 sedile in plastica per sgabello
plastic seat for stool frame

- 132215-028 blu/blue ral 5014
- 132203-028 nero/black
- 132204-028 grigio/gray ral 7003
- 132205-028 bianco/white 218
- 132202-028 rosso/red 527





BEYOND **Design**





manila



manila



slide

4 legs

swivel

bench

manila showing



tools



brochure



La monoscocca in plastica con braccioli integrati.

Una seduta ampia, confortevole e resistente, dal design sottile e distintivo, con braccioli disegnati per abbracciarla. Estremamente versatile grazie al ricco assortimento di telai, opzionabili anche in diverse finiture.

Plus:

- dimensioni generose e massimo comfort della scocca;
- design distintivo grazie ai braccioli integrati e alla scocca unica;
- 6 colori di tendenza disponibili per la scocca;
- massima versatilità;
- opzionabile il pannellino in legno da tappezzare.

Manila è nata per arredare qualsiasi **ambiente Community** e ben si adatta agli **ambienti Office**.

Plastic monocoque chair with integrated armrests.

A generous, comfortable and durable seat, featuring a subtle-yet-distinctive design, with armrests designed to embrace. Extremely versatile thanks to the rich assortment of frames. Available in a range of finishes.

Advantages:

- *generously-dimensioned seat shell providing maximum comfort;*
- *distinctive design thanks to the integrated armrests and the unique seat shell;*
- *6 trendy colours available for the seat shell;*
- *maximum versatility;*
- *optional wooden seat pad to be upholstered.*

Manila was created to furnish any **Community environment** and adapts perfectly also to **Office environments**.

manila

slide



plastic colours

- rosso/red p1797u
- grigio/grey warm grey 6c
- avorio/ivory ral1013
- marrone/brown ral69g
- giallo/yellow ral110u
- blu/blue ral5014

main component sizes

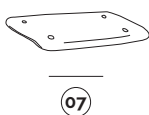
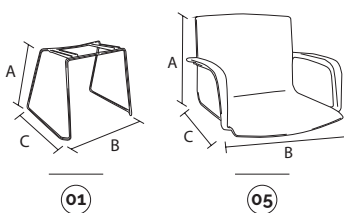

optipnats

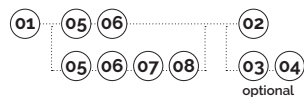
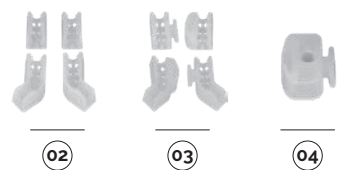

01 manila-telaio a slitta in tondino d.12 manila-slide wire framed.12

code	finishing	q.kit	q.pack	a	b	c	kg.x1	vol.x1
113403-333	● nero/black	x1	100	445	580	495	4,00	mc. 0,026
113405-333	○ avorio/ivory ral1013	x1	100	445	580	495	4,00	mc. 0,026
113410-333	● cromato/chrome	x1	100	445	580	495	4,00	mc. 0,026

02 btf-kit piedini btf-kit feet

code	finishing	q.kit	q.pack	kg.x1
134306-001	○ neutro/neutral	x1	100	0,05

03 btfa-kit piedini con ganci btfa-kit feet with hooks

code	finishing	q.kit	q.pack	kg.x1
134306-002	○ neutro/neutral	x1	100	0,06

04 pptf-tappo per fissaggio pavimento pptf-cap for fixing to the floor

code	finishing	q.kit	q.pack	kg.x1
134306-003	○ neutro/neutral	x2	100	0,03

05 manila-scocca intera con braccioli manila-plastic shell with arms

code	finishing	q.kit	q.pack	a	b	c	kg.x1	vol.x1
133904-045	● grigio/grey warm grey 6c	x1	5	390	580	480	2,60	mc. 0,05

06 manila-vite tc-combi 6x16 testa cilindrica a croce zincata (vite per fissaggio scocca) manila-screw combi 6x16 cylindrical head cross zinc (screw for fix shell)

code	finishing	q.kit
117811-181	● zincata/zinc	x4

07 manila-pannello sedile multistrato con 6 borchie m6 manila-seat panel with 6 upholstery nail m6

code	finishing	q.kit	q.pack	kg.x1	vol.x1
122207-034	● faggio/plywood	x1	20	0,78	mc. 0,003

08 manila-vite tbl combi m6x12 zincata bianca (vite per fissaggio pannello) manila-screw tbl combi m6x12 white zinc (screw for fix panel)

code	finishing	q.kit
117711-206	○ zincata bianca/white zinc	x6



for all colour codes, see page 181

manila

slide



plastic colours

- rosso/red p1797u
- grigio/grey warm grey 6c
- avorio/ivory ral1013
- marrone/brown ral699
- giallo/yellow ral110u
- blu/blue ral5014

main component sizes

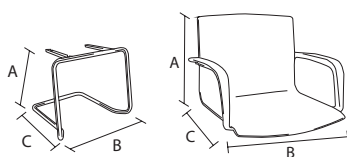

09 manila-base a slitta in tubo asform d.22 tappi esclusi
manila-slide frame asform pipe d.22 without caps

code	finishing	q.kit	q.pack	a	b	c	kg.x1	vol.x1
110503-417	● nero/black	x1	64	450	545	545	4,10	mc. 0.0313
110504-417	● grigio/grey ig2621	x1	64	450	545	545	4,10	mc. 0.0313
110505-417	○ avorio/ivory ral1013	x1	64	450	545	545	4,10	mc. 0.0313
110510-417	● cromato/chrome	x1	64	450	545	545	4,10	mc. 0.0313

10 p2p-pinza due pioli in polietilene nera
p2p-two pins pliers in black polythene

code	finishing	q.kit
134003-003	● nero/black	x6

05 manila-scocca intera con braccioli
manila-plastic shell with arms

code	finishing	q.kit	q.pack	a	b	c	kg.x1	vol.x1
133904-045	● grigio/grey warm grey 6c	x1	5	390	580	480	2,60	mc. 0.05

06 manila-vite tc•combi 6x16 testa cilindrica a croce zincata (vite per fissaggio scocca)
manila-screw combi 6x16 cylindrical head cross zinc (screw for fix shell)

code	finishing	q.kit
117811-181	● zincata/zinc	x4

07 manila-pannello sedile multistrato con 6 borchie m6
manila-seat panel with 6 upholstery nail m6

code	finishing	q.kit	q.pack	kg.x1	vol.x1
122207-034	● faggio/plywood	x1	20	0,78	mc. 0.003

08 manila-vite tbl combi m6x12 zincata bianca (vite per fissaggio pannello)
manila-screw tbl combi m6x12 white zinc (screw for fix panel)

code	finishing	q.kit
117711-206	○ zincata bianca/white zinc	x6



for all colour codes, see page 181

manila

4-legs

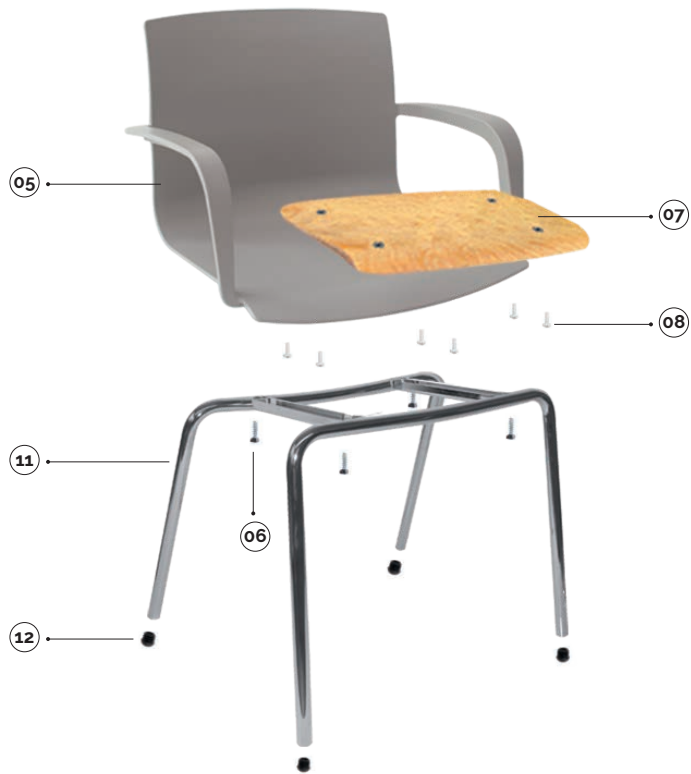

plastic colours

- rosso/red p1797u
- grigio/grey warm grey 6c
- avorio/ivory ral1013
- marrone/brown ral69g
- giallo/yellow ral110u
- blu/blue ral5014

main component sizes

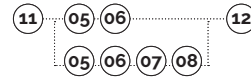
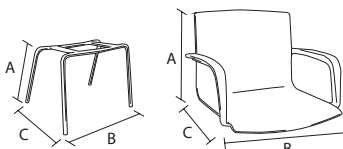

11 manila-telaio 4 gambe d.22 senza tappi
manila-4 legs frames d.22 without caps

code	finishing	q.kit	q.pack	a	b	c	kg.x1	vol.x1
110103-259	● nero/black	x1	80	440	585	490	2,70	mc. 0.035
110104-259	● grigio/grey ig2621	x1	80	440	585	490	2,70	mc. 0.035
110105-259	○ avorio/ivory ral1013	x1	80	440	585	490	2,70	mc. 0.035
110110-259	● cromato/chrome	x1	80	440	585	490	2,70	mc. 0.035

12 tappo 22 testa sferica nero
cap 22 spherical head black

code	finishing	q.kit
134203-224	● nero/black	x4

05 manila-scocca intera con braccioli
manila-plastic shell with arms

code	finishing	q.kit	q.pack	a	b	c	kg.x1	vol.x1
133904-045	● grigio/grey warm grey 6c	x1	5	390	580	480	2,60	mc. 0.05

06 manila-vite tc•combi 6x16 testa cilindrica a croce zincata (vite per fissaggio scocca)
manila-screw combi 6x16 cylindrical head cross zinc (screw for fix shell)

code	finishing	q.kit
117811-181	● zincata/zinc	x4

07 manila-pannello sedile multistrato con 6 borchie m6
manila-seat panel with 6 upholstery nail m6

code	finishing	q.kit	q.pack	kg.x1	vol.x1
122207-034	● faggio/plywood	x1	20	0,78	mc. 0.003

08 manila-vite tbi combi m6x12 zincata bianca (vite per fissaggio pannello)
manila-screw tbi combi m6x12 white zinc (screw for fix panel)

code	finishing	q.kit
117711-206	○ zincata bianca/white zinc	x6



for all colour codes, see page 181

manila

swivel



plastic colours

- rosso/red p1797u
- grigio/grey warm grey 6c
- avorio/ivory ral1013
- marrone/brown ral699
- giallo/yellow ral110u
- blu/blue ral5014

main component sizes

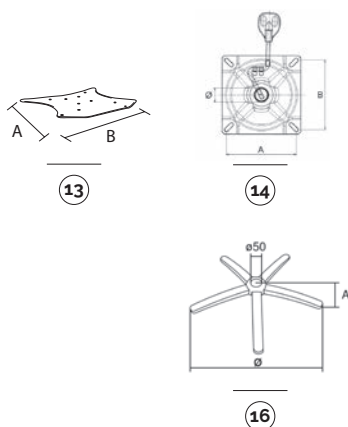

optional

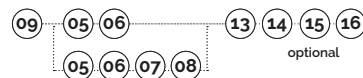
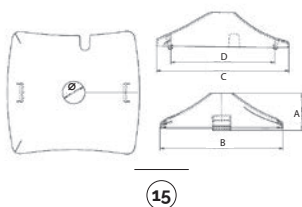

13 manila-telaio per girevole/panca manila-swivel/bench frame

code	finishing	q.kit	q.pack	a	b	kg.x1	vol.x1
110903-256	● nero/black	x1	10	265	325	2,00	mc. 0.0019
110904-256	● grigio/grey ig2621	x1	10	265	325	2,00	mc. 0.0019

14 pss28nr-piastra sgabello c/spat. c/28 3' l4 nera pss28nr- square metal plate with straight lever c/28 3' l4

code	finishing	q.kit	q.pack	a	b	ø	kg.x1	vol.x1
113003-104	● nero/black	x1	25	150	150	28	1,23	mc. 0.002

15 cpg-copertina in plastica per telaio girevole cpg-plastic cover for swivel frame

code	finishing	q.kit	q.pack	a	b	c	d	ø	kg.x1	vol.x1
130903-000	● nero/black	x1	50	60	200	210	167	36	0,1	mc. 0.0015

16 b40-base in metallo d.640 con coprisaldatura b40-metal base d.640 with cover welding

code	finishing	q.kit	q.pack	a	ø	kg.x1	vol.x1
110210-027	● cromato/chrome	x1	5	60	640	2,85	mc. 0.014

for the components below, see page 178

05 06 07 08

CPG
plastic cover for swivel frame



for all colour codes, see page 181

manila

bench



plastic colours

- rosso/red p1797u
- grigio/grey warm grey 6c
- avorio/ivory ral1013
- marrone/brown ral699
- giallo/yellow ral110u
- blu/blue ral5014

main component sizes

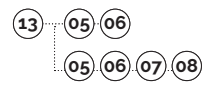
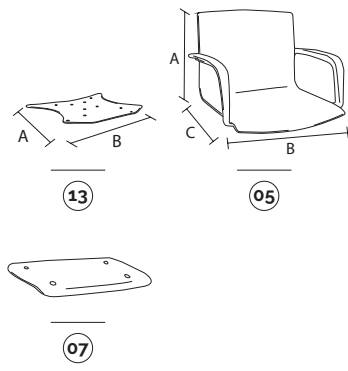

13 manila-telaio per girevole/panca
manila-swivel/bench frame

code	finishing	q.kit	q.pack	a	b	kg.x1	vol.x1
110903-256	● nero/black	x1	10	265	325	2,00	mc. 0,0019
110904-256	● grigio/grey ig2621	x1	10	265	325	2,00	mc. 0,0019

05 manila-scocca intera con braccioli
manila-plastic shell with arms

code	finishing	q.kit	q.pack	a	b	c	kg.x1	vol.x1
133904-045	● grigio/grey warm grey 6c	x1	5	390	580	480	2,60	mc. 0,05

06 manila-vite tc*combi 6x16 testa cilindrica a croce zincata (vite per fissaggio scocca)
manila-screw combi 6x16 cylindrical head cross zinc (screw for fix shell)

code	finishing	q.kit
117811-181	● zincata/zinc	x4

07 manila-pannello sedile multistrato con 6 borchie m6
manila-seat panel with 6 upholstery nail m6

code	finishing	q.kit	q.pack	kg.x1	vol.x1
122207-034	● faggio/plywood	x1	20	0,78	mc. 0,003

08 manila-vite tbi combi m6x12 zincata bianca (vite per fissaggio pannello)
manila-screw tbi combi m6x12 white zinc (screw for fix panel)

code	finishing	q.kit
117711-206	○ zincata bianca/white zinc	x6

for the bench components, see page 249

for all colour codes, see page 181

optionals

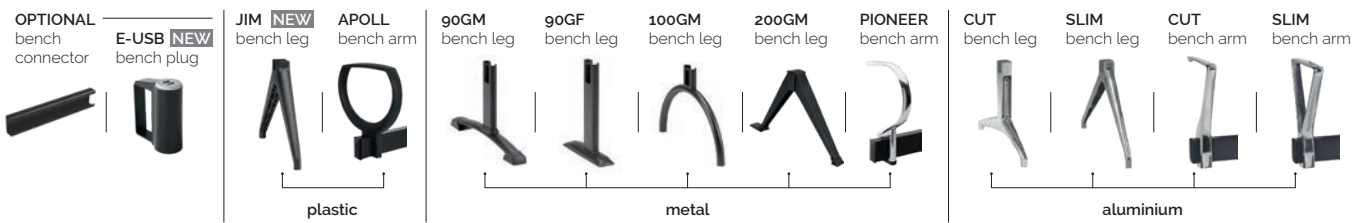

manila

optional colour codes



shell colour codes



05 scocche in plastica
plastic shells

- 133902-045 rosso/red p1797u
- 133904-045 grigio/grey warm grey 6c
- 133905-045 avorio/ivory ral1013
- 133907-045 marrone/brown ral699
- 133908-045 giallo/yellow ral110u
- 133915-045 blu/blue ral5014





BEYOND | **Solutions**





pluto



pluto



slide
slide w/armrests

4 legs
4 legs w/armrests
4 legs w/writing tablet
stool

swivel

bench

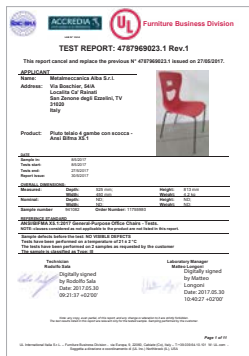

BIFMA TEST
only for 2 mm thickness
4-legs special frame



tools



certification



brochure

pluto showing

features



plastic protection



La monococca dal design moderno ed essenziale.

Estremamente versatile e funzionale vanta uno stile minimale, caratterizzato dal particolare foro centrale della monococca. Diversi i telai abbinabili; opzionabili il pannellino in plastica da tappezzare e i pratici agganci laterali.

Plus:

- design minimal in 6 diversi colori di tendenza;
- massima versatilità con la monococca abbinabile a diversi tipi di telai;
- plastiche per outdoor;
- impilabilità ed estrema facilità di pulizia.

Pluto è una buona soluzione per l'**ambiente Contract** e l'**ambiente Home**.

Monocoque chair with a modern and essential design.

Extremely versatile and functional, it boasts minimalist styling, characterized by the distinctive central hole of the monocoque. Full range of matching frames; with optional plastic seat pad to be upholstered and practical lateral hooks.

Advantages:

- minimalist design in 6 different trendy colours;
- highly versatile monocoque design that can be combined with different types of frames;
- plastics for outdoor use;
- stackable and extremely easy to clean.

Pluto is your ideal solution for **Contract environment** and the **Home environments**.

pluto

slide

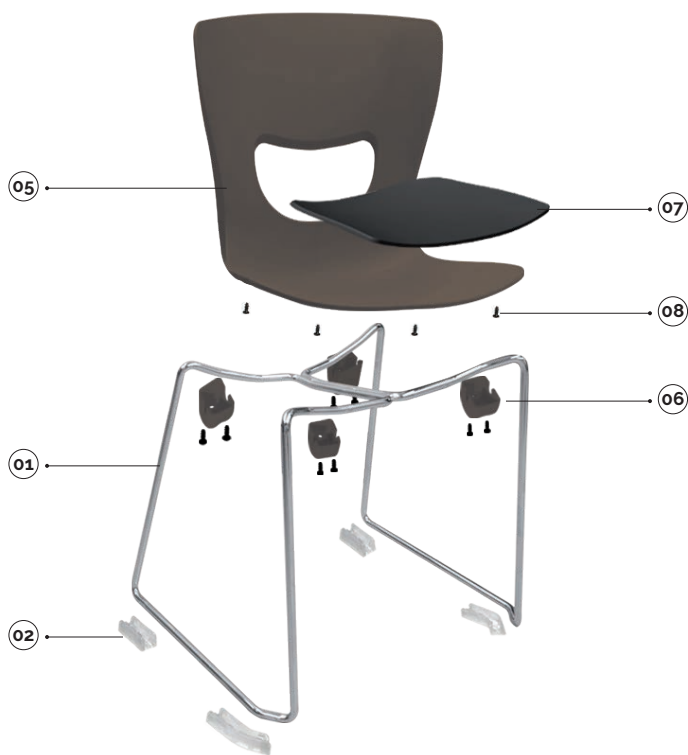

plastic colours

- rosso/red p1797u
- marrone/brown ral 8022
- grigio/grey ral7003
- avorio/ivory ral1013
- giallo/yellow ral1012
- blu/blue ral5014

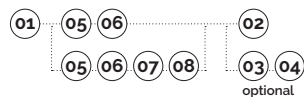

main component sizes

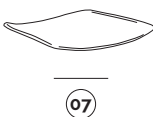
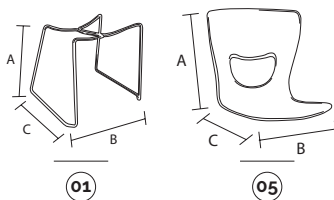

optional

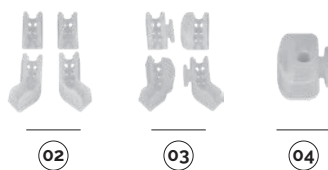

01 pluto-telaio a slitta in tondino d.12 pluto-slide wire frame d.12

code	finishing	q.kit	q.pack	a	b	c	kg.x1	vol.x1
113410-044	● cromato/chrome	x1	100	430	470	450	3,40	mc. 0.03

02 btf-kit piedini btf-kit feet

code	finishing	q.kit	q.pack	kg.x1
134306-001	○ neutro/neutral	x1	100	0,05

03 btf-kit piedini con ganci btf-kit feet with hooks

code	finishing	q.kit	q.pack	kg.x1
134306-002	○ neutro/neutral	x1	100	0,06

04 pptf-tappo per fissaggio pavimento pptf-cap for fixing to the floor

code	finishing	q.kit	q.pack	kg.x1
134306-003	○ neutro/neutral	x2	100	0,03

05 pluto-scocca intera modello pluto pluto-plastic shell model pluto

code	finishing	q.kit	q.pack	a	b	c	kg.x1	vol.x1
133907-065	● marrone/brown ral8022	x1	10	415	410	410	1,946	mc. 0.02

06 pluto-confezione accessori per scocca pluto per filo pluto-accessory pack for shell pluto for wire

code	finishing	q.kit	q.pack	kg.x1	vol.x1
137003-004	● marrone/brown ral8022	x1	10	telaio in tondino/wire frame	0,085 mc. 0.001

07 pluto-pannello sedile da tappezzare pluto-panel back for upholstery

code	finishing	q.kit	q.pack	vol.x1
132203-047	● nero/black	x1	20	mc. 0.003

08 confezione viti tbl+ fr.hilo d.5x14 zinc.black (to fix seat panel) package

code	finishing	q.kit	q.pack
117003-071	● nero/black	x4	200



for all colour codes, see page 195

pluto

slide w/armrests

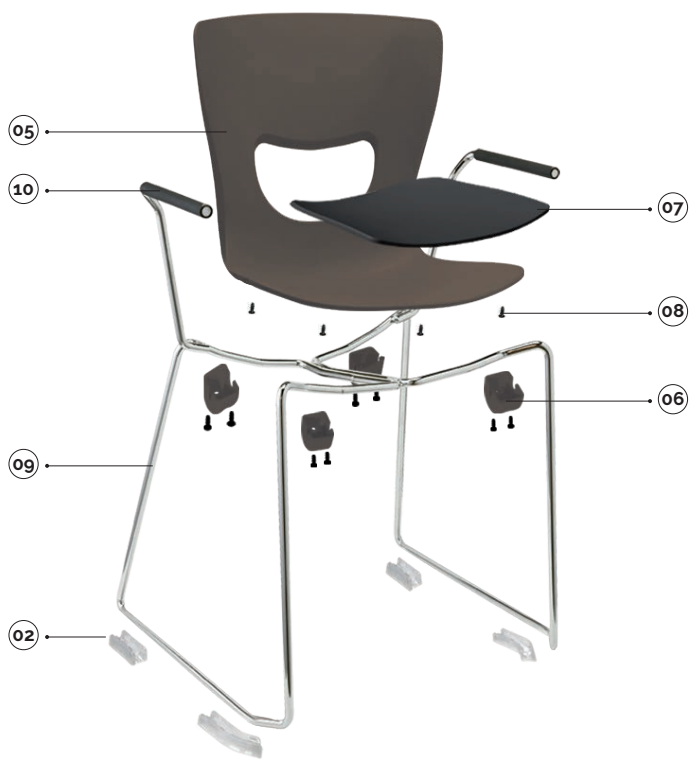

plastic colours

- rosso/red p1797u
- marrone/brown ral 8022
- grigio/grey ral7003
- avorio/ivory ral1013
- giallo/yellow ral1012
- blu/blue ral5014

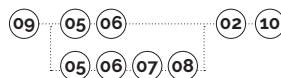

main component sizes

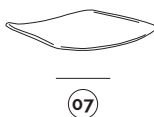
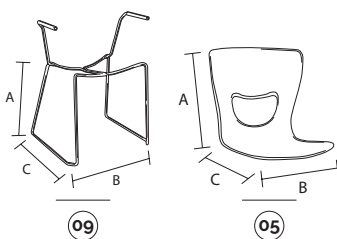

optional



09 pluto-telaio a slitta in tondino d.12 con braccioli
pluto-slide wire frame d.12 with arms

code	finishing	q.kit	q.pack	a	b	c	kg.x1	vol.x1
113410-043	● cromato/chrome	x1	60	430	470	450	4,20	mc. 0.035

10 pluto-braccioli per telaio slitta in soft grip nero
pluto-arm for wire frame in soft grip black

code	finishing	q.kit
131703-022	● nero/black	x2

02 btf-kit piedini
btf-kit feet

code	finishing	q.kit	q.pack	kg.x1
134306-001	○ neutro/neutral	x1	100	0,05

05 pluto-scocca intera modello pluto
pluto-plastic shell model pluto

code	finishing	q.kit	q.pack	a	b	c	kg.x1	vol.x1
133907-065	● marrone/brown ral8022	x1	10	415	410	410	1,946	mc. 0.02

06 pluto-confezione accessori per scocca pluto per filo
pluto-accessory pack for shell pluto for wire

code	finishing	q.kit	q.pack	kg.x1	vol.x1
137003-004	● marrone/brown ral8022	x1	10	telaio in tondino/wire frame	0,085 mc. 0.001

07 pluto-pannello sedile da tappezzare
pluto-panel back for upholstery

code	finishing	q.kit	q.pack	vol.x1
132203-047	● nero/black	x1	20	mc. 0.003

08 confezione viti tbl+fr 5x14 (per pannello da tappezzare)
screws tbl+ fr hilo d.5x14 zinc.black (to fix seat panel) package

code	finishing	q.kit	q.pack
117003-071	● nero/black	x4	200



for all colour codes, see page 195

pluto

4-legs



CERTIFIED BY
BIFMA

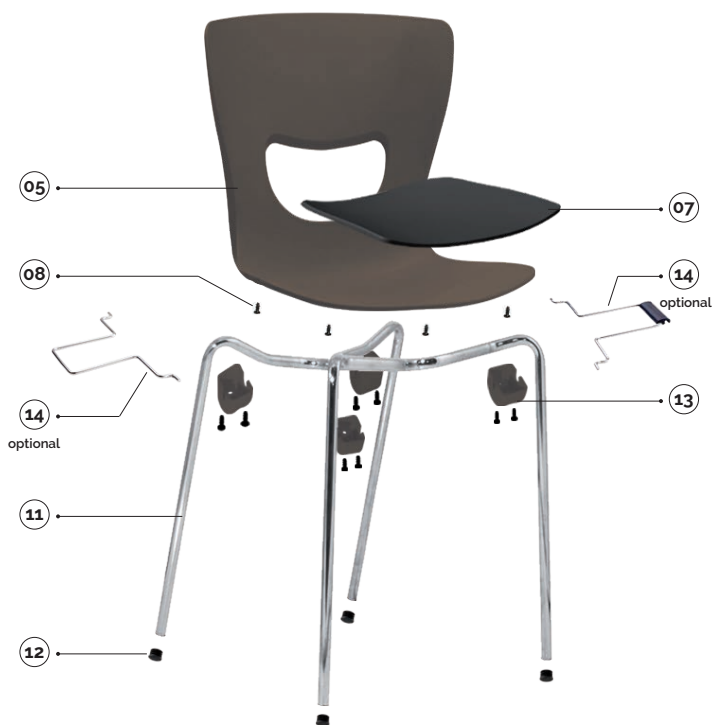

plastic colours

- rosso/red p1797u
- marrone/brown ral 8022
- grigio/grey ral7003
- avorio/ivory ral1013
- giallo/yellow ral1012
- blu/blue ral5014

main component sizes

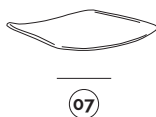
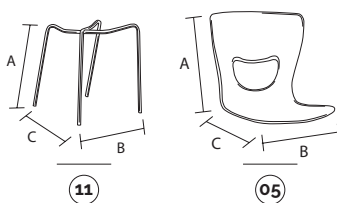

optional parts

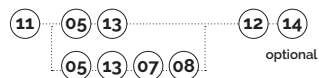
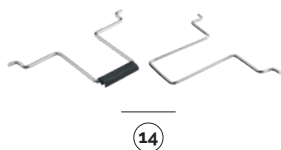

11 pluto-telaio 4 gambe in tubo d.18 senza tappi pluto-4 legs frame d.18 without caps

code	finishing	q.kit	q.pack	a	b	c	kg.x1	vol.x1
110603-022	● nero/black	x1	200	450	450	520	1,70	mc. 0,02
110604-022	● grigio/grey ig2621	x1	200	450	450	520	1,70	mc. 0,02
110605-023	○ avorio/ivory ral1013	x1	200	450	450	520	1,70	mc. 0,02
110610-135	● cromato/chrome	x1	200	450	450	520	1,70	mc. 0,02

12 confezione puntali tondi d.18 neri black inner round caps d.18 package

code	finishing	q.kit	q.pack
137003-072	● nero/black	x4	200
134205-181	○ bianco/white	x4	

05 pluto-scocca intera modello pluto pluto-plastic shell model pluto

code	finishing	q.kit	q.pack	a	b	c	kg.x1	vol.x1
133907-065	● marrone/brown ral8022	x1	10	415	410	410	1,946	mc. 0,02

13 pluto-confezione accessori per scocca pluto per tubo plutoaccessory pack for shell pluto for tube

code	finishing	q.kit	q.pack	kg.x1	vol.x1
137003-003	● marrone/brown ral8022	x1	10	telaio tubo/tube frame	0,085 mc. 0,001

07 pluto-pannello sedile da tappezzare pluto-panel back for upholstery

code	finishing	q.kit	q.pack	vol.x1
132203-047	● nero/black	x1	20	mc. 0,003

08 confezione viti tbl+ fr.hilo d.5x14 zinc.black (to fix seat panel) package

code	finishing	q.kit	q.pack
117003-071	● nero/black	x4	200

14 pluto-coppia agganci laterale in tondino + plastica pluto-pair side wire hooks + plastic

code	finishing	q.kit	q.pack
113410-004	● cromato/chrome	x1	50



for all colour codes, see page 195

pluto

4-legs w/armrests

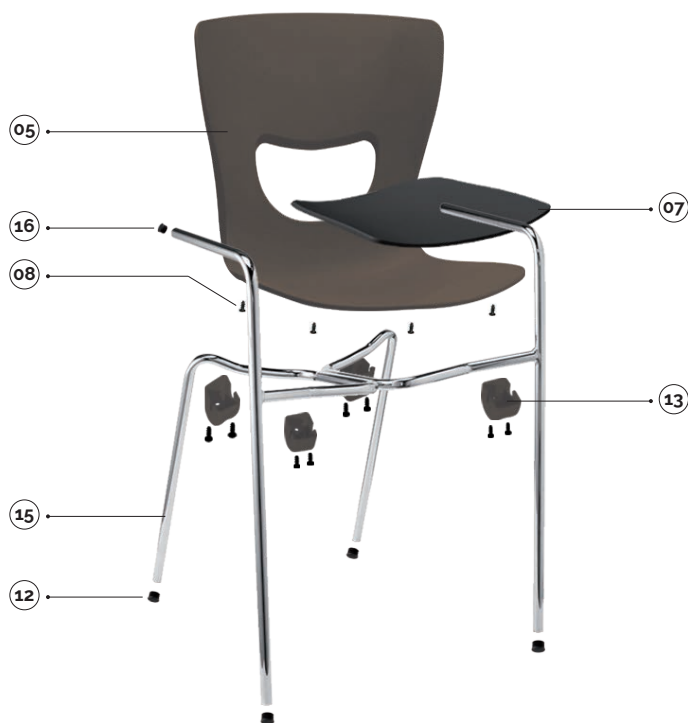

plastic colours

- rosso/red p1797u
- marrone/brown ral 8022
- grigio/grey ral7003
- avorio/ivory ral1013
- giallo/yellow ral1012
- blu/blue ral5014

main component sizes

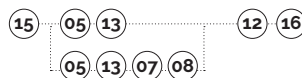
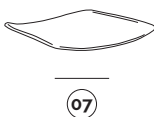
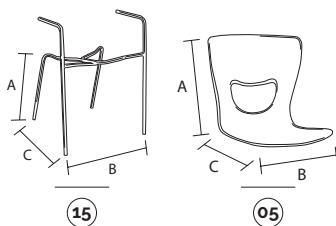

15 pluto-telaio 4 gambe con braccioli in tubo d.18 senza tappi

pluto-4 legs with armrest d.18 frame without caps

code	finishing	q.kit	q.pack	a	b	c	kg.x1	vol.x1
110603-018	● nero/black	x1	60	450	510	490	3,10	mc. 0,06
110604-018	● grigio/grey ig2621	x1	60	450	510	490	3,10	mc. 0,06
110605-018	○ avorio/ivory ral1013	x1	60	450	510	490	3,10	mc. 0,06
110610-018	● cromato/chrome	x1	60	450	510	490	3,10	mc. 0,06

12 confezione puntali tondi d.18 neri

black inner round caps d.18 package

code	finishing	q.kit	q.pack
137003-072	● nero/black	x4	200
134205-181	○ bianco/white	x4	

05 pluto-scocca intera modello pluto

pluto-plastic shell model pluto

code	finishing	q.kit	q.pack	a	b	c	kg.x1	vol.x1
133907-065	● marrone/brown ral8022	x1	10	415	410	410	1,946	mc. 0,02

13 pluto-confezione accessori per scocca pluto per tubo

plutoaccessory pack for shell pluto for tube

code	finishing	q.kit	q.pack	kg.x1	vol.x1
137003-003	● marrone/brown ral8022	x1	10	telaio tubo/tube frame	0,085 mc. 0,001

07 pluto-pannello sedile da tappezzare

pluto-panel back for upholstery

code	finishing	q.kit	q.pack	vol.x1
132203-047	● nero/black	x1	20	mc. 0,003

08 confezione viti tbl+ fr.14 d.5x14 zinc.black (per pannello da tappezzare)

screws tbl+ fr.hilo d.5x14 zinc.black (to fix seat panel) package

code	finishing	q.kit	q.pack
117003-071	● nero/black	x4	200

16 confezione tappi copritesta d.18 per braccioli

ribbed insert for arms d.18 package

code	finishing	q.kit	q.pack
137003-070	● nero/black	x2	200
134105-180	○ bianco/white	x2	



for all colour codes, see page 195

pluto

4-legs w/writing tablet



plastic colours

- rosso/red p1797u
- marrone/brown ral 8022
- grigio/grey ral7003
- avorio/ivory ral1013
- giallo/yellow ral1012
- blu/blue ral5014



main component sizes

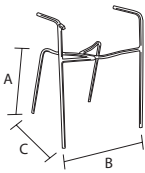

17



18

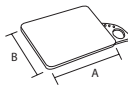

19

17 pluto-telaio 4 gambe con braccioli in tubo d.18 + aggancio portatavoletta senza tappi
pluto-4 legs with armrest d.18. tube frame without caps + hook for tablet

code	finishing	q.kit	q.pack	a	b	c	kg.x1	vol.x1
110603-069	● nero/black	x1	60	450	510	490	3,20	mc. 0,06
110604-069	● grigio/grey ig2621	x1	60	450	510	490	3,20	mc. 0,06
110605-069	○ avorio/ivory ral1013	x1	60	450	510	490	3,20	mc. 0,06
110610-069	● cromato/chrome	x1	60	450	510	490	3,20	mc. 0,06

18 pluto-spt2-snodo per tavoletta in termoplastica
pluto-spt2-thermoplastic writing tablet articulation

code	finishing	q.kit	q.pack	a	b	c	kg.x1	vol.x1
134003-039	● nero/black	x1	20	180	66	15x15	0,35	mc. 0,0006

19 pluto-tlt3-tavoletta ambidestro con portabicchiere e portapenne
pluto-tlt3-writing tablet with cup holder and pen tray

code	finishing	q.kit	q.pack	a	b	vol.x1
134003-041	● nero/black destro/right	x1	10	410	300	mc. 0,036

for the components below, see page 189



for all colour codes, see page 195

05 12 16 13 07 08



for writing tablet options, see page 242/243

pluto

stool

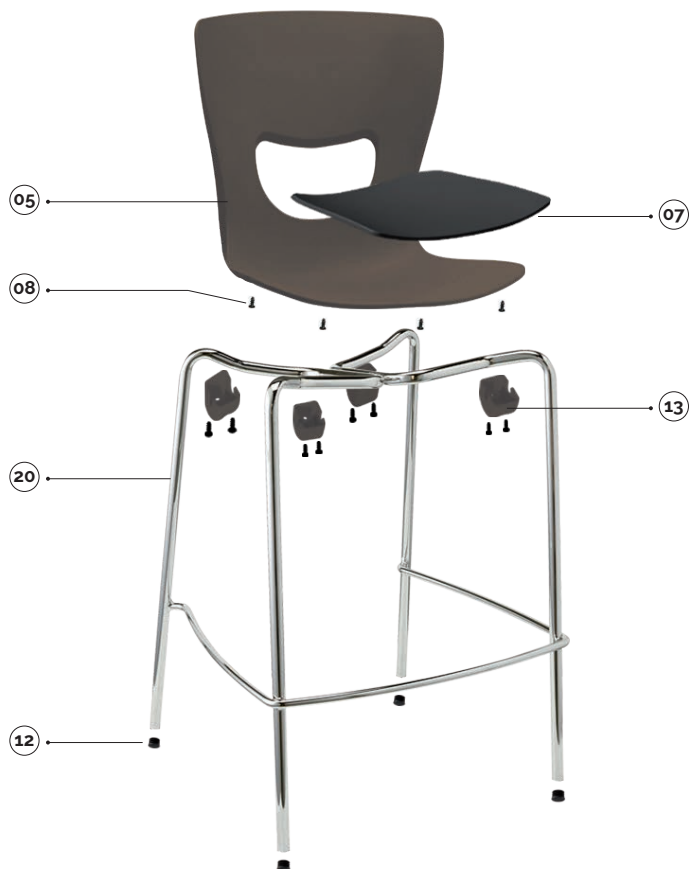

plastic colours

- rosso/red p1797u
- marrone/brown ral 8022
- grigio/grey ral7003
- avorio/ivory ral1013
- giallo/yellow ral1012
- blu/blue ral5014

main component sizes

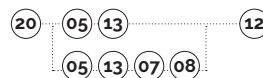
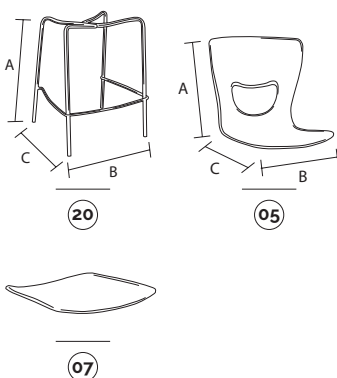

20 pluto-sgabello alto h630 in tubo per scocca senza tappi

pluto-high bar stool h630 in tube for shell pluto without caps

code	finishing	q.kit	q.pack	a	b	c	kg.x1	vol.x1
110603-039	● nero/black	x1	50	630	470	500	4,20	mc. 0,08
110604-039	● grigio/grey ig2621	x1	50	630	470	500	4,20	mc. 0,08
110605-039	○ avorio/ivory ral1013	x1	50	630	470	500	4,20	mc. 0,08
110610-039	● cromato/chrome	x1	50	630	470	500	4,20	mc. 0,08

12 confezione puntali tondi d.18 neri

black inner round caps d.18 package

code	finishing	q.kit	q.pack
137003-072	● nero/black	x4	200
134205-181	○ bianco/white	x4	

05 pluto-scocca intera modello pluto

pluto-plastic shell model pluto

code	finishing	q.kit	q.pack	a	b	c	kg.x1	vol.x1
133907-065	● marrone/brown ral8022	x1	10	415	410	410	1,946	mc. 0,02

13 pluto-confezione accessori per scocca pluto per tubo

plutoaccessory pack for shell pluto for tube

code	finishing	q.kit	q.pack	kg.x1	vol.x1
137003-003	● marrone/brown ral8022	x1	10	telaio tubo/tube frame	0,085 mc. 0,001

07 pluto-pannello sedile da tappezzare

pluto-panel back for upholstery

code	finishing	q.kit	q.pack	vol.x1
132203-047	● nero/black	x1	20	mc. 0,003

08 confezione viti tbl+ fr.hilo d.5x14 zinc.black (to fix seat panel) package

code	finishing	q.kit	q.pack
117003-071	● nero/black	x4	200



for all colour codes, see page 195

pluto

swivel



plastic colours

- rosso/red p1797u
- marrone/brown ral 8022
- grigio/grey ral7003
- avorio/ivory ral1013
- giallo/yellow ral1012
- blu/blue ral5014

main component sizes

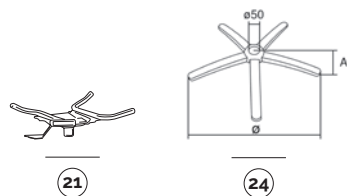
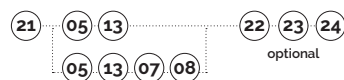

21 pluto-supporto girevole a gas per scocca pluto

pluto-swivel frame for pluto shell

code	finishing	q.kit	q.pack	kg.x1	vol.x1
110903-012	● nero/black	x1	10	1,40	mc. 0,004
110904-012	● grigio/grey ig2621	x1	10	1,40	mc. 0,004

22 confezione tappi copritesta d18 neri

black cover head caps d.18 package

code	finishing	q.kit	q.pack
137003-070	● nero/black	x1	200

23 cpg-copertina in plastica per telaio girevole

cpg-plastic cover for swivel frame

code	finishing	q.kit	q.pack	a	b	c	d	ø	kg.x1	vol.x1
130903-000	● nero/black	x1	50	60	200	210	167	36	0,1	mc. 0,0015

24 b40-base in metallo d.640 con coprisaldatura

b40-metal base d.640 with cover welding

code	finishing	q.kit	q.pack	a	ø	kg.x1	vol.x1
110210-027	● cromato/chrome	x1	5	60	640	2,85	mc. 0,014

for the components below, see page 191

05 13 07 08



for all colour codes, see page 195

optional

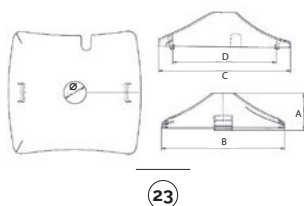

CPG
plastic cover for swivel frame



pluto

bench



plastic colours

- rosso/red p1797u
- marrone/brown ral 8022
- grigio/grey ral7003
- avorio/ivory ral1013
- giallo/yellow ral1012
- blu/blue ral5014



25 pluto-supporto per attacco scocca pluto su panca
pluto-bench frame for pluto shell

code	finishing	q.kit	q.pack	kg.x1	vol.x1
110703-188	● nero/black	x1	10	1.40	mc. 0.004

22 confezione tappi copritesta d18 neri
black cover head caps d.18 package

code	finishing	q.kit	q.pack
137003-070	● nero/black	x1	200

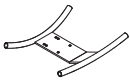

25

main component sizes

for the components below, see page 191

- 05 13 07 08



for all colour codes, see page 195

for the bench components, see page 249

optionals

OPTIONAL bench connector	E-USB NEW bench plug	JIM NEW bench leg	APOLL bench arm	90GM bench leg	90GF bench leg	100GM bench leg	200GM bench leg	PIONEER bench arm	CUT bench leg	SLIM bench leg	CUT bench arm	SLIM bench arm
		plastic		metal				aluminium				



pluto

optional colour codes



shell colour codes



05 scocche in plastica plastic shells

- 133902-065 rosso/red p1797u
- 133907-065 marrone/brown ral 8022
- 133904-065 grigio/grey ral7003
- 133905-065 avorio/ivory ral1013
- 133908-065 giallo/yellow ral1012
- 133915-065 blu/blue ral5014

accessory colour codes



06 accessori in plastica per telaio a filo plastic accessories for wire frame

- 137002-004 rosso/red p1797u
- 137003-004 marrone/brown ral 8022
- 137004-004 grigio/grey ral7003
- 137005-004 avorio/ivory ral1013
- 137008-004 giallo/yellow ral1012
- 137015-004 blu/blue ral5014



13 accessori in plastica per telaio 4-gambe/sgabello/girevole/panca plastic accessories for 4-legs/stool/swivel/bench frame

- 137002-003 rosso/red p1797u
- 137003-003 marrone/brown ral 8022
- 137004-003 grigio/grey ral7003
- 137005-003 avorio/ivory ral1013
- 137008-003 giallo/yellow ral1012
- 137015-003 blu/blue ral5014



BEYOND | **Solutions**

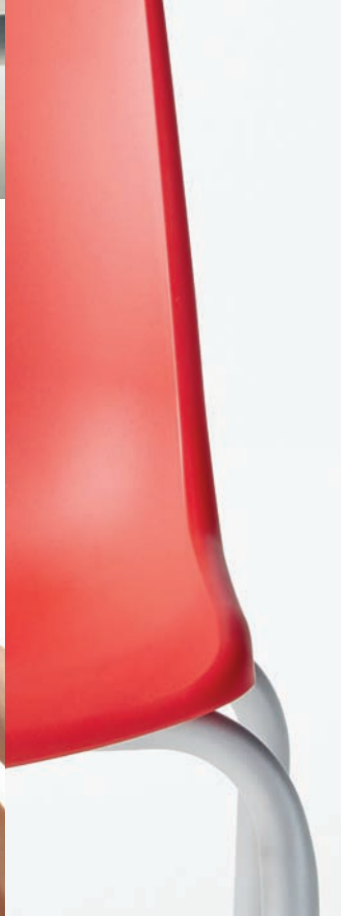



teddy



teddy



slide

4 legs

teddy showing



tools



brochure



La seduta per la scuola che rispetta la normativa.

Estremamente robusta e confortevole, **Teddy** è una soluzione pratica e versatile, perfetta per la scuola. Disponibile anche con telaio a slitta rovesciata per favorire la pulizia dell'ambiente circostante.

Plus:

- 4 dimensionalità per i telai e 2 per le scocche;
- 4 i colori disponibili della scocca, dedicati all'ambiente school;
- 3 le diverse possibili finiture dei telai;
- massima la robustezza e assoluto il confort;
- facile da sollevare grazie al foro centrale nella scocca;
- pratica da impilare.

Teddy è nata per l'ambiente scuola.

The school chair that complies with regulations.

*Extremely robust and comfortable, **Teddy** is a practical and versatile solution, perfect for schools. Also available with inverted sled frame to facilitate cleaning of the surrounding environment.*

Advantages:

- 4 sizes of frame and 2 sizes of seat shell;
- seat shell available in 4 colours, specifically selected for school environments;
- 3 different possible frame finishes;
- maximum strength and absolute comfort;
- easy to lift thanks to the central hole in the seat shell;
- practical and stackable.

Teddy was created for **school environments**.

teddy

slide

H. 460



plastic colours

- rosso/red ral3002
- giallo/yellow ral1021
- blu/blue ral517
- verde/green ral6001

01 02 03 04 05 06 07 08 09

main component sizes

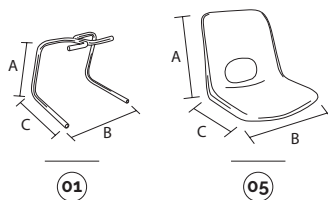

01 teddy-telaio slitta d.25 asform senza tappi 6" livello

teddy-slide frames d.25 asform without caps 6" level

code	finishing	q.kit	q.pack	a	b	c	kg.x1	vol.x1
110503-117	● nero/black	x1	64	435	455	465	4.0	mc. 0.02
110504-117	● grigio/grey ral2220	x1	64	435	455	465	4.0	mc. 0.02
110510-117	● cromato/chrome	x1	64	435	455	465	4.0	mc. 0.02

02 teddy-piedino antiribaltamento in plastica nera

teddy-black plastic anti-upsetting feet

code	finishing	q.kit
134303-016	● nero/black	x2

03 teddy-piedino posteriore in plastica nera

teddy-black plastic rear feet

code	finishing	q.kit
134303-017	● nero/black	x2

04 vite autofilettante ph tc+ 4,8x19 zincata nera

screw auto-threading ph tc+ 4,8x19 black zinc

code	finishing	q.kit
117803-165	● zincata nera/black zinc	x6

05 teddy-scocca intera modello teddy livello 5" - 6"

teddy-plastic shell model teddy level 5" - 6"

code	finishing	q.kit	q.pack	a	b	c	kg.x1	vol.x1
133915-067	● blu/blue ral517	x1	10	375	380	350	0,946	mc. 0.018

06 confezione viti hilo d.5x35 testa svasata a croce zincate

screws auto-thread 5x35 flared cross head zinc for shell fixing package

code	finishing	q.kit	q.pack
117011-070	● zincata/zinc	x4	200

07 pit-paracolpi con incavo

pit-buffer with cavity

code	finishing	q.kit
134006-103	○ neutro/neutral	x4

08 vite autoforante tc+ 4,8x16 zincata

self drilling screw +tc 4,8x16 zinc

code	finishing	q.kit
117811-152	● zincata/zinc	x4

09 tappo copritesta alettato ø25 nero

black round cover head caps d25

code	finishing	q.kit
134103-250	● nero/black	x2



for all colour codes, see page 205

teddy

4-legs

H. 350 3° LIVELLO
3° LEVEL



plastic colours

- rosso/red ral3002
- giallo/yellow ral1021
- blu/blue ral517
- verde/green ral6001

10 11 12 06

main component sizes

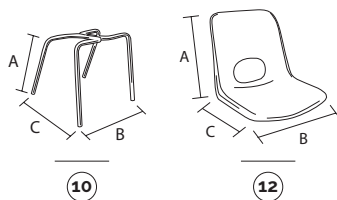

10 teddy-telaio 4 gambe d.22 senza tappi 3° livello
teddy-4 legs frames d.22 without caps 3° level

code	finishing	q.kit	q.pack	a	b	c	kg.x1	vol.x1
110103-050	● nero/black	x1	80	325	380	390	1.80	mc. 0.02
110104-050	● grigio/grey ral2220	x1	80	325	380	390	1.80	mc. 0.02
110110-050	● cromato/chrome	x1	80	325	380	390	1.80	mc. 0.02

11 tappo ø22 testa sferica
cap ø22 spherical head

code	finishing	q.kit
134203-224	● nero/black	x4

12 teddy-scocca intera modello teddy livello 3°- 4°
teddy-plastic shell model teddy level 3°- 4°

code	finishing	q.kit	q.pack	a	b	c	kg.x1	vol.x1
133916-066	● verde/green ral6001	x1	10	335	325	290	0.624	mc. 0.016

06 confezione viti hilo d.5x35 testa svasata a croce zincate
screws auto-thread 5x35 flared cross head zinc for shell fixing package

code	finishing	q.kit	q.pack
117011-070	● zincata/zinc	x4	200



for all colour codes, see page 205

teddy

4-legs

H. 380 4° LIVELLO
4° LEVEL



plastic colours

- rosso/red ral3002
- giallo/yellow ral1021
- blu/blue ral517
- verde/green ral6001

13 11 12 06

main component sizes

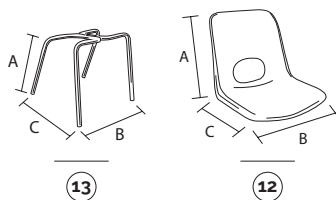

13 teddy-telaio 4 gambe d.22 senza tappi 4° livello
teddy-4 legs frames d.22 without caps 4° level

code	finishing	q.kit	q.pack	a	b	c	kg.x1	vol.x1
110103-051	● nero/black	x1	80	350	380	410	2,0	mc. 0,02
110104-051	● grigio/grey ral2220	x1	80	350	380	410	2,0	mc. 0,02
110110-051	● cromato/chrome	x1	80	350	380	410	2,0	mc. 0,02

11 tappo ø22 testa sferica
cap ø22 spherical head

code	finishing	q.kit
134203-224	● nero/black	x4

12 teddy-scocca intera modello teddy livello 3°- 4°
teddy-plastic shell model teddy level 3°- 4°

code	finishing	q.kit	q.pack	a	b	c	kg.x1	vol.x1
133902-066	● rosso/red ral3002	x1	10	335	325	290	0,624	mc. 0,016

06 confezione viti hilo d.5x35 testa svasata a croce zincate
screws auto-thread 5x35 flared cross head zinc for shell fixing package

code	finishing	q.kit	q.pack
117011-070	● zincata/zinc	x4	200



for all colour codes, see page 205

teddy

4-legs

H. 430 5° LIVELLO
5° LEVEL



plastic colours

- rosso/red ral3002
- giallo/yellow ral1021
- blu/blue ral517
- verde/green ral6001

14 11 05 06

main component sizes

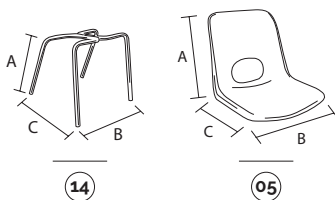

14 teddy-telaio 4 gambe d.22 senza tappi 5° livello
teddy-4 legs frames d.22 without caps 5° level

code	finishing	q.kit	q.pack	a	b	c	kg.x1	vol.x1
110103-052	● nero/black	x1	80	405	435	485	2.20	mc. 0.02
110104-052	● grigio/grey ral2220	x1	80	405	435	485	2.20	mc. 0.02
110110-052	● cromato/chrome	x1	80	405	435	485	2.20	mc. 0.02

11 tappo ø22 testa sferica
cap ø22 spherical head

code	finishing	q.kit
134203-224	● nero/black	x4

05 teddy-scocca intera modello teddy livello 5°- 6°
teddy-plastic shell model teddy level 5°- 6°

code	finishing	q.kit	q.pack	a	b	c	kg.x1	vol.x1
133908-067	● giallo/yellow ral1021	x1	10	375	380	350	0.946	mc. 0.018

06 confezione viti hilo d.5x35 testa svasata a croce zincate
screws auto-thread 5x35 flared cross head zinc for shell fixing package

code	finishing	q.kit	q.pack
117011-070	● zincata/zinc	x4	200



for all colour codes, see page 205

teddy

4-legs

H. 460
6° LIVELLO
6° LEVEL



plastic colours

- rosso/red ral3002
- giallo/yellow ral1021
- blu/blue ral517
- verde/green ral6001

15 11 05 06

main component sizes

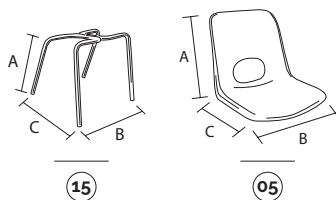

15 teddy-telaio 4 gambe d.22 senza tappi 6° livello

teddy-4 legs frames d.22 without caps 6°level

code	finishing	q.kit	q.pack	a	b	c	kg.x1	vol.x1
110103-053	● nero/black	x1	80	430	435	505	2.40	mc. 0.02
110104-053	● grigio/grey ral2220	x1	80	430	435	505	2.40	mc. 0.02
110110-053	● cromato/chrome	x1	80	430	435	505	2.40	mc. 0.02

11 tappo ø22 testa sferica

cap ø22 spherical head

code	finishing	q.kit
134203-224	● nero/black	x4

05 teddy-scocca intera modello teddy livello 5° - 6°

teddy-plastic shell model teddy level 5° - 6°

code	finishing	q.kit	q.pack	a	b	c	kg.x1	vol.x1
133915-067	● blu/blue ral517	x1	10	375	380	350	0.946	mc. 0.018

06 confezione viti hilo d.5x35 testa svasata a croce zincate

screws auto-thread 5x35 flared cross head zinc for shell fixing package

code	finishing	q.kit	q.pack
117011-070	● zincata/zinc	x4	200



for all colour codes, see page 205

teddy

optional colour codes



shell colour codes



12 scocche in plastica
plastic shells



- 133902-066 rosso/red ral3002
- 133908-066 giallo/yellow ral1021
- 133915-066 blu/blue ral517
- 133916-066 verde/green ral6001



05 scocche in plastica
plastic shells



- 133902-067 rosso/red ral3002
- 133908-067 giallo/yellow ral1021
- 133915-067 blu/blue ral517
- 133916-067 verde/green ral6001





BEYOND **Design**



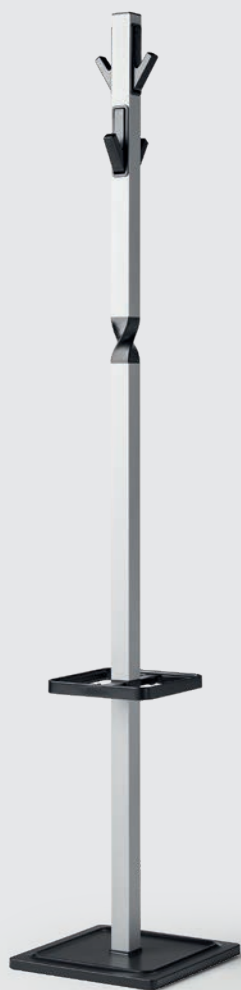

coat hangers



coat hangers



components

coat hangers showing



L'estrema funzionalità unita a un **design sempre distintivo** consentono di rendere ogni proposta di **appendiabiti AlbaComponents** degna di nota.

L'**elevata qualità** dei materiali utilizzati e la ricerca attenta delle più idonee finiture e dei colori delle plastiche, abbinate al metallo, consentono di offrire non semplici complementi ma vere e proprie soluzioni d'arredo per i diversi ambienti.

Sovente arricchiti con accessori come il **porta ombrelli** e/o il **vassoio porta oggetti**, garantiscono **massima funzionalità e praticità di utilizzo**.

*Unrivalled functionality and **distinctive designs** make every **AlbaComponents coat stand** exceptional.*

*The **superior-quality** materials used and **extensive research** into the most suitable finishes and colours of the plastics, combined with perfectly matched metals, enable us to offer not just complements but genuine furnishing solutions for different environments.*

*Often enhanced with accessories such as the **umbrella holder** and/or **objects tray**, they guarantee **maximum functionality and ease of use**.*

space

components

space showing



tools



brochure



video

features



designed by:
stefano bettio



Stile e funzionalità.

Space è il complemento d'arredo dal **design minimal e ricercato**. I suoi **agganci a scomparsa** abbinati alle possibili finiture della colonna in metallo a **sezione quadrata**, saranno la tendenza del futuro.

La sua **perfetta stabilità**, grazie alla base in metallo, e la **comodità di utilizzo** lo rendono un elemento d'arredo assolutamente indispensabile.

Plus:

- agganci a scomparsa e design a sezione quadrata della colonna;
- pratico portabombrelli;
- 3 colori disponibili;
- dimensioni di imballo molto compatte.

Space è ideale per gli ambienti **Office, Contract e Home**.

Style and functionality.

Space is the furnishing accessory with a **minimalist, highly refined design**. Its **foldaway hooks**, teamed with the possible finishes for the **square-section metal column**, are sure to become the trend for the future. **Perfect stability** is assured thanks to the metal base, and its **ease of use** makes it an absolutely indispensable furnishing element.

Advantages:

- *foldaway hooks and square-section design of the column;*
- *practical umbrella holder;*
- *available in 3 colours;*
- *very compact packaging size.*

Space is ideal for **Office, Contract and Home** environments.

space

components

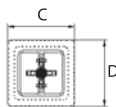
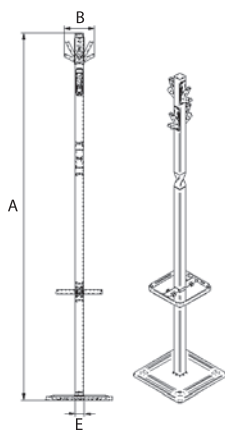
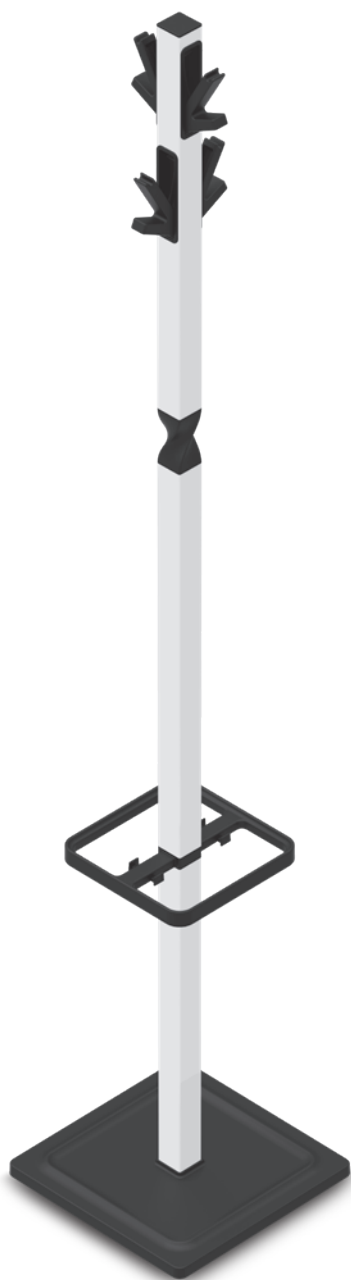

01

main component sizes

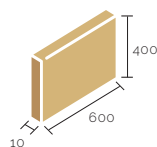

01 space-appendiabito a colonna in tubo quadro con portaombrelli componenti in plastica
space-coat hanger in square tube with umbrella stand and plastic components

code	finishing	plastic	q.kit	q.pack	a	b	c	d	e	kg.x1	vol.x1
110403-170	● nero/black	● nero/black	x1	60	1750	145	320	320	40x40	7,60	mc. 0.032
110404-170	● grigio/grey	● nero/black	x1	60	1750	145	320	320	40x40	7,60	mc. 0.032
110405-170	○ bianco/white	● nero/black	x1	60	1750	145	320	320	40x40	7,60	mc. 0.032

coat hangers

components



designed by:
stefano bettio

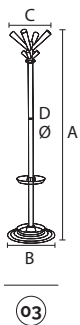
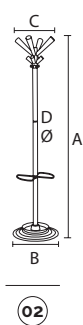
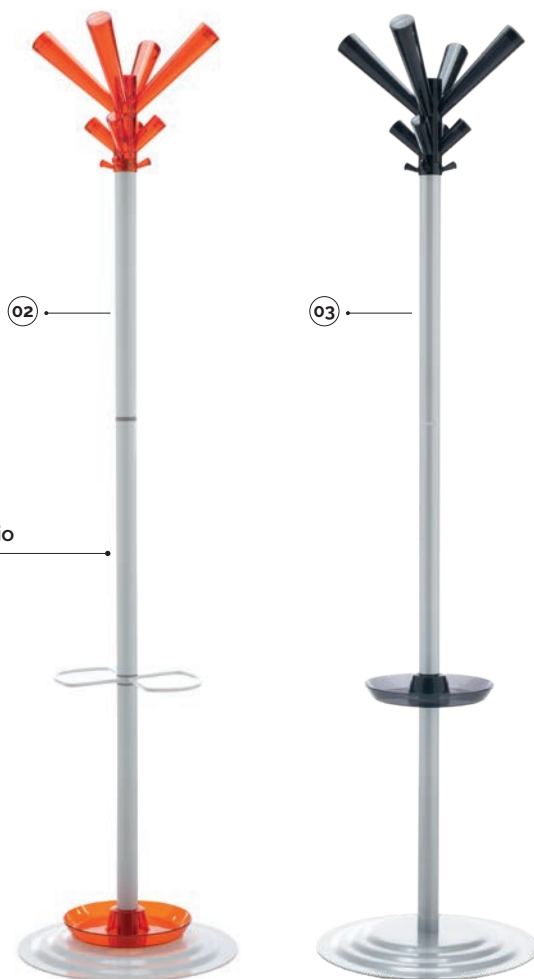

main component sizes

02 joy-appendiabito a colonna con portaombrelli componenti in plastica
joy-coat hanger with umbrella stand plastic components

code	finishing	plastic	q.kit	q.pack	a	b	c	d	kg.x1	vol.x1
110404-100	● grigio/grey	○ transparent	x1	50	1750	415	380	40	8,65	mc. 0.039
110404-101	● grigio/grey	● orange transparent	x1	50	1750	415	380	40	8,65	mc. 0.039
110404-102	● grigio/grey	● fumé transparent	x1	50	1750	415	380	40	8,65	mc. 0.039
110405-100	○ bianco/white	○ transparent	x1	50	1750	415	380	40	8,65	mc. 0.039
110405-101	○ bianco/white	● orange transparent	x1	50	1750	415	380	40	8,65	mc. 0.039
110405-102	○ bianco/white	● fumé transparent	x1	50	1750	415	380	40	8,65	mc. 0.039

03 easy-appendiabito a colonna con vassoio portaoggetti componenti in plastica
easy-coat hanger with multipurpose tray plastic components

code	finishing	plastic	q.kit	q.pack	a	b	c	d	kg.x1	vol.x1
110404-106	● grigio/grey	○ transparent	x1	50	1750	415	380	40	8,20	mc. 0.039
110404-107	● grigio/grey	● orange transparent	x1	50	1750	415	380	40	8,20	mc. 0.039
110404-108	● grigio/grey	● fumé transparent	x1	50	1750	415	380	40	8,20	mc. 0.039
110405-106	○ bianco/white	○ transparent	x1	50	1750	415	380	40	8,20	mc. 0.039
110405-107	○ bianco/white	● orange transparent	x1	50	1750	415	380	40	8,20	mc. 0.039
110405-108	○ bianco/white	● fumé transparent	x1	50	1750	415	380	40	8,20	mc. 0.039

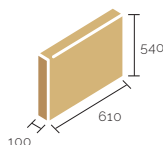
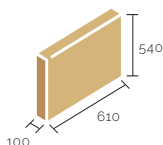

coat hangers

components



04

05

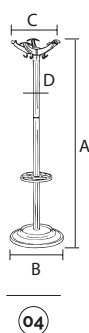

04

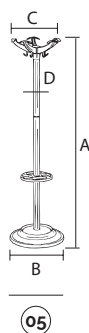

05

04 elix-appendiabito a colonna con portaombrelli, componenti in plastica neri
elix-coat hanger with umbrella stand, black plastic components

code	finishing	plastic	q.kit	q.pack	a	b	c	d	kg.x1	vol.x1
110403-040	● nero/black	● nero/black	x1	60	1730	450	400	50	5,00	mc. 0.045
110404-006	● grigio/grey	● nero/black	x1	60	1730	450	400	50	5,00	mc. 0.045
110405-015	○ bianco/white	● nero/black	x1	60	1730	450	400	50	5,00	mc. 0.045
110410-040	● cromato/chrome	● nero/black	x1	60	1730	450	400	50	5,00	mc. 0.045

05 elix-g-appendiabito a colonna con portaombrelli, componenti in plastica grigi
elix-g-coat hanger with umbrella stand, grey plastic components

code	finishing	plastic	q.kit	q.pack	a	b	c	d	kg.x1	vol.x1
110404-005	● grigio/grey	● grigio/grey	x1	60	1730	450	400	50	5,00	mc. 0.045
110410-039	● cromato/chrome	● grigio/grey	x1	60	1730	450	400	50	5,00	mc. 0.045

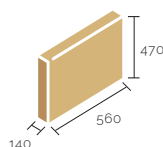
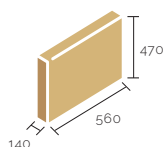

main component sizes

coat hangers

components

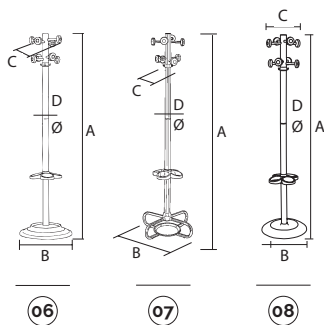

main component sizes

06 sky-appendiabito a colonna con portaombrelli, componenti in plastica colorati
sky-coat hanger with umbrella stand, plastic components coloured

code	finishing	plastic	q.kit	q.pack	a	b	c	d	kg.x1	vol.x1
110404-070	● grigio/grey	● verde/green	x1	60	1730	450	330	50	5,30	mc. 0,045
110404-075	● grigio/grey	● blu/blue	x1	60	1730	450	330	50	5,30	mc. 0,045
110404-080	● grigio/grey	● arancione/orange	x1	60	1730	450	330	50	5,30	mc. 0,045

07 bravo-appendiabito a colonna con portaombrelli, componenti in plastica neri
bravo-coat hanger with umbrella stand, plastic components black

code	finishing	plastic	q.kit	q.pack	a	b	c	d	kg.x1	vol.x1
110403-009	● nero/black	● nero/black	x1	72	1750	415	380	50	8,20	mc. 0,039
110404-029	● grigio/grey	● nero/black	x1	72	1750	415	380	50	8,20	mc. 0,039
110410-029	● cromato/chrome	● nero/black	x1	72	1750	415	380	50	8,20	mc. 0,039

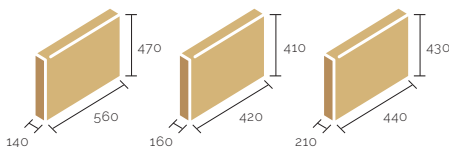

08 eco-appendiabito a colonna con portaombrelli componenti in plastica neri
eco-coat hanger with umbrella stand, plastic components black

code	finishing	plastic	q.kit	q.pack	a	b	c	d	kg.x1	vol.x1
110403-025	● nero/black	● nero/black	x1	60	1700	400	330	50	5,00	mc. 0,045
110404-120	● grigio/grey	● nero/black	x1	60	1700	400	330	50	5,00	mc. 0,045
110410-120	● cromato/chrome	● nero/black	x1	60	1700	400	330	50	5,00	mc. 0,045

coat hangers

components

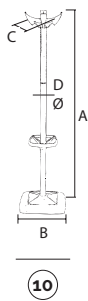
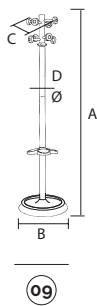

09 good-appendiabito a colonna con portaombrelli, componenti in plastica neri
good-coat hanger with umbrella stand, plastic components black

code	finishing	plastic	q.kit	q.pack	a	b	c	d	kg.x1	vol.x1
110403-050	● nero/black	● nero/black	x1	60	1720	430	330	50	5,00	mc. 0.045
110404-020	● grigio/grey	● nero/black	x1	60	1720	430	330	50	5,00	mc. 0.045
110410-030	● cromato/chrome	● nero/black	x1	60	1720	430	330	50	5,00	mc. 0.045

10 tree-appendiabito a colonna con portaombrelli, componenti in plastica neri
tree-coat hanger with umbrella stand, plastic components black

code	finishing	plastic	q.kit	q.pack	a	b	c	d	kg.x1	vol.x1
110403-065	● nero/black	● nero/black	x1	50	1730	450	300	50	4,00	mc. 0.05
110404-090	● grigio/grey	● nero/black	x1	50	1730	450	300	50	4,00	mc. 0.05
110410-070	● cromato/chrome	● nero/black	x1	50	1730	450	300	50	4,00	mc. 0.05

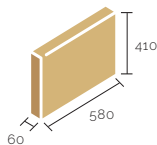
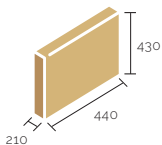

main component sizes



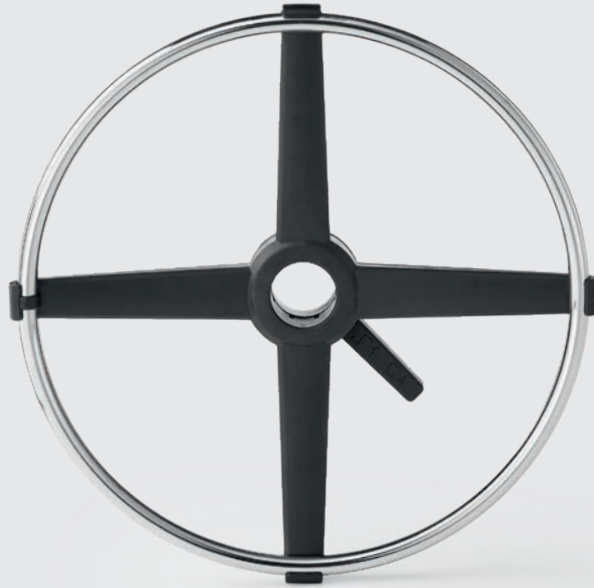

foot rings & columns



foot rings & columns



components



EN 1728

ANSI/BIFMA X5.1



tools

certification / mod. Round



certification / mod. Gravity

foot rings & columns showing



La grande **varietà di materiali** e la **qualità certificata CATAS e BIFMA**, consentono di offrire una gamma di **poggiatesti** ampia e distintiva.

La linea prevede inoltre **soluzioni tecnologicamente innovative** come **Gravity**, il nuovo sistema di chiusura dell'anello poggiatesti che ha ottenuto il **brevetto CATAS**. Disegnato da uno studio di design prestigioso prevede infatti l'innovativa chiusura con leva che garantisce un **migliore e più pratico fissaggio del poggiatesti**.

*The extensive **range of materials** combined with **CATAS and BIFMA quality certifications** enable us to offer an extensive and distinctive range of **footrests**.*

*The line also includes **technologically innovative solutions** such as **Gravity**, the new footrest ring locking system that has obtained a **CATAS patent**. Designed by a prestigious design studio the innovative lever-operated locking system assures **better and more practical locking of the footrest**.*

foot rings

components

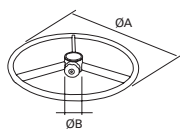

sg50t-anello poggiapiedi telescopico cromato completo di volantino
sg50t-telescopic foot ring chrome with little wheel

code	finishing	q.kit	q.pack	øa	øb	kg.x1	vol.x1
110210-008	● cromato/chrome	x1	10	450	50	1.60	mc. 0.008

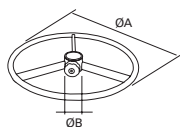

sg51t-anello poggiapiedi telescopico cromato completo di volantino
sg51t-telescopic foot ring chrome with little wheel

code	finishing	q.kit	q.pack	øa	øb	kg.x1	vol.x1
110210-081	● cromato/chrome	x1	10	500	50	1.90	mc. 0.008

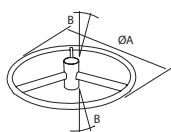

sg50f-anello poggiapiedi cromato
sg50f-fixed foot ring chrome

code	finishing	q.kit	q.pack	øa	øb	kg.x1	vol.x1
110210-005	● cromato/chrome	x1	10	450	1' 26' 16"	1.60	mc. 0.0125



patent



certification

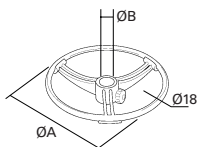

round-anello poggiapiedi telescopico con volantino
round-telescopic foot ring with little wheel

code	finishing	q.kit	q.pack	øa	øb	kg.x1	vol.x1
110210-009	● cromato/chrome	x1	10	450	50	1.40	mc. 0.0125



patent



certification



designed by:
esedra

gravity-anello poggiapiedi telescopico cromato completo di leva
gravity-telescopic foot ring chrome with little lever

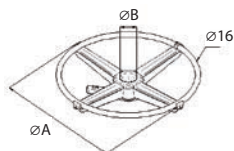

code	finishing	q.kit	q.pack	øa	øb	kg.x1	vol.x1
110210-006	● cromato/chrome	x1	10	450	50	1.10	mc. 0.0125

columns

components

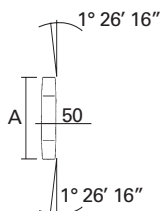

prolunga per anello poggiatesta fisso sg5f
pipe extension for foot ring sg50f

code	finishing	q.kit	q.pack	a	øb	kg.x1	vol.x1
112303-002	● cromato/chrome	x1	50	130	50	0,24	mc. 0,0031
112310-031	● nero/black	x1	50	130	50	0,24	mc. 0,0031
112303-004	● cromato/chrome	x1	50	260	50	0,48	mc. 0,0062
112310-030	● nero/black	x1	50	260	50	0,48	mc. 0,0062

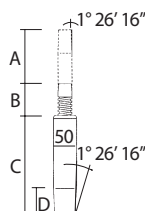

colonna alzata vite ø50, h 240
column screw ø50, h 240

code	finishing	q.kit	q.pack	a	b	c	d	kg.x1	vol.x1
112303-053	● nero/black	x1	30	130	80	240	50	0,81	mc. 0,0190
112310-002	● cromato/chrome	x1	30	130	80	240	50	0,81	mc. 0,0190

— altezza a richiesta
height on request

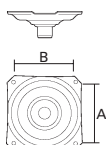
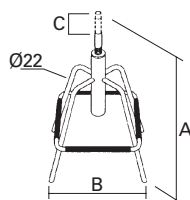
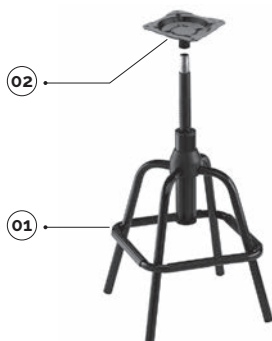

sg22-sgabelli con vitone, tappi e accessori assemblati cono ø21 imballo singolo
sg22-stool with screw, caps and accessories assembled cono ø21 single packing

code	finishing	q.kit	q.pack	a	b	c	kg.x1	vol.x1
110603-035	● nero/black	x1	1	700	330	130	3,00	mc. 0,053
110610-075	● cromato/chrome	x1	1	700	330	130	3,00	mc. 0,053
110605-002	○ bianco/white	x1	1	700	330	130	3,00	mc. 0,053

piastra sgabello cono ø21
plate for stool cono ø21

code	finishing	q.kit	q.pack	a	b	kg.x1	vol.x1
113003-100	● nero/black	x1	20	140	140	0,85	mc. 0,001



BEYOND **Solutions**





slide bases



slide bases



components



EN1728

slide bases showing



tools



certification / mod. SL40



L'ideale fondamento per ogni vostro progetto.

L'assortimento di basi **AlbaComponents** offre un **grande numero di soluzioni** in grado di rispondere alle più varie esigenze in termini di design, e di garantire i più elevati standard qualitativi.

The ideal foundation for all your projects.

The AlbaComponents range of bases offers a large selection of solutions capable of meeting the most varied needs in terms of design, and ensuring you the highest quality standards.

slide bases

components

main component sizes

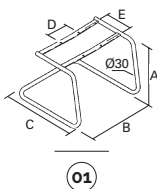

01 sl43-base a slitta in tubo ø30 tappi esclusi
sl43-slide frame pipe ø30 without caps

code	finishing	q.kit	q.pack	a	b	c	d	e	kg.x1	vol.x1
110503-003	● nero/black	x1	64	400	530	530	155	200	4,70	mc. 0.0313
110504-001	● grigio/grey	x1	64	400	530	530	155	200	4,70	mc. 0.0313
110510-020	● cromato/chrome	x1	64	400	530	530	155	200	4,70	mc. 0.0313

02 confezione tappi copritesta ø30 nero + pinze a due pioli p2p
black round cover head caps ø30 + two pins pliers in black polythene package

code	finishing	q.kit	q.pack
137003-077	● nero/black	tc30 (x2) - p2p (x6)	tc30 (130 pcs) - p2p (390 pcs)

main component sizes

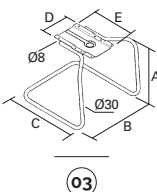

03 sl40-base a slitta in tubo ø25 tappi esclusi
sl40-slide frame pipe ø25 without caps

code	finishing	q.kit	q.pack	a	b	c	d	e	kg.x1	vol.x1
110503-021	● nero/black	x1	96	430	480	520	170	200	4,10	mc. 0.0313
110504-010	● grigio/grey	x1	96	430	480	520	170	200	4,10	mc. 0.0313
110510-002	● cromato/chrome	x1	96	430	480	520	170	200	4,10	mc. 0.0313

04 confezione tappi copritesta alettati ø25 neri + pinze a due pioli p2p
black round cover head caps d25 + two pins pliers in black polythene package

code	finishing	q.kit	q.pack
137003-076	● nero/black	tc25 (x2) - p2p (x6)	tc25 (195 pcs) - p2p (580 pcs)

05 piedino antiribaltamento in plastica nero + 2 viti
plastic black feet anti-upsetting + 2 screws

code	finishing	q.kit
134303-006	● nero/black	x2

main component sizes

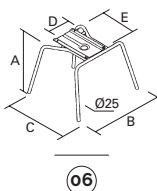

06 rg31-telaio fisso in tubo ø25 tappi esclusi
rg31-fixed frame pipe ø25 without caps

code	finishing	q.kit	q.pack	a	b	c	d	e	kg.x1	vol.x1
110603-012	● nero/black	x1	150	430	470	550	170	200	3,70	mc. 0.028
110604-041	● grigio/grey	x1	150	430	470	550	170	200	3,70	mc. 0.028
110610-017	● cromato/chrome	x1	150	430	470	550	170	200	3,70	mc. 0.028

07 puntale alettato tondo ø25 nero
ribbed round insert cap ø25 black

code	finishing	q.kit
134203-253	● nero/black	x4

slide bases

components

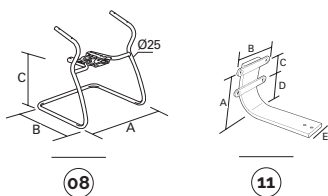
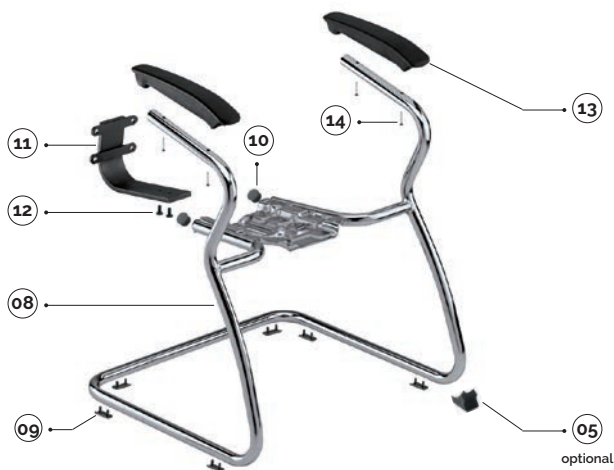

main component sizes

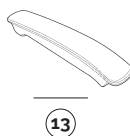

for the component below, see page 226

05

08 sl45-base a slitta in tubo ø25 con braccioli, tappi esclusi
sl45-slide frame pipe ø25 with arms without caps

code	finishing	q.kit	q.pack	a	b	c	kg.x1	vol.x1
110503-005	● nero/black	x1	50	590	560	400	5,50	mc. 0.055
110504-015	● grigio/grey	x1	50	590	560	400	5,50	mc. 0.055
110510-045	● cromato/chrome	x1	50	590	560	400	5,50	mc. 0.055

09 pinza due pioli in polietilene nera
two pins pliers in black polythene

code	finishing	q.kit
134003-003	● nero/black	x6

10 tappo copritesta alettato ø25 nero
ribbed insert ø25 black

code	finishing	q.kit
134103-250	● nero/black	x2

11 schienale fisso per base sl45/sl46
fixed back for base sl45 / sl46

code	finishing	q.kit	q.pack	a	b	c	d	e	kg.x1	vol.x1
112103-220	● nero/black	x1	10	130	100	60	70	60	1,70	mc. 0.0015

12 vite m8x25 testa cilindrica esagono incassato brunita (per fissaggio lama/piastra)
screw m8x25 cylindrical head exagon heat burnishing (for blade/plate)

code	finishing	q.kit
117703-240	● nero/black	x2

13 copribracciolo in poliuretano per base sl45 tubo ø25
cover arm in polyurethane for base sl45 tube ø25

code	finishing	q.kit	q.pack	kg.x1	vol.x1
131703-045	● nero/black	x2	25	0,24	mc. 0.001

14 vite autoflettante 5,5x38 testa svasata a croce zincata (per fissaggio copribracciolo)
screw auto-thread 5,5x38 flared cross head zinc (for fix cover arm)

code	finishing	q.kit
117811-165	● zincata/zinc	x4

slide bases

components



15 sl46-base a slitta in tubo 25 tappi esclusi
sl46-slide frame pipe ø25 without caps

code	finishing	q.kit	q.pack	a	b	c	kg.x1	vol.x1
110503-007	● nero/black	x1	64	590	560	400	4,50	mc. 0.032
110504-020	● grigio/grey	x1	64	590	560	400	4,50	mc. 0.032
110510-047	● cromato/chrome	x1	64	590	560	400	4,50	mc. 0.032

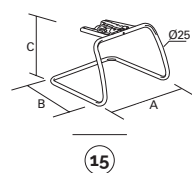

main component sizes



16 piastra adattatore per lama schienale
adapter plate for blade back

code	finishing	q.kit	q.pack	kg.x1	vol.x1
113003-150	● nero/black	x1	30	0,45	mc. 0.001

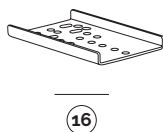

main component sizes

slide bases

components



main component sizes

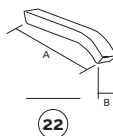
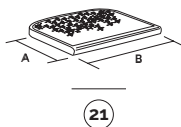
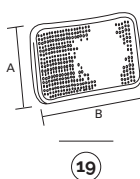
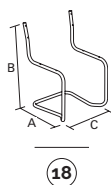
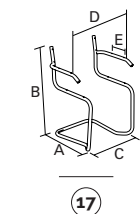

- 17** sl54-base a slitta in tubo $\varnothing 25 \times 2$ con braccioli + tappi assemblati
sl54-slide frame pipe $\varnothing 25 \times 2$ with arms + caps assembled

code	finishing	q.kit	q.pack	a	b	c	d	e	kg.x1	vol.x1
110503-037	● nero/black	x1	80	450	770	450	500	140	4,90	mc. 0,04
110504-027	● grigio/grey	x1	80	450	770	450	500	140	4,90	mc. 0,04
110510-082	● cromato/chrome	x1	80	450	770	450	500	140	4,90	mc. 0,04

- 18** sl53-base a slitta in tubo $\varnothing 25 \times 2$ con tappi assemblati
sl53-slide frame pipe $\varnothing 25 \times 2$ caps assembled

code	finishing	q.kit	q.pack	a	b	c	kg.x1	vol.x1
110503-035	● nero/black	x1	120	450	770	450	4,10	mc. 0,04
110504-025	● grigio/grey	x1	120	450	770	450	4,10	mc. 0,04
110510-080	● cromato/chrome	x1	120	450	770	450	4,10	mc. 0,04

- 19** 53sh-schienale in faggio verniciato in canna
53sh-beech back cane painted

code	finishing	q.kit	q.pack	a	b	kg.x1	vol.x1
122103-005	● nero/black	x1	10	270	460	0,73	mc. 0,005
122107-005	● naturale/natural	x1	10	270	460	0,73	mc. 0,005

- 20** vite truciolare testa svasata bombata a croce $\varnothing 4,2 \times 38$
shaving screw flared rounded cross $\varnothing 4,2 \times 38$

code	finishing	q.kit
117803-126	● nero/black	x8
117811-127	● zincata/zinc	x8

- 21** 53sd-sedile in faggio verniciato in canna
53sd-beech seat cane painted

code	finishing	q.kit	q.pack	a	b	kg.x1	vol.x1
122203-010	● nero/black	x1	10	415	465	1,37	mc. 0,008
122207-010	● naturale/natural	x1	10	415	465	1,37	mc. 0,008

- 22** 53b-coppia braccioli in faggio verniciato
53b-pair of beech arms painted

code	finishing	q.kit	q.pack	a	b	kg.x1	vol.x1
121703-005	● nero/black	x1	35	310	40	0,42	mc. 0,002
121707-005	● naturale/natural	x1	35	310	40	0,42	mc. 0,002

- 14** vite autofilettante $5,5 \times 38$ testa svasata a croce zincata (per fissaggio bracciolo)
screw auto-thread $5,5 \times 38$ flared cross head zinc (for fix arm)

code	finishing	q.kit
117811-165	● zincata/zinc	x4



BEYOND | **Solutions**





bases



bases

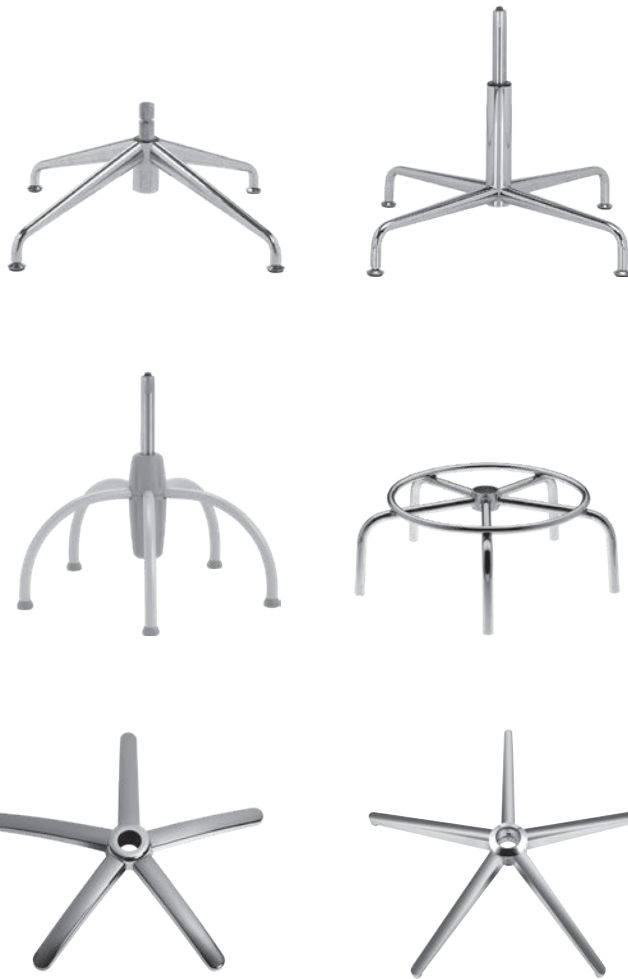

components

CATAS Centro Nazionale per la Certificazione e la Qualificazione

REPORTO DI PROVA
210202 / 1

Retrovista della base di sedile ANSI/BIFMA X5.1-2017

Dimensioni: Non richiesta
 Dimensione base richiesta: Non richiesta
 Materiali: Acciaio
 Finitura: Pulita
 Carico minimo: 150kg
 Carico massimo: 200kg
 Altezza di prova: 100mm
 Dimensione base: 100mm

ANSI/BIFMA X5.1

UL Furniture Business Division

RAPPORTO DI PROVA: 478248567.1 Rev.1

Questo rapporto analizza e certifica il prodotto in base al procedimento N° 478248567.1 secondo il 4782017.

PRODOTTORE
 Via Salaria, 56/A
 Località Col Palmiro
 San Cesareo (Lazio) - Italy

PRODOTTORE
 Base B50 - Green Test Static Anal
 Bifma X5.1-2017

PROVA
 Data: 20/11/2017
 Revisione: 01/11/2017
 Fine prova: 01/11/2017
 Revisione report: 01/11/2017

PROVA DI PROVA
 Metodo: 150kg
 Materiale: Acciaio
 Altezza: 100mm
 Dimensione base: 100mm

PROVA DI PROVA
 Metodo: 150kg
 Materiale: Acciaio
 Altezza: 100mm
 Dimensione base: 100mm

ANSI/BIFMA X5.1-2017 General Purpose Office Chairs - Tests

Questo rapporto analizza e certifica il prodotto in base al procedimento N° 478248567.1 secondo il 4782017.

PROVA DI PROVA
 Metodo: 150kg
 Materiale: Acciaio
 Altezza: 100mm
 Dimensione base: 100mm

PROVA DI PROVA
 Metodo: 150kg
 Materiale: Acciaio
 Altezza: 100mm
 Dimensione base: 100mm

ANSI/BIFMA X5.1-2017

ANSI/BIFMA X5.1

ANSI/BIFMA X5.1



tools



certification / mod. B50



certification / mod. B40

bases showing



Le basi AlbaComponents garantiscono la migliore prestazione su qualsiasi tipo di seduta, grazie agli elevati standard qualitativi con cui vengono realizzate.

Componenti fondamentali per l'appoggio a terra di ogni scocca, si contraddistinguono per la massima versatilità e assicurano un assortimento completo, in grado di rispondere alle esigenze più varie, sia in termini di design sia di funzionalità.

AlbaComponents bases guarantee outstanding performance on any chair type, thanks to the high-quality standards used in their construction.

Fundamental components for providing a firm base for all seat shells, they are characterized by maximum versatility and provide a complete range capable of meeting the most varied needs, both in terms of design and functionality.

bases

components

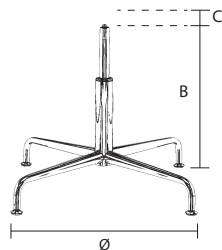

chip-base con pompa a gas assemblata completa di piedini
chip-base with gas pump assembled complete with feet

code	finishing	q.kit	q.pack	ø	b	c	kg.x1	vol.x1
110203-005	● nero/black	x1	100	650	385	90	2,90	mc. 0.02
110204-010	● grigio/grey	x1	100	650	385	90	2,90	mc. 0.02
110210-035	● cromato/chrome	x1	100	650	385	90	2,90	mc. 0.02

— altezza da terra a richiesta
height from ground on request

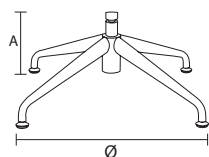

moon-base a 4 razze con meccanismo assemblato di ritorno automatico
moon-four-star base with auto-return swivel mechanism assembled

code	finishing	q.kit	q.pack	ø	a	kg.x1	vol.x1
110210-065	● cromato/chrome	x1	100	650	290	3,00	mc. 0.02

main component sizes



certification



b40-base in metallo con coprisaldatura
b40-chrome metal base + welding cover

code	finishing	q.kit	q.pack	ø	a	b	kg.x1	vol.x1
110210-027	● cromato/chrome	x1	5	640	60	11	2,85	mc. 0.014
110210-024	● cromato/chrome	x1	5	700	65	11	3,18	mc. 0.020

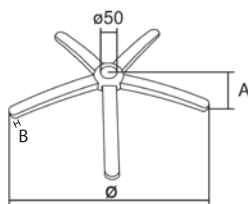

certification



b50-base a 5 razze in metallo con coprisaldatura
b50-chrome metal base + welding cover

code	finishing	q.kit	q.pack	ø	a	b	kg.x1	vol.x1
110210-057	● cromato/chrome	x1	5	640	112	11	2,25	mc. 0.0117
110210-058	● cromato/chrome	x1	5	700	118	11	2,50	mc. 0.0126

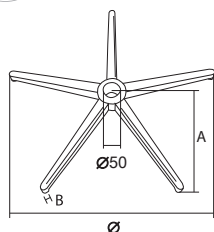

bases

components

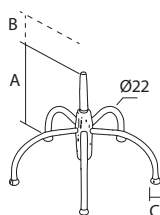

stella-base con pistone a gas assemblato completa di coprisaldatura e piedini porta ruota
 stella-base with piston with cover welding and feet for castors

code	finishing	q.kit	q.pack	a	b	c	kg.x1	vol.x1
110204-002	● grigio/grey	x1	100	360	90	Ø11	2,40	mc. 0,04
110210-020	● cromato/chrome	x1	100	360	90	Ø11	2,40	mc. 0,04

main component sizes

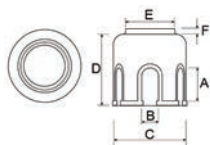
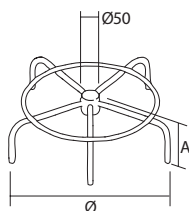
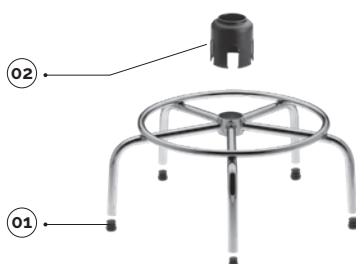

b30-base per sgabello con anello poggipiedi cono Ø50 tappi esclusi
 b30-base for stool with footrest ring cone Ø50 caps excluded

code	finishing	q.kit	q.pack	Ø	a	kg.x1	vol.x1
110210-025	● cromato/chrome	x1	80	540	200	2,55	mc. 0,02

01 puntale alettato tondo Ø20 nero
 ribbed round insert cap Ø20 black

code	finishing	q.kit
134203-200	● nero/black	x5

02 b30/csb-coprisaldatura foro d.50 nero
 b30/csb-cover welding hole d.50 black

code	finishing	q.kit	q.pack	a	b	c	d	e	kg.x1
130203-000	● nero/black	x1	150	40	20	80	87	50	0,036



BEYOND **Solutions**





components



components

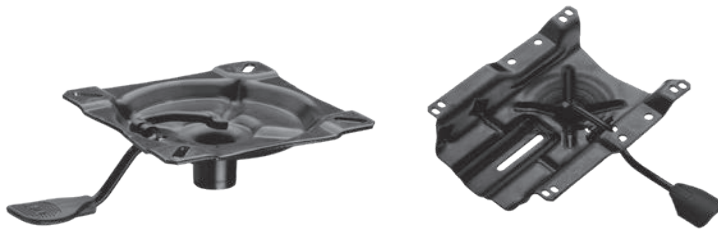

components

components showing



Una linea completa di componenti e accessori per il mondo della seduta.

Un grande numero di **soluzioni** in grado di rispondere in maniera completa e funzionale alle esigenze più varie: staffe porta braccioli, piastre con leva opzionabili con copertina in plastica per telaio girevole, meccanismo ribaltabile e braccioli in metallo (o plastica) per panca, tavolette dalle varie forme (in plastica o legno) con snodi anche dotati di meccanismo antipanico.

Tutti i **componenti e gli accessori AlbaComponents** garantiscono **design distintivo e tecnologia innovativa**, oltre ai più elevati standard qualitativi.

A complete range of components and accessories for all types of chairs.

*A large selection of highly functional **solutions** able to meet the most varied needs: armrest brackets, plates with optional lever and plastic cover for swivel frames, folding mechanisms and metal (or plastic) armrests for benches, writing tablets in various shapes (in plastic or wood) with swivel joints also equipped with anti-panic mechanisms.*

All AlbaComponents components and accessories boast distinctive designs and innovative technology, as well as a guarantee of the **highest quality standards**.

components

components

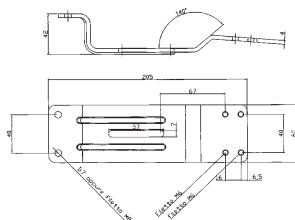

01 sb60-staffa portabracciolo
sb60-support of arm

code	finishing	q.kit	q.pack	kg.x1	vol.x1
113003-005	● nero/black	x1	50	0,50	mc. 0.0002

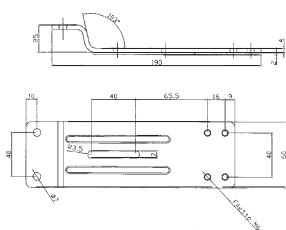

02 sb62-staffa portabracciolo
sb62-support of arm

code	finishing	q.kit	q.pack	kg.x1	vol.x1
113003-010	● nero/black	x1	50	0,50	mc. 0.0002

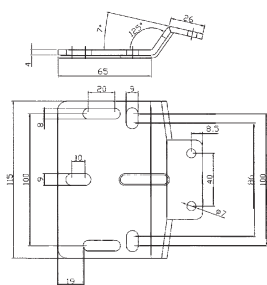

03 sb70-staffa portabracciolo
sb70-support of arm

code	finishing	q.kit	q.pack	kg.x1	vol.x1
113003-015	● nero/black	x1	50	0,40	mc. 0.0002

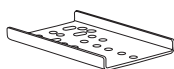

04 psaln-piastra adattatore per lama schienale
psaln-adapter plate for blade back

code	finishing	q.kit	q.pack	kg.x1	vol.x1
113003-150	● nero/black	x1	30	0,45	mc. 0.001

components

components

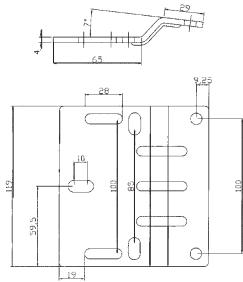

05 sb75-staffa portabraccio
sb75-support of arm

code	finishing	q.kit	q.pack	kg.x1	vol.x1
113003-017	● nero/black	x1	50	0,45	mc. 0,0002

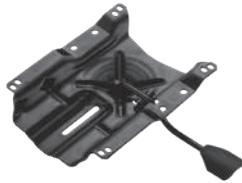
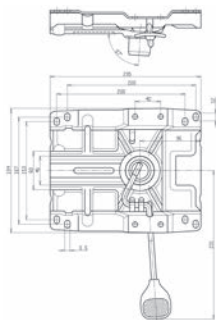

06 piastra a gas dattilo cono 28 con leva
seat place cone 28 with lever

code	finishing	q.kit	q.pack	kg.x1	vol.x1
113003-121	● nero/black	x1	20	1,23	mc. 0,002

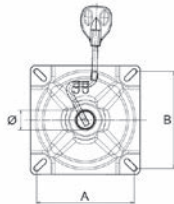

07 pss28nr - piastra sgabello c/spat. c/28 3' l4 nera
pss28nr - square metal plate with straight lever c/28 3' l4

code	finishing	q.kit	q.pack	a	b	ø	kg.x1	vol.x1
113003-104	● nero/black	x1	20	150	150	28	1,23	mc. 0,002



designed by:
stefano bettio

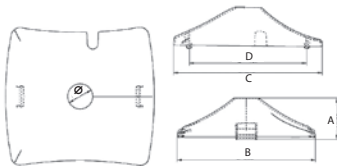

08 cpg-copertina in plastica per telaio girevole
cpg-plastic cover for swivel frame

code	finishing	q.kit	q.pack	a	b	c	d	ø	kg.x1	vol.x1
130903-000	● nero/black	x1	50	60	200	210	167	36	0,1	mc. 0,0015

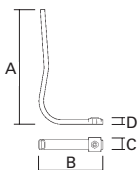

09 sh15-schienale in tubo ovale con cavalotto di rinforzo filettato
sh15-oval back with reinforcement threading black painted

code	finishing	q.kit	q.pack	a	b	c	d	kg.x1	vol.x1
112103-001	● nero/black	x1	50	330	215	30	15	0,62	mc. 0,0008

components

components

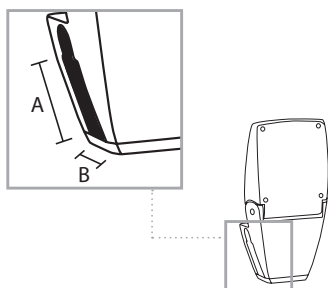

10 siton-mecanismo panca ribaltabile alluminio lucido
siton-polished aluminium folding mechanism

code	finishing	q.kit	q.pack	a	b	kg.x1	vol.x1
110704-180	○ alluminio/aluminium	x1	4	80	40	2,81	mc. 0,007



designed by:
esedra

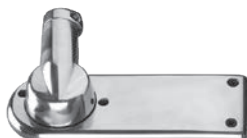

11 spta-snodo tavoletta antipanico in alluminio lucido
spta-polished aluminium swivel safety mechanism for tablet

code	finishing		q.kit	q.pack	a	b	c	kg.x1	vol.x1
111701-900	○ alluminio/aluminium	destro/right	x1	10	180	66	15x15	0,365	mc. 0,001
111701-901	○ alluminio/aluminium	sinistro/left	x1	10	180	66	15x15	0,365	mc. 0,001

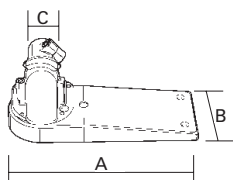

12 spt2-snodo per tavoletta in termoplastica
spt2-mechanism for writing tablet

code	finishing	q.kit	q.pack	a	b	c	kg.x1	vol.x1
134003-039	● nero/black	x1	20	180	66	15x15	0,35	mc. 0,0006

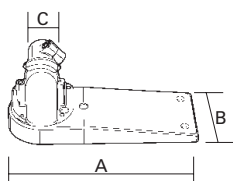

13 isoscele-aggancio laterale maschio + femmina in plastica con due viti
isoscele-plastic lateral hook male + female with 2 screws

code	finishing	q.kit	q.pack
134003-132	● nero/black	x2	100



components

components

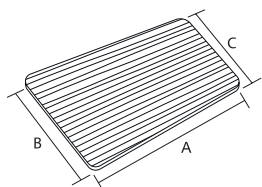

14 tlo2.cfd-tavoletta legno c/prefori dx verniciata faggio
tlo2.cfd-right painted beechwood tablet

code	finishing	q.kit	q.pack	a	b	c	kg.x1	vol.x1
120307-021	● faggio/beech	x1	10	342	245	196	0,65	mc. 0,009

tlo2.cfs-tavoletta legno c/prefori sx verniciata faggio
tlo2.cfs-left painted beechwood tablet

code	finishing	q.kit	q.pack	a	b	c	kg.x1	vol.x1
120307-022	● faggio/beech	x1	10	342	245	196	0,65	mc. 0,009

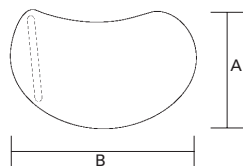

15 bean-tavoletta in termoplastico spessore 16 mm
bean-writing tablet in plastic thickness 16 mm

code	finishing	q.kit	q.pack	a	b	kg.x1	vol.x1
134003-044	● nero/black	x1	20	235	370	0,40	mc. 0,002

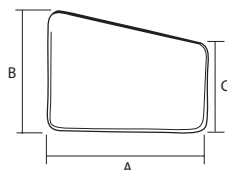

16 tlt-tavoletta in termoplastico spessore 16 mm
tlt-writing tablet in plastic thickness 16 mm

code	finishing	q.kit	q.pack	a	b	c	kg.x1	vol.x1
134003-042	● nero/black	x1	20	345	260	200	0,40	mc. 0,002

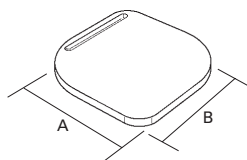

17 tlt2-tavoletta in termoplastico ovale spessore 16 mm per bracciolo destro e sinistro
tlt2-writing tablet in oval plastic thickness 16 mm for left and right arms

code	finishing	q.kit	q.pack	a	b	kg.x1	vol.x1
134003-040	● nero/black	x1	20	271	271	0,40	mc. 0,002

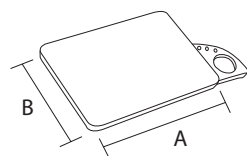

18 tlt3-tavoletta ambidestro con portabicchiere e portapenne
tlt3-writing tablet with cup holder and pen tray

code	finishing	q.kit	q.pack	a	b	kg.x1	vol.x1
134003-041	● nero/black	x1	10	370	255	1,05	mc. 0,036

bench components

components



designed by:
r&d albacomponents

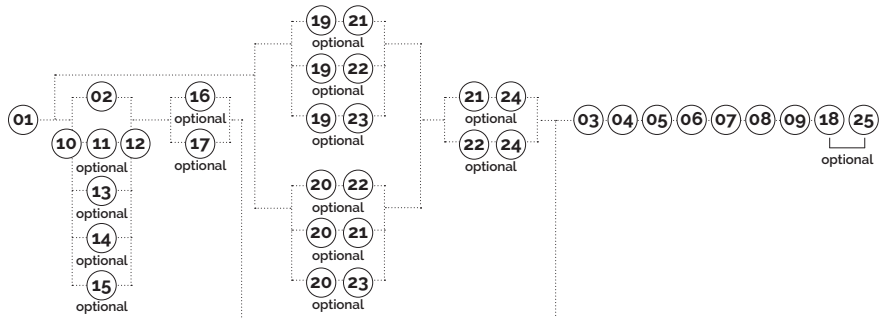
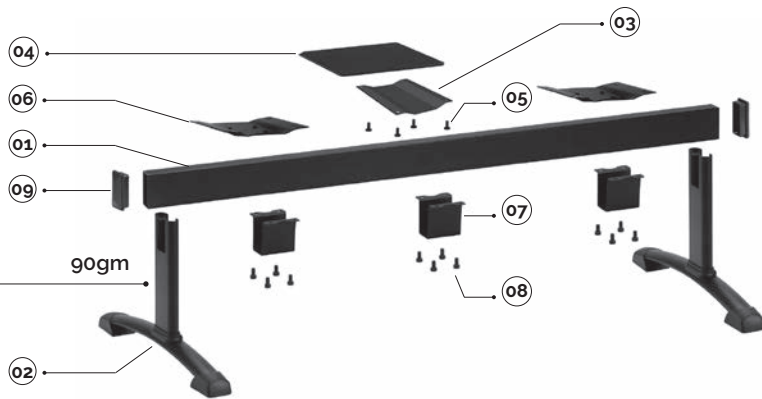

main component sizes

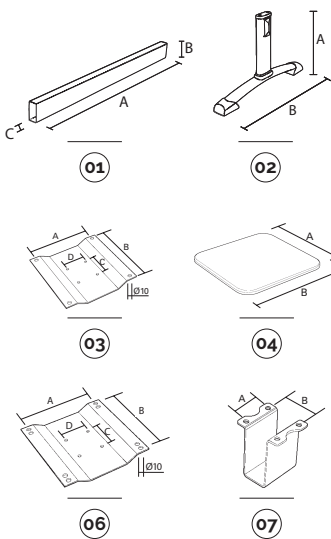

01 90t-trave per panca 90t-beam for bench

code	finishing		q.kit	q.pack	a	b	c	kg.x1	vol.x1
110703-020	● nero/black	2 posti/2 seats	x1	1	1000	80	40	2,80	mc. 0,003
110704-043	● grigio/grey	2 posti/2 seats	x1	1	1000	80	40	2,80	mc. 0,003
110703-021	● nero/black	3 posti/3 seats	x1	1	1500	80	40	4,20	mc. 0,0045
110704-044	● grigio/grey	3 posti/3 seats	x1	1	1500	80	40	4,20	mc. 0,0045
110703-022	● nero/black	4 posti/4 seats	x1	1	2000	80	40	5,60	mc. 0,006
110704-045	● grigio/grey	4 posti/4 seats	x1	1	2000	80	40	5,60	mc. 0,006
110703-023	● nero/black	5 posti/5 seats	x1	1	2500	80	40	7,00	mc. 0,0085
110704-046	● grigio/grey	5 posti/5 seats	x1	1	2500	80	40	7,00	mc. 0,0085

02 90gm-gamba mobile per panca con accessori 90gm-movable leg for bench with accessories

code	finishing		q.kit	q.pack	a	b	kg.x1	vol.x1
110703-005	● nero/black		x2	2	380	600	2,70	mc. 0,012
110704-001	● grigio/grey		x2	2	380	600	2,70	mc. 0,012
110710-001	● cromato/chrome		x2	2	380	600	2,70	mc. 0,012

03 90ap-attacco porta piano 90ap-table attachment

code	finishing		q.kit	q.pack	a	b	c	d	kg.x1	vol.x1
110703-014	● nero/black		x1	25	170	200	65	55	1,00	mc. 0,0002
110704-019	● grigio/grey		x1	25	170	200	65	55	1,00	mc. 0,0002

04 90tn-piano tavolo per panca 90tn-table for bench

code	finishing		q.kit	q.pack	a	b	kg.x1	vol.x1
120303-001	● nero/black		x1	10	400	400	2,20	mc. 0,002

05 vite tc + m6x12 brunita nera screw tc + m6x12 burnishing black

code	finishing		q.kit
117703-177	● nero/black		x4

06 92p-piastra per panca verniciata 92p-plate for bench paint

code	finishing		q.kit	q.pack	a	b	c	d	kg.x1	vol.x1
110703-013	● nero/black		x1	25	153	200	65	55	0,85	mc. 0,0008

07 90cv-cavalotto sotto trave 90cv-support under beam

code	finishing		q.kit	q.pack	a	b	kg.x1	vol.x1
110703-007	● nero/black		x1	50	55	65	0,60	mc. 0,0005
110704-015	● grigio/grey		x1	50	55	65	0,60	mc. 0,0005

08 confezione vite m8x12 testa cilindrica esagonale incassato brunita nera screw m8x12 cylindrical head hexagon embedded burnishing black package

code	finishing		q.kit	q.pack
117003-070	● nero/black		x4	200

09 tappo copritesta rettangolare 80x40 nero rectangular cover head cap 80x40 black

code	finishing		q.kit
134103-001	● nero/black		x2

bench leg & arm options

components

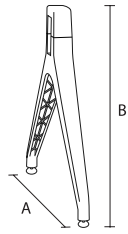

certification / Jim



EN16139

- 10 jim-gamba in plastica nera
jim-plastic bench leg_black

code	finishing	q.kit	q.pack	a	b	kg.x1	vol.x1
130703-004	● nero/black	x2	10	630	425	0,95	mc. 0,0102

- 11 jim-cavalotto x fissaggio gamba nero in plastica
jim-plastic bracket for bench leg - black

code	finishing	q.kit	q.pack	kg.x1	vol.x1
130703-005	● nero/black	x2	10	0,16	mc. 0,0005

- 12 jim-confezione accessori x 10 gambe
jim- accessories bag for 10 legs

code	finishing	q.kit	q.pack	kg.x1	vol.x1
130703-007	● nero/black	x0.2	1	0,15	mc. 0,0004

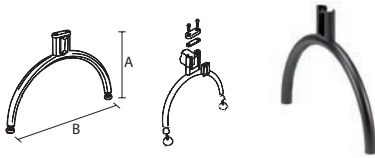

- 13 100gm-gamba mobile per panca con accessori
100gm-movable leg for bench with accessories

code	finishing	q.kit	q.pack	a	b	kg.x1	vol.x1
110703-008	● nero/black	x2	2	380	600	2,10	mc. 0,012
110704-006	● grigio/grey	x2	2	380	600	2,10	mc. 0,012
110710-005	● cromato/chrome	x2	2	380	600	2,10	mc. 0,012

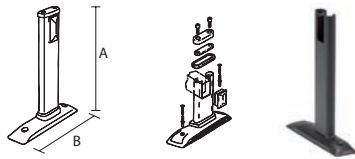

- 14 90gf-gamba fissa per panca con accessori
90gf-fixed leg for bench with accessories

code	finishing	q.kit	q.pack	a	b	kg.x1	vol.x1
110703-030	● nero/black	x2	2	380	310	1,90	mc. 0,012
110704-012	● grigio/grey	x2	2	380	310	1,90	mc. 0,012

designed by:
stefano bettio

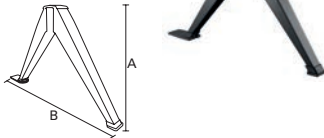

- 15 200gm-gamba mobile per panca con accessori
200gm-movable leg for bench with accessories

code	finishing	q.kit	q.pack	a	b	kg.x1	vol.x1
110703-110	● nero/black	x2	4	380	600	2,60	mc. 0,005
110704-110	● grigio/grey	x2	4	380	600	2,60	mc. 0,005
110710-110	● cromato/chrome	x2	4	380	600	2,60	mc. 0,005

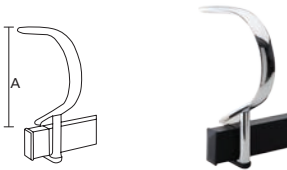

- 16 pioneer-bracciolo ellittico 40x20 per panca con accessori
pioneer-elliptical 40x20 arm for bench with accessories

code	finishing	q.kit	q.pack	a	kg.x1	vol.x1
111703-015	● nero/black	x1	5	260	1,10	mc. 0,005
111704-015	● grigio/grey	x1	5	260	1,10	mc. 0,005
111710-015	● cromato/chrome	x1	5	260	1,10	mc. 0,005

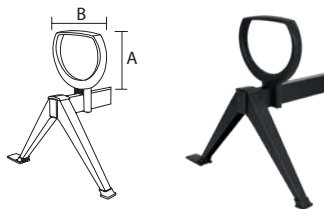

- 17 apoll-bracciolo in plastica + cavallotto per panca
apoll-plastic arm + support for bench

code	finishing	q.kit	q.pack	a	b	kg.x1	vol.x1
131703-065	● nero/black	x1	10	275	300	0,90	mc. 0,008

- 18 connettore trave panca
beam bench connector

code	finishing	q.kit	q.pack	a	b	kg.x1
110703-025	● nero/black	x1	10	75	36 400	1,42

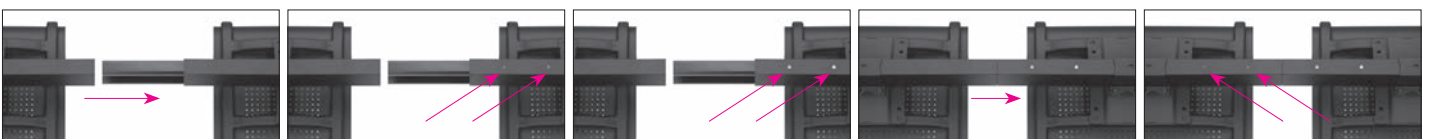
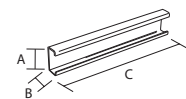

01

02

03

04

05

bench leg & arm options

components / cut & slim options



designed by:
alessandro crosera

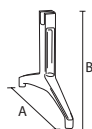

19 cut-gamba in alluminio per gamba panca + n°2 piedini
cut-aluminium leg for bench + n°2 glides

code	finishing	q.kit	q.pack	a	b	kg.x1	vol.x1
111704-224	⦿ alluminio/aluminium	x2	5	610	350	2,75	mc. 0.0132

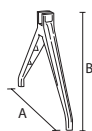

20 slim-gamba in alluminio per gamba panca + n°2 piedini
slim-aluminium leg for bench + n°2 glides

code	finishing	q.kit	q.pack	a	b	kg.x1	vol.x1
111704-226	⦿ alluminio/aluminium	x2	5	610	350	1,3125	mc. 0.0102



21 cut-bracciolo in alluminio per panca + n°2 viti
cut- aluminium arm for bench + n°2 screws

code	finishing	q.kit	q.pack	a	b	kg.x1	vol.x1
111704-223	⦿ alluminio/aluminium	x1	10	300	305	1,6065	mc. 0.0028



22 slim-bracciolo in alluminio per panca + n°2 viti
slim- aluminium arm for bench + n°2 screws

code	finishing	q.kit	q.pack	a	b	kg.x1	vol.x1
111704-225	⦿ alluminio/aluminium	x1	10	325	305	1,464	mc. 0.0049



23 cut/slim-cavalotto in alluminio per gamba panca + n°2 viti
cut/slim aluminium bracket 80x40 for bench leg + n°2 screws

code	finishing	q.kit	q.pack	a	b	kg.x1	vol.x1
111704-222	⦿ alluminio/aluminium	x2	10	60	95	0,30	mc. 0.0005

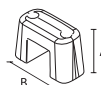

24 cut/slim-cavalotto in alluminio per bracciolo panca
cut/slim aluminium bracket 80x40 for bench arm

code	finishing	q.kit	q.pack	a	b	kg.x1	vol.x1
111704-221	⦿ alluminio/aluminium	x1	10	58	95	0,38	mc. 0.0005

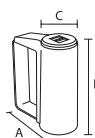

25 e:usb-caricatore per panca
e:usb-bench plug

code	finishing	q.kit	q.pack	a	b	c	kg.x1	vol.x1
130703-002	● nero/black	x1	5	85	100	38	0,28	mc. 0.0009

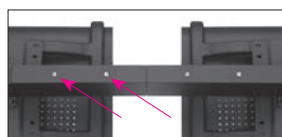

06



07

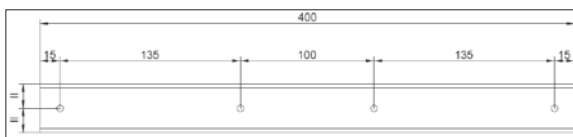

trama di foratura consigliata, lato inferiore trave
hole pattern suggested, underneath side of the beam

A D V A N C E D

Catalogue
2021

albacomponents

art direction & design

sevenmedialab

photo

photopiù

print

graficasette



download here
Advanced Catalogue

albacomponents



albacomponents.it

AlbaComponents by Metalmeccanica Alba srl

via Boschier, 54/A
Loc. Ca' Rainati
31020 San Zenone degli Ezzelini
TREVISO (Italy)

Tel +39.0423.969700 r.a.
Fax +39.0423.964014
info@albacomponents.it
www.albacomponents.it