



lemon



lemon

outdoor experience



Disegnato da
Pio e Tito Toso

*Designed by
Pio and Tito Toso*



La sedia con telaio 4 gambe è certificata
• ANSI-BIFMA X5.4-2020
• EN 16139:2013+AC2013 2nd level

*The 4-leg frame chair is certified
• ANSI-BIFMA X5.4-2020
• EN 16139:2013+AC2013 2nd level*





Lemon è una completa collezione di sedute e tavoli, ideali per contesti di utilizzo outdoor, ma non solo.

La collezione è offerta in una curata selezione di colori e finiture, sia nelle versioni sedia che sgabello, sia nell'ampia gamma di tavoli e tavolini.

Lemon is a complete collection of seats and tables, ideal for outdoor use, but more than that.

The collection is offered in a refined and contemporary selection of colors and finishes, in both chair and stool versions, as well as in the wide range of tables.



La versione sedia è disponibile con o senza braccioli, e presenta un peculiare e distintivo design. Sedile e schienale sono infatti costituiti da 5 singole doghe in tecnopolimero.

Le doghe sono fissate al telaio senza alcuna vite a vista, enfatizzando la cura del dettaglio e le linee pulite ed essenziali della sedia.

The chair version is available with or without armrests, and features a characteristic and distinctive design. Seat and backrest are in fact made of 5 individual technopolymer staves.

The staves are attached to the frame without any visible screws, emphasising the chair's clean and essential lines.









Anche la versione sgabello mantiene il caratteristico design a doghe, ed è proposta con telai di due differenti altezze, entrambi impilabili e disponibili nelle 6 colorazioni della collezione.

The stool version also retains the characteristic staved design, and is offered with frames in two different heights, both stackable and available in the collection's six colours.



La sedia con telaio 4 gambe è certificata

- ANSI-BIFMA X5.4-2020
- EN 16139:2013+AC2013 2nd level

The 4-leg frame chair is certified

- ANSI-BIFMA X5.4-2020
- EN 16139:2013+AC2013 2nd level



Lemon, nella versione sedia, con e senza braccioli, e nella versione sgabello, consente una comoda impilabilità. La presenza di appositi distanziatori fissati sotto il telaio impedisce che le doghe in tecnopolimero possano danneggiarsi quando impilate.

Inoltre, la forma del telaio crea una solida e pratica maniglia nella parte superiore dello schienale, ideale per facilitare le operazioni di movimentazione della sedia. Questa caratteristica si presenta anche nelle versioni sgabello.

Lemon, in the chair version, with and without armrests, and in the stool version, allows for convenient stacking. The presence of special spacers fixed under the frame prevents the technopolymer slats from being damaged when stacked.

In addition, the shape of the frame creates a solid and practical handle at the top of the backrest, ideal for facilitating chair handling. This feature also appears in the stool versions.





Le sedute Lemon vengono affiancate da un'ampia gamma di tavoli, disponibili in diversi formati, dimensioni e colori, proposti con due differenti tipologie di piani: in HPL o in metallo. La struttura a tre gambe, oltre che esteticamente distintiva, è pratica da imballare e facilmente assemblabile.

The Lemon chairs are complemented by a wide range of tables, available in different formats, sizes and colours, offered with two different types of tops: HPL or metal. The three-legged structure is not only aesthetically distinctive, but also convenient to pack and easy to assemble.



I tavoli Lemon, nei formati a base centrale, nelle dimensioni media e alta, sono disponibili anche in una versione con piano ribaltabile. Questa funzionalità, associata alla struttura a tre gambe, permette di raggiungere una ottimale impilabilità orizzontale dei tavoli.

The Lemon tables, in medium and high heights with a central base, are also available in a version with a folding top. This feature, combined with the three-legged structure, allows for optimal horizontal stacking of the tables.







La cura del dettaglio della collezione si ritrova anche nelle strutture dei tavoli, con un piedino dal design in grado di dare completa continuità alla linea della gamba, e con la presenza di una cover in tecnopolimero nella parte di giunzione centrale delle tre gambe.

The collection's attention to detail can also be found in the table structures, with a foot design that gives complete continuity to the line of the leg, or with the presence of a technopolymer cover in the central joint of the three legs.



lemon

chair/stool finishings

telai/frames
outdoor-indoor

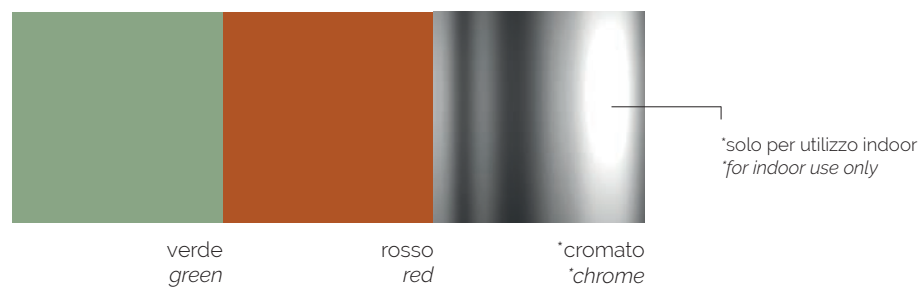

doghe/staves
outdoor-indoor

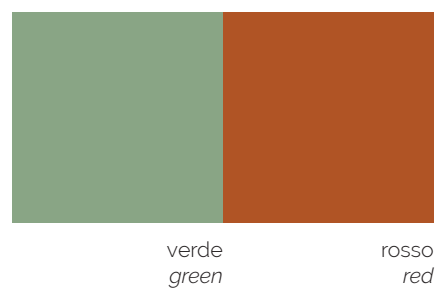

lemon

table finishings

strutture/structures
outdoor-indoor

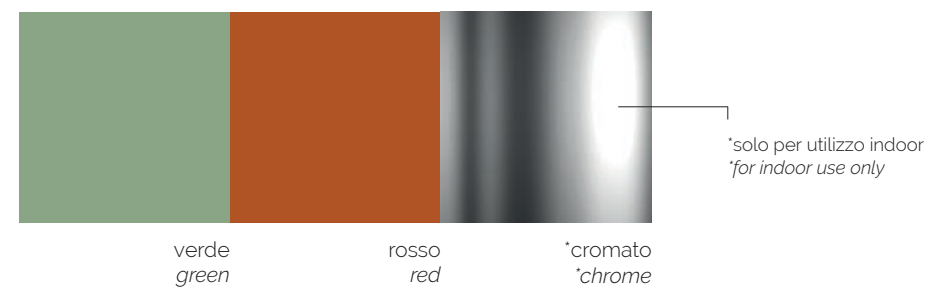

top in metallo/metal top
outdoor-indoor

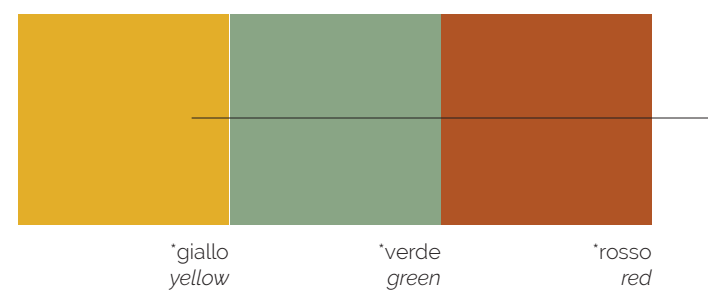
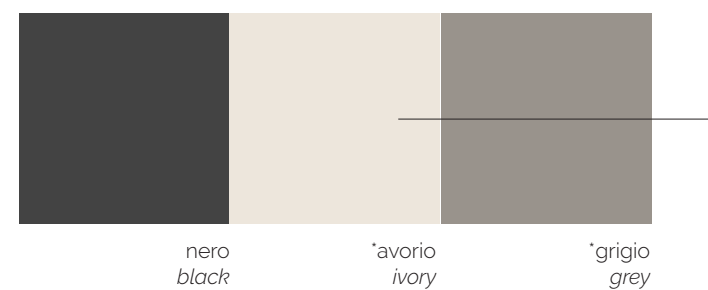

top in hpl/hpl top
outdoor-indoor

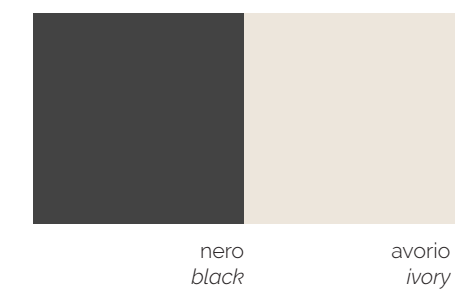

lemon

kit components

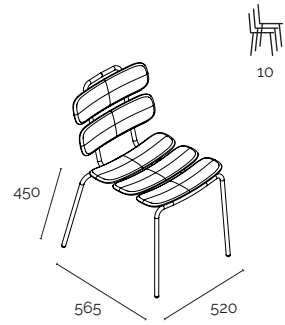

4-legs

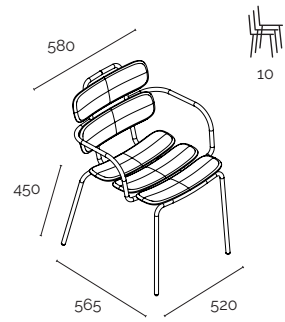
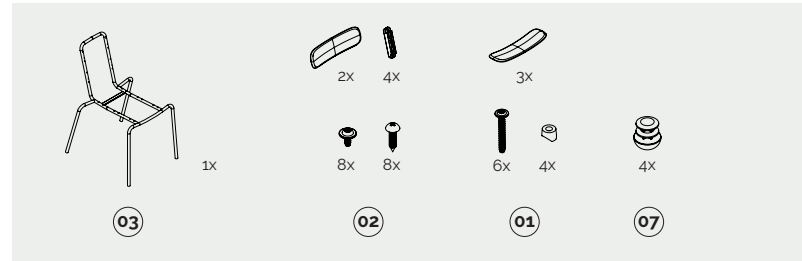

4-legs with armrests

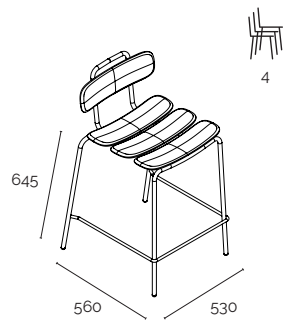
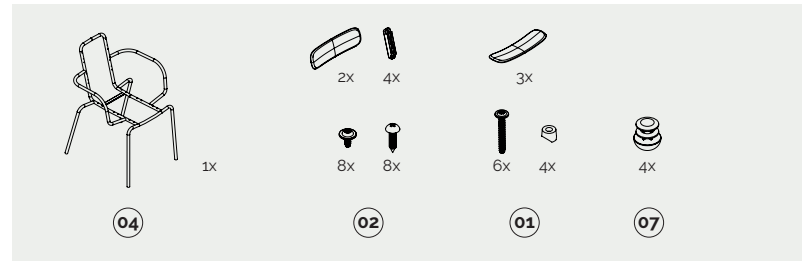

stool h.650

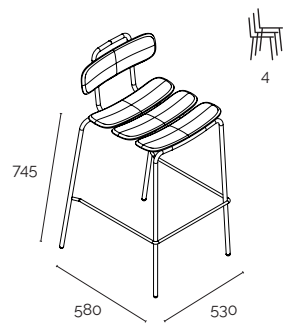
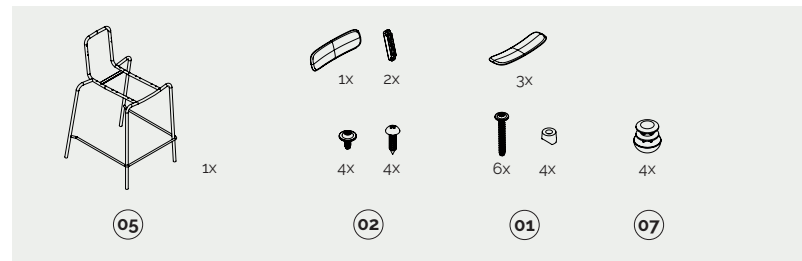

stool h.750

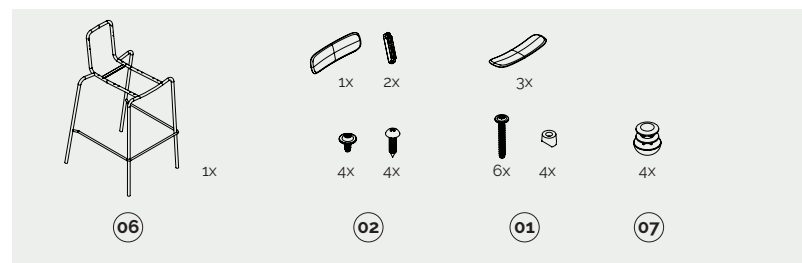

lemon

kit components

medium table

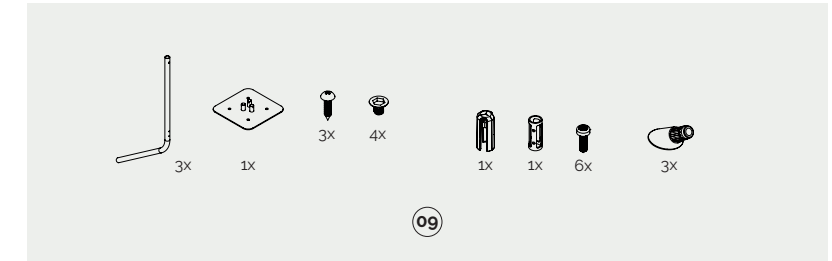
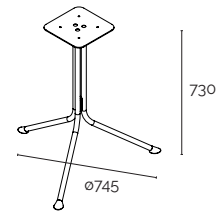

high table

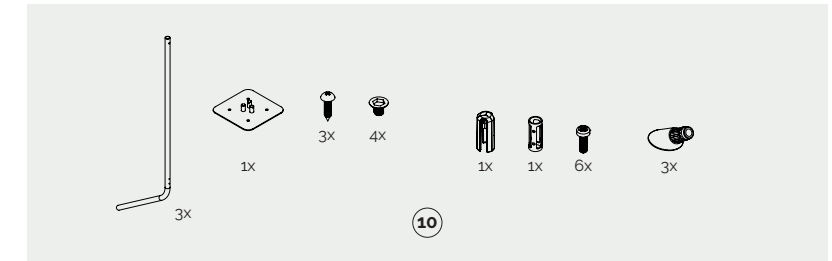
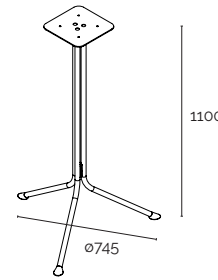

tilting medium table

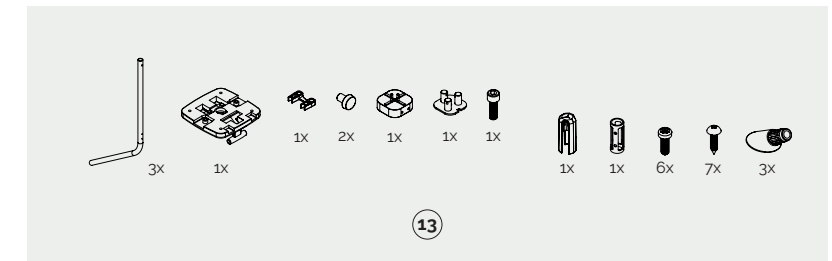
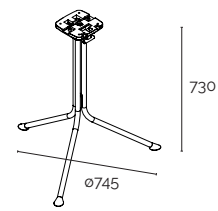

tilting high table

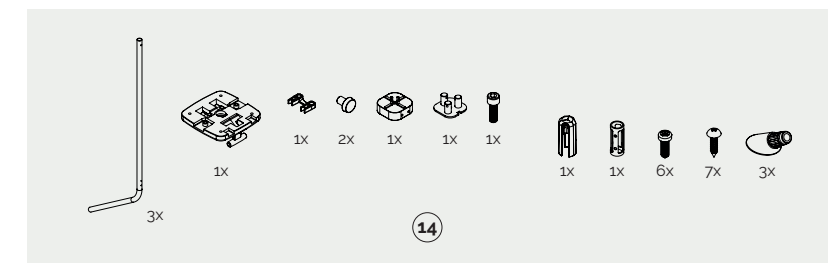
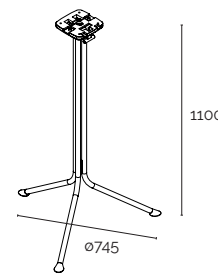

lemon

kit components

coffee table

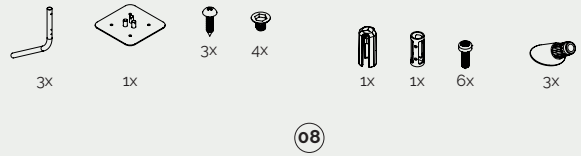
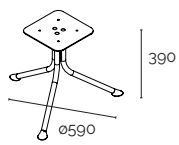

08

rectangular medium table

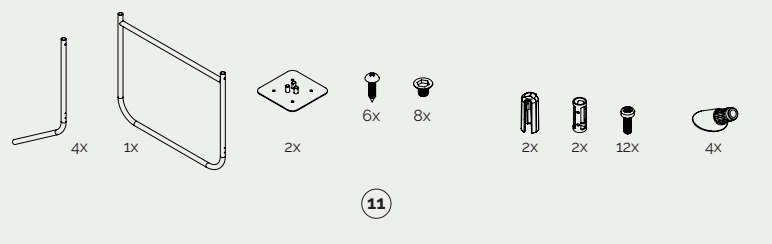
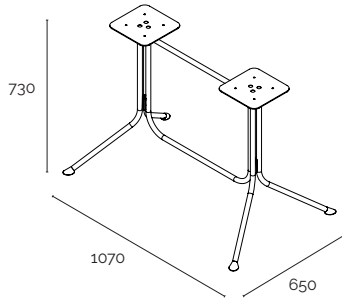

11

rectangular high table

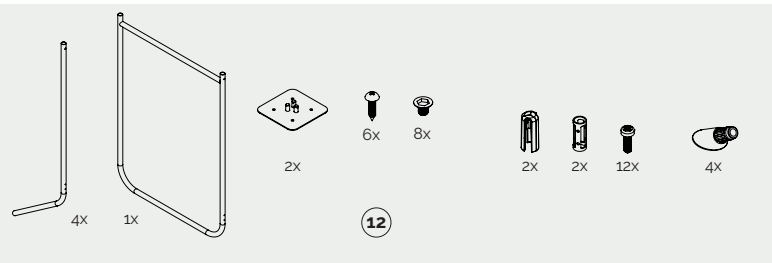
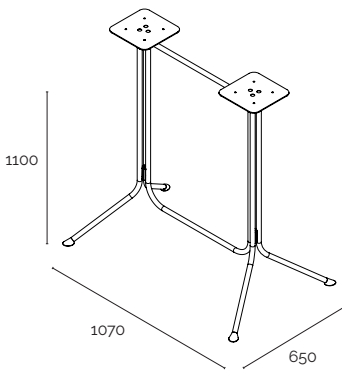

12

lemon

table tops selection

hpl round top ø590

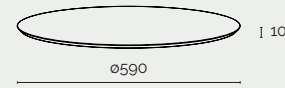

17

metal round top ø600

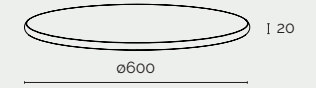

22

hpl round top ø690

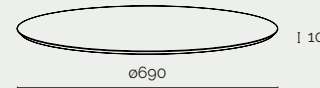

18

metal round top ø700



23

hpl square top 590 x 590

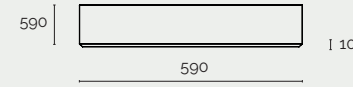

19

metal square top 590 x 590

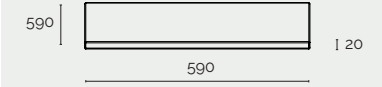

24

hpl square top 690 x 690

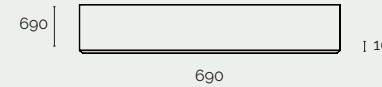

20

metal square top 690 x 690

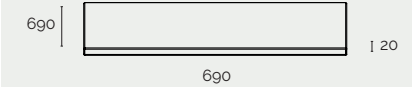

25

hpl rectangular top 1190 x 690

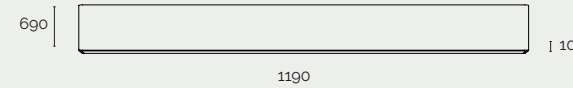

21

metal rectangular top 1190 x 690

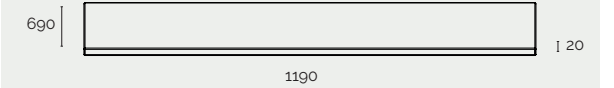

26

lemon

components

segue/follow tavoli/tables

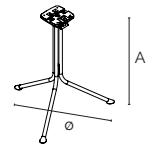

13 lemon - struttura tavolino medio ribaltabile lemon - tilting medium table structure

code	finishing		q.kit	q.pack	Ø	a	kg.x1	vol.x1
110303-675	● nero/black	outdoor/indoor	x1	1	745	730	4,30	mc. 0.0186
110305-675	● avorio ragg. opaco/ivory rough matt	outdoor/indoor	x1	1	745	730	4,30	mc. 0.0186
110304-675	● grigio ragg. opaco/grey rough matt	outdoor/indoor	x1	1	745	730	4,30	mc. 0.0186
110308-675	● giallo ragg./yellow rough	outdoor/indoor	x1	1	745	730	4,30	mc. 0.0186
110316-675	● verde opaco liscio/green glossy matt	outdoor/indoor	x1	1	745	730	4,30	mc. 0.0186
110302-675	● rosso/red	outdoor/indoor	x1	1	745	730	4,30	mc. 0.0186
110310-675	● cromato/chrome	indoor	x1	1	745	730	4,30	mc. 0.0186

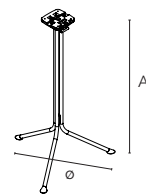

14 lemon - struttura tavolino alto ribaltabile lemon - tilting high table structure

code	finishing		q.kit	q.pack	Ø	a	kg.x1	vol.x1
110303-676	● nero/black	outdoor/indoor	x1	1	745	1100	5,30	mc. 0.0272
110305-676	● avorio ragg. opaco/ivory rough matt	outdoor/indoor	x1	1	745	1100	5,30	mc. 0.0272
110304-676	● grigio ragg. opaco/grey rough matt	outdoor/indoor	x1	1	745	1100	5,30	mc. 0.0272
110308-676	● giallo ragg./yellow rough	outdoor/indoor	x1	1	745	1100	5,30	mc. 0.0272
110316-676	● verde opaco liscio/green glossy matt	outdoor/indoor	x1	1	745	1100	5,30	mc. 0.0272
110302-676	● rosso/red	outdoor/indoor	x1	1	745	1100	5,30	mc. 0.0272
110310-676	● cromato/chrome	indoor	x1	1	745	1100	5,30	mc. 0.0272

15 lemon - kit maniglia + 2 agganci in plastica neri (per tavolo ribaltabile) lemon - kit black plastic handle + 2 hooks (for folding table structure)

code	finishing		q.kit	q.pack
130303-025	● nero/black		x1	1

16 lemon - piastra per kit maniglia + agganci con piano in metallo lemon - sheet metal for kit black plastic handle + hooks with metal top

code	finishing		q.kit	q.pack
113003-140	● nero/black		x1	10

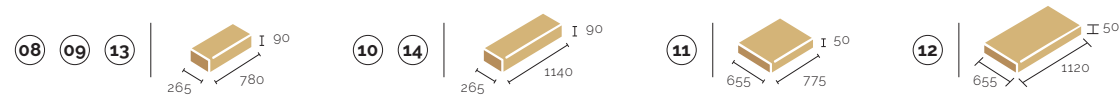

piani tavoli in hpl/hpl tables top

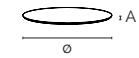

17 lemon - top rotondo Ø590 lemon - round top Ø590

code	finishing		q.kit	q.pack	Ø	a	kg.x1	vol.x1
120303-021	● nero/black	outdoor/indoor	x1	1	590	10	4,00	mc. 0.0072
120305-021	● avorio/ivory	outdoor/indoor	x1	1	590	10	4,00	mc. 0.0072

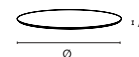

18 lemon - top rotondo Ø690 lemon - round top Ø690

code	finishing		q.kit	q.pack	Ø	a	kg.x1	vol.x1
120303-022	● nero/black	outdoor/indoor	x1	1	690	10	5,70	mc. 0.0098
120305-022	● avorio/ivory	outdoor/indoor	x1	1	690	10	5,70	mc. 0.0098

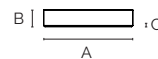

19 lemon - top quadrato 590x590 lemon - square top 590x590

code	finishing		q.kit	q.pack	a	b	c	kg.x1	vol.x1
120303-024	● nero/black	outdoor/indoor	x1	1	590	590	10	5,70	mc. 0.0072
120305-024	● avorio/ivory	outdoor/indoor	x1	1	590	590	10	5,70	mc. 0.0072

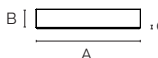

20 lemon - top quadrato 690x690 lemon - square top 690x690

code	finishing		q.kit	q.pack	a	b	c	kg.x1	vol.x1
120303-025	● nero/black	outdoor/indoor	x1	1	690	690	10	7,80	mc. 0.0098
120305-025	● avorio/ivory	outdoor/indoor	x1	1	690	690	10	7,80	mc. 0.0098

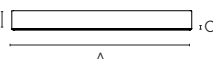

21 lemon - top rettangolare 1190x690 lemon - rectangular top 1190x690

code	finishing		q.kit	q.pack	a	b	c	kg.x1	vol.x1
120303-020	● nero/black	outdoor/indoor	x1	1	1190	690	10	13,5	mc. 0.0168
120305-020	● avorio/ivory	outdoor/indoor	x1	1	1190	690	10	13,5	mc. 0.0168

lemon

components

piani tavoli in metallo/metal tables top

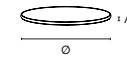

22 lemon - top in metallo rotondo Ø600 lemon - metal round top Ø600

code	finishing		q.kit	q.pack	Ø	a	kg.x1	vol.x1
110303-694	● nero/black	outdoor/indoor	x1	1	600	20	5,80	mc. 0.0072
110305-694	● avorio ragg. opaco/ivory rough matt'	outdoor/indoor	x1	1	600	20	5,80	mc. 0.0072
110304-694	● grigio ragg. opaco/grey rough matt'	outdoor/indoor	x1	1	600	20	5,80	mc. 0.0072
110308-694	● giallo ragg./yellow rough'	outdoor/indoor	x1	1	600	20	5,80	mc. 0.0072
110316-694	● verde opaco liscio/green glossy matt'	outdoor/indoor	x1	1	600	20	5,80	mc. 0.0072
110302-694	● rosso/red'	outdoor/indoor	x1	1	600	20	5,80	mc. 0.0072

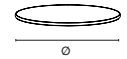

23 lemon - top in metallo rotondo Ø700 lemon - metal round top Ø700

code	finishing		q.kit	q.pack	Ø	a	kg.x1	vol.x1
110303-695	● nero/black	outdoor/indoor	x1	1	700	20	7,70	mc. 0.0098
110305-695	● avorio ragg. opaco/ivory rough matt'	outdoor/indoor	x1	1	700	20	7,70	mc. 0.0098
110304-695	● grigio ragg. opaco/grey rough matt'	outdoor/indoor	x1	1	700	20	7,70	mc. 0.0098
110308-695	● giallo ragg./yellow rough'	outdoor/indoor	x1	1	700	20	7,70	mc. 0.0098
110316-695	● verde opaco liscio/green glossy matt'	outdoor/indoor	x1	1	700	20	7,70	mc. 0.0098
110302-695	● rosso/red'	outdoor/indoor	x1	1	700	20	7,70	mc. 0.0098



24 lemon - top in metallo quadrato 590x590 lemon - metal square top 590x590

code	finishing		q.kit	q.pack	a	b	c	kg.x1	vol.x1
110303-696	● nero/black	outdoor/indoor	x1	1	590	590	20	7,45	mc. 0.0072
110305-696	● avorio ragg. opaco/ivory rough matt'	outdoor/indoor	x1	1	590	590	20	7,45	mc. 0.0072
110304-696	● grigio ragg. opaco/grey rough matt'	outdoor/indoor	x1	1	590	590	20	7,45	mc. 0.0072
110308-696	● giallo ragg./yellow rough'	outdoor/indoor	x1	1	590	590	20	7,45	mc. 0.0072
110316-696	● verde opaco liscio/green glossy matt'	outdoor/indoor	x1	1	590	590	20	7,45	mc. 0.0072
110302-696	● rosso/red'	outdoor/indoor	x1	1	590	590	20	7,45	mc. 0.0072

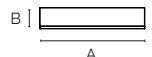

25 lemon - top in metallo quadrato 690x690 lemon - metal square top 690x690

code	finishing		q.kit	q.pack	a	b	c	kg.x1	vol.x1
110303-697	● nero/black	outdoor/indoor	x1	1	690	690	20	9,70	mc. 0.0098
110305-697	● avorio ragg. opaco/ivory rough matt'	outdoor/indoor	x1	1	690	690	20	9,70	mc. 0.0098
110304-697	● grigio ragg. opaco/grey rough matt'	outdoor/indoor	x1	1	690	690	20	9,70	mc. 0.0098
110308-697	● giallo ragg./yellow rough'	outdoor/indoor	x1	1	690	690	20	9,70	mc. 0.0098
110316-697	● verde opaco liscio/green glossy matt'	outdoor/indoor	x1	1	690	690	20	9,70	mc. 0.0098
110302-697	● rosso/red'	outdoor/indoor	x1	1	690	690	20	9,70	mc. 0.0098

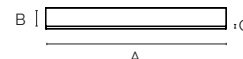

26 lemon - top in metallo rettangolare 1190x690 lemon - metal rectangular top 1190x690

code	finishing		q.kit	q.pack	a	b	c	kg.x1	vol.x1
110303-698	● nero/black	outdoor/indoor	x1	1	1190	690	20	17,80	mc. 0.0168
110305-698	● avorio ragg. opaco/ivory rough matt'	outdoor/indoor	x1	1	1190	690	20	17,80	mc. 0.0168
110304-698	● grigio ragg. opaco/grey rough matt'	outdoor/indoor	x1	1	1190	690	20	17,80	mc. 0.0168
110308-698	● giallo ragg./yellow rough'	outdoor/indoor	x1	1	1190	690	20	17,80	mc. 0.0168
110316-698	● verde opaco liscio/green glossy matt'	outdoor/indoor	x1	1	1190	690	20	17,80	mc. 0.0168
110302-698	● rosso/red'	outdoor/indoor	x1	1	1190	690	20	17,80	mc. 0.0168

*colori disponibili solo in quantità minima d'ordine
*colours only available in minimum order quantities



download here
Lemon Catalogue

alba.

alba.it

Alba is a brand by Metalmeccanica Alba srl

via Boschier, 54/A
31020 San Zenone degli Ezzelini (TV)
info@alba.it
T. +39 0423 969700