



magix



magix



slide

4 legs

4 legs with castors

swivel

bench



EN 16139

magix showing



tools



certification



La seduta dai caratteristici e confortevoli braccioli strutturali.

Un telaio tubolare in metallo dal design assolutamente distintivo, previsto in varie finiture. Disponibili inoltre diverse versioni dello schienale: tradizionale, alto o basso, da tappezzare o trapezoidale da tappezzare, in rete o plastica a vista. Grazie alla vasta gamma di componenti, due tipi di braccioli a scelta e due opzioni di sedile, **Magix** è adattabile a un ampio numero di telai per un assortimento completo.

Plus:

- vasta gamma di componenti sia per lo schienale sia per il sedile;
- estremamente versatile e completa.

Magix è la soluzione ideale per **ambiente conference, meeting room** o per il **front office**.

The chair featuring distinctive and comfortable structural armrests.

A tubular metal frame with a highly distinctive design, available in a range of finishes. Different versions of the backrest are also available: traditional, high or low, to be upholstered or trapezoidal to be upholstered, in mesh or bare plastic. Thanks to the wide range of components, choice of two types of armrest and two seat options, **Magix** can be adapted to a large number of frames to provide an extensive range of options.

Advantages:

- wide range of components for both the backrest and the seat;
- extremely versatile and complete.

Magix is the ideal solution for **conference and meeting room environments** or for **front offices**.

magix

slide



CERTIFIED BY
CATAS

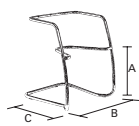
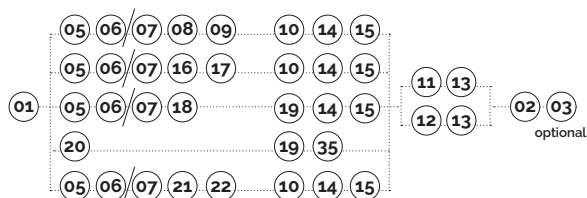

01

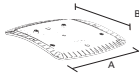

05



06



07

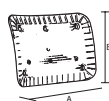

08

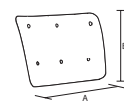

09

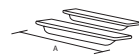

11



03



01 magix-base a slitta in tubo asform d.25 tappi esclusi
magix-slide frame pipe d.25 without caps

code	finishing	q.kit	q.pack	a	b	c	kg.x1	vol.x1
110503-009	● nero/black	x1	48	450	560	560	4,90	mc. 0,045
110504-112	● grigio/grey	x1	48	450	560	560	4,90	mc. 0,045
110510-095	● cromato/chrome	x1	48	450	560	560	4,90	mc. 0,045

02 magix-confezione accessori 50 picma + 290 p2pa
magix-pack of accessories 50 picma + 290 p2pa

code	finishing	q.kit	q.pack	kg.x1	vol.x1
137000-009	● nero/black	x1x6	50+290	1,00	mc. 0,1413

03 piedino antibaltamento in plastica nero + viti
plastic black feet anti-upsetting + screws

code	finishing	q.kit	q.pack	kg.x1	vol.x1
134303-006	● nero/black	x2	100	0,025	mc. 0,0001

05 magix sdi-sedile interno plastica nero
magix sdi-black plastic inner seat

code	finishing	q.kit	q.pack	a	b	kg.x1	vol.x1
132203-035	● nero/black	x1	10	480	460	1,10	mc. 0,045

06 magix sde-sedile esterno plastica nero
magix sde-black plastic external seat

code	finishing	q.kit	q.pack	a	b	kg.x1	vol.x1
132203-036	● nero/black	x1	20	450	420	0,34	mc. 0,051

07 magix sde-sedile esterno plastica nero per slitta
magix sde-black plastic external seat for slide frame

code	finishing	q.kit	q.pack	a	b	kg.x1	vol.x1
132203-037	● nero/black	x1	20	450	420	0,436	mc. 0,051

08 magix shi-schienale interno plastica nero
magix shi-black plastic inner back

code	finishing	q.kit	q.pack	a	b	kg.x1	vol.x1
132103-040	● nero/black	x1	20	470	290	0,95	mc. 0,004

09 magix she-schienale esterno plastica nero
magix she-black plastic external back

code	finishing	q.kit	q.pack	a	b	kg.x1	vol.x1
132103-041	● nero/black	x1	20	470	290	0,26	mc. 0,055

11 bracciolo destro e sinistro plastica nero
left right black plastic arm

code	finishing	q.kit	q.pack	a	kg.x1	vol.x1
131703-040	● nero/black	x2	100	200	0,04	mc. 0,0004

13 confezioni viti trucioliari tsp+ d.4x25 zincate (per fissare braccioli)
shaving screws tsp+ d.4x25 zinc package (for arms)

code	finishing	q.kit	q.pack
117011-072	○ zincata/zinc	x4	200

14 confezione viti tbl+ fr. d.5x14 brunita nera
screws tbl+ fr.hilo d.5x14 burnished black package

code	finishing	q.kit	q.pack
117003-071	● nero/black	x6	200

15 vite tsp+m6x35 zincata per il sedile
screw tsp+m6x35 zinc for the seat

code	finishing	q.kit
117711-183	○ zincata/zinc	x4

10 vite tspcei m6x40
screw tspcei m6x40

code	finishing	q.kit
117711-250	○ zincata/zinc	x3

main component sizes

optipnals

magix

slide/armrest option

main component sizes

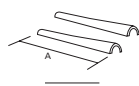

12



12 bracciolo destro e sinistro plastica conico
left right black plastic conic arm

code	finishing	q.kit	q.pack	a	kg.x1	vol.x1
131703-041	● nero/black	x2	200	205	0,04	mc. 0.0002

slide/backrest and seat options

main component sizes

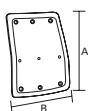

16



16 magix shi-schienale interno alto plastica nero
magix shi-inside black plastic inner back

code	finishing	q.kit	q.pack	a	b	kg.x1	vol.x1
132103-043	● nero/black	x1	20	540	450	1,80	mc. 0.0055

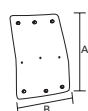

17

17 magix she-schienale alto esterno plastica nero
magix she-black plastic external high back

code	finishing	q.kit	q.pack	a	b	kg.x1	vol.x1
132103-042	● nero/black	x1	20	540	450	0,50	mc. 0.0069

and · **10** **14** **15** **13**

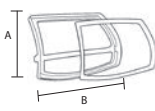

18



18 schienale e cornice per rete urban
outer back and open frame for urban net

code	finishing	q.kit	q.pack	a	b	kg.x1	vol.x1
132103-037	● nero/black	x1	10	288	453	0,98	mc. 0.015

19 vite tspcei m6x35
screw tspcei m6x35

code	finishing	q.kit
117711-180	○ zincata/zinc	x3

and · **14** **15** **13**

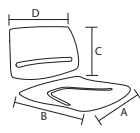

20



20 sedile e schienale a vista urban
seat and back sight urban

code	finishing	q.kit	q.pack	a	b	c	d	kg.x1	vol.x1
134003-112	● nero/black	x1	10	452	425	288	453	2,5	mc. 0.016
134004-112	● grigio/grey	x1	10	452	425	288	453	2,5	mc. 0.016
134005-112	○ bianco/white	x1	10	452	425	288	453	2,5	mc. 0.016

19 vite tspcei m6x35
screw tspcei m6x35

code	finishing	q.kit
117711-180	○ zincata/zinc	x3

35 vite autoflettante ts* 5,5x38 zincata
screw autothreading ts* 5,5x38 flared cross

code	finishing	q.kit
117811-165	○ zincata/zinc	x4

and · **13**

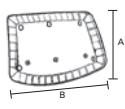

21



21 schienale interno urban
inner back urban

code	finishing	q.kit	q.pack	a	b	kg.x1	vol.x1
132103-039	● nero/black	x1	20	450	540	0,77	mc. 0.006

22 schienale esterno urban
outer back urban

code	finishing	q.kit	q.pack	a	b	kg.x1	vol.x1
132103-038	● nero/black	x1	20	450	540	0,24	mc. 0.006

and · **10** **14** **15** **13**

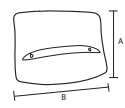

22

magix

4-legs

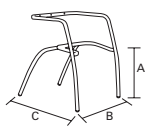
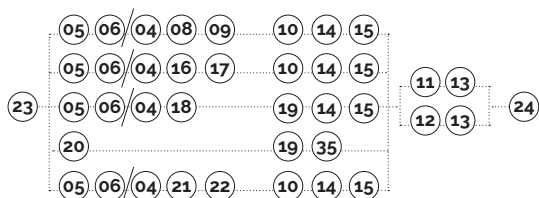
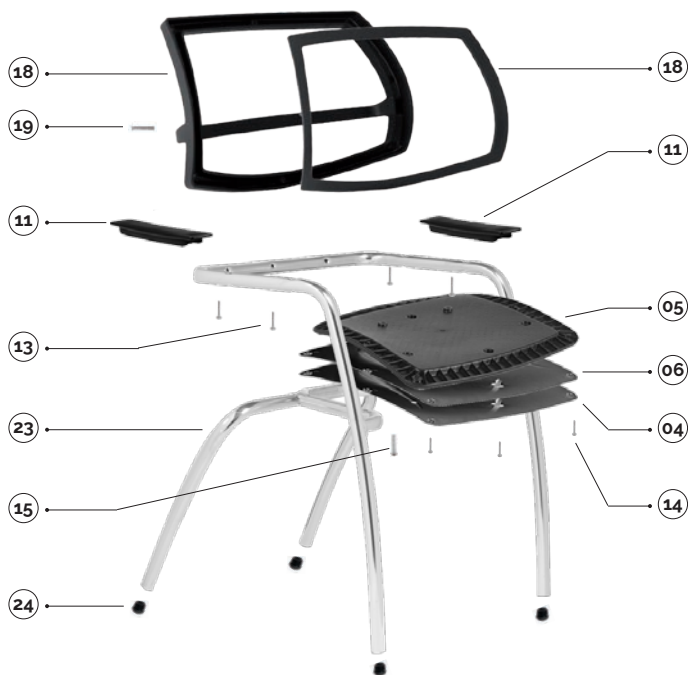

23

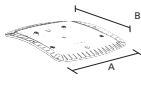

05



06



04



18

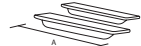

11

main component sizes

23 magix-telaio quattro gambe d.25 senza tappi
magix-four legs frame d.25 without caps

code	finishing	q.kit	q.pack	a	b	c	kg.x1	vol.x1
110103-006	● nero/black	x1	30	450	550	550	4.10	mc. 0.045
110104-006	● grigio/grey	x1	30	450	550	550	4.10	mc. 0.045
110110-006	● cromato/chrome	x1	30	450	550	550	4.10	mc. 0.045

24 confezione puntali a testa sferica d.25
cap d.25 spherical head black package

code	finishing	q.kit	q.pack
137003-075	● nero/black	x4	120

05 magix sdi-sedile interno plastica nero
magix sdi-black plastic inner seat

code	finishing	q.kit	q.pack	a	b	kg.x1	vol.x1
132203-035	● nero/black	x1	10	480	460	1.10	mc. 0.045

06 magix sde-sedile esterno plastica nero
magix sde-black plastic external seat

code	finishing	q.kit	q.pack	a	b	kg.x1	vol.x1
132203-036	● nero/black	x1	20	450	420	0.34	mc. 0.051

04 magix sde-sedile esterno plastica nero per telaio 4 gambe
magix sde-black plastic external seat for 4-legs frame

code	finishing	q.kit	q.pack	a	b	kg.x1	vol.x1
132203-038	● nero/black	x1	20	450	420	0.452	mc. 0.051

18 schienale e cornice per rete urban
outer back and open frame for urban net

code	finishing	q.kit	q.pack	a	b	kg.x1	vol.x1
132103-037	● nero/black	x1	10	288	453	0.98	mc. 0.015

11 bracciolo destro e sinistro plastica nero
left right black plastic arm

code	finishing	q.kit	q.pack	a	kg.x1	vol.x1
131703-040	● nero/black	x2	100	200	0.04	mc. 0.0004

13 confezioni viti trucioliari tsp+ d.4x25 zincate (per fissare braccioli)
shaving screws tsp+ d.4x25 zinc package (for arms)

code	finishing	q.kit	q.pack
117011-072	○ zincata/zinc	x4	200

14 confezione viti tbl+ fr. d.5x14 brunita nera
screws tbl+ fr.hilo d.5x14 burnished black package

code	finishing	q.kit	q.pack
117003-071	● nero/black	x6	200

15 vite tsp+m6x35 zincata per il sedile
screw tsp+m6x35 zinc for the seat

code	finishing	q.kit
117711-183	○ zincata/zinc	x4

19 vite tspcei m6x35
screw tspcei m6x35

code	finishing	q.kit
117711-180	○ zincata/zinc	x3

magix

4-legs/armrest option

main component sizes

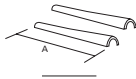

12



12 bracciolo destro e sinistro plastica conico left right black plastic conic arm

code	finishing	q.kit	q.pack	a	kg.x1	vol.x1
131703-041	● nero/black	x2	200	205	0,04	mc. 0.0002

4-legs/backrest and seat options

main component sizes

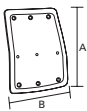

16



16 magix shi-schienale interno alto plastica nero magix shi-inside black plastic inner back

code	finishing	q.kit	q.pack	a	b	kg.x1	vol.x1
132103-043	● nero/black	x1	20	540	450	1,80	mc. 0.0055

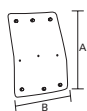

17

17 magix she-schienale alto esterno plastica nero magix she-black plastic external high back

code	finishing	q.kit	q.pack	a	b	kg.x1	vol.x1
132103-042	● nero/black	x1	20	540	450	0,50	mc. 0.0069

and · 10 14 15 13

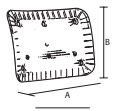

08



08 magix shi-schienale interno plastica nero magix shi-black plastic inner back

code	finishing	q.kit	q.pack	a	b	kg.x1	vol.x1
132103-040	● nero/black	x1	20	470	290	0,95	mc. 0.004

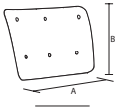

09

09 magix she-schienale esterno plastica nero magix she-black plastic external back

code	finishing	q.kit	q.pack	a	b	kg.x1	vol.x1
132103-041	● nero/black	x1	20	470	290	0,26	mc. 0.0055

and · 10 14 15 13

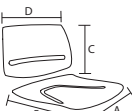

20



20 sedile e schienale a vista urban seat and back sight urban

code	finishing	q.kit	q.pack	a	b	c	d	kg.x1	vol.x1
134003-112	● nero/black	x1	10	452	425	288	453	2,5	mc. 0.016
134004-112	● grigio/grey	x1	10	452	425	288	453	2,5	mc. 0.016
134005-112	○ bianco/white	x1	10	452	425	288	453	2,5	mc. 0.016

and · 19 35 13

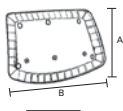

21



21 schienale interno urban inner back urban

code	finishing	q.kit	q.pack	a	b	kg.x1	vol.x1
132103-039	● nero/black	x1	20	450	540	0,77	mc. 0.006

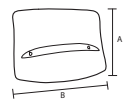

22

22 schienale esterno urban outer back urban

code	finishing	q.kit	q.pack	a	b	kg.x1	vol.x1
132103-038	● nero/black	x1	20	450	540	0,24	mc. 0.006

and · 10 14 15 13

magix

4-legs for castors

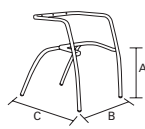
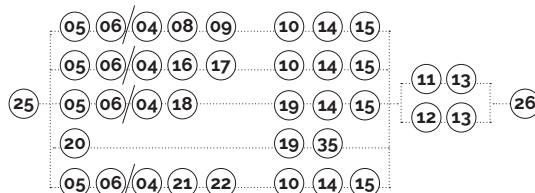
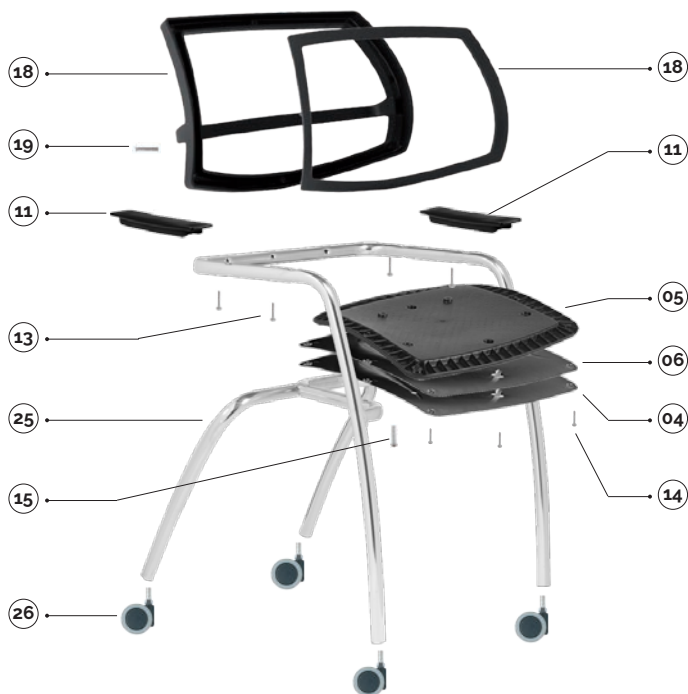

25

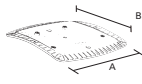

05



06

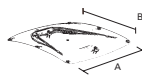

04

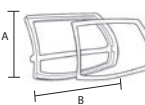

18

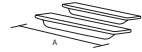

11

main component sizes

25 magix-telaio quattro gambe d.25 con riduttori per ruote magix-four legs frame d.25 with adapter for castor

code	finishing	q.kit	q.pack	a	b	c	kg.x1	vol.x1
110103-005	● nero/black	x1	30	450	550	550	3,90	mc. 0,045
110104-005	● grigio/grey	x1	30	450	550	550	3,90	mc. 0,045
110110-005	● cromato/chrome	x1	30	450	550	550	3,90	mc. 0,045

26 doppia ruota d.50 in desmopan con perno montato twin wheel castor d.50 desmopan with pivot mounted

code	finishing	q.kit
134403-003	● nero/black	x4

05 magix sdi-sedile interno plastica nero magix sdi-black plastic inner seat

code	finishing	q.kit	q.pack	a	b	kg.x1	vol.x1
132203-035	● nero/black	x1	10	480	460	1,10	mc. 0,045

06 magix sde-sedile esterno plastica nero magix sde-black plastic external seat

code	finishing	q.kit	q.pack	a	b	kg.x1	vol.x1
132203-036	● nero/black	x1	20	450	420	0,34	mc. 0,051

04 magix sde-sedile esterno plastica nero per telaio 4 gambe magix sde-black plastic external seat for 4-legs frame

code	finishing	q.kit	q.pack	a	b	kg.x1	vol.x1
132203-038	● nero/black	x1	20	450	420	0,452	mc. 0,051

18 schienale e cornice per rete urban outer back and open frame for urban net

code	finishing	q.kit	q.pack	a	b	kg.x1	vol.x1
132103-037	● nero/black	x1	10	288	453	0,98	mc. 0,015

11 bracciolo destro e sinistro plastica nero left right black plastic arm

code	finishing	q.kit	q.pack	a	kg.x1	vol.x1
131703-040	● nero/black	x2	100	200	0,04	mc. 0,0004

13 confezioni viti trucioliari tsp+ d.4x25 zincate (per fissare braccioli) shaving screws tsp+ d.4x25 zinc package (for arms)

code	finishing	q.kit	q.pack
117011-072	○ zincata/zinc	x4	200

14 confezione viti tbl+ fr. d.5x14 brunita nera screws tbl+ fr.hilo d.5x14 burnished black package

code	finishing	q.kit	q.pack
117003-071	● nero/black	x6	200

15 vite tsp+m6x35 zincata per il sedile screw tsp+m6x35 zinc for the seat

code	finishing	q.kit
117711-183	○ zincata/zinc	x4

19 vite tspcei m6x35 screw tspcei m6x35

code	finishing	q.kit
117711-180	○ zincata/zinc	x3

magix

4-legs for castors/armrest option

main component sizes

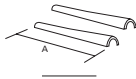

12



12 bracciolo destro e sinistro plastica conico left right black plastic conic arm

code	finishing	q.kit	q.pack	a	kg.x1	vol.x1
131703-041	● nero/black	x2	200	205	0,04	mc. 0.0002

4-legs for castors/backrest and seat options

main component sizes

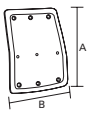

16



16 magix shi-schienale interno alto plastica nero magix shi-inside black plastic inner back

code	finishing	q.kit	q.pack	a	b	kg.x1	vol.x1
132103-043	● nero/black	x1	20	540	450	1,80	mc. 0.0055

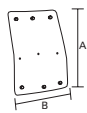

17

17 magix she-schienale alto esterno plastica nero magix she-black plastic external high back

code	finishing	q.kit	q.pack	a	b	kg.x1	vol.x1
132103-042	● nero/black	x1	20	540	450	0,50	mc. 0.0069

and · 10 14 15 13

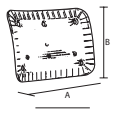

08



08 magix shi-schienale interno plastica nero magix shi-black plastic inner back

code	finishing	q.kit	q.pack	a	b	kg.x1	vol.x1
132103-040	● nero/black	x1	20	470	290	0,95	mc. 0.004

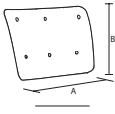

09

09 magix she-schienale esterno plastica nero magix she-black plastic external back

code	finishing	q.kit	q.pack	a	b	kg.x1	vol.x1
132103-041	● nero/black	x1	20	470	290	0,26	mc. 0.055

and · 10 14 15 13

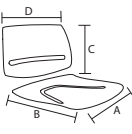

20



20 sedile e schienale a vista urban seat and back sight urban

code	finishing	q.kit	q.pack	a	b	c	d	kg.x1	vol.x1
134003-112	● nero/black	x1	10	452	425	288	453	2,5	mc. 0.016
134004-112	● grigio/grey	x1	10	452	425	288	453	2,5	mc. 0.016
134005-112	○ bianco/white	x1	10	452	425	288	453	2,5	mc. 0.016

and · 19 35 13

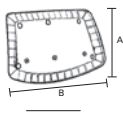

21



21 schienale interno urban inner back urban

code	finishing	q.kit	q.pack	a	b	kg.x1	vol.x1
132103-039	● nero/black	x1	20	450	540	0,77	mc. 0.006

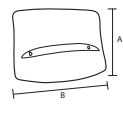

22

22 schienale esterno urban outer back urban

code	finishing	q.kit	q.pack	a	b	kg.x1	vol.x1
132103-038	● nero/black	x1	20	450	540	0,24	mc. 0.006

and · 10 14 15 13

magix

swivel

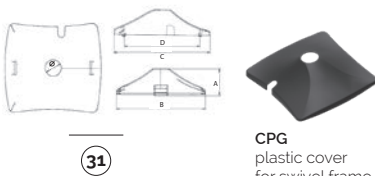
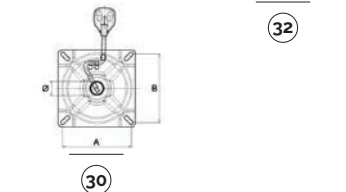
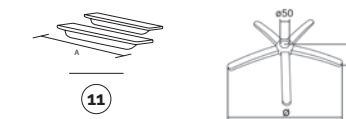
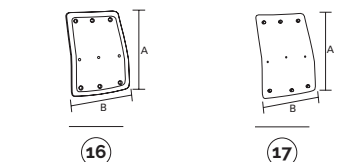
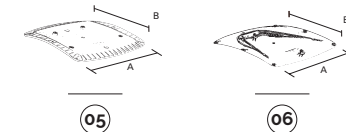
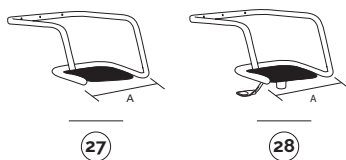
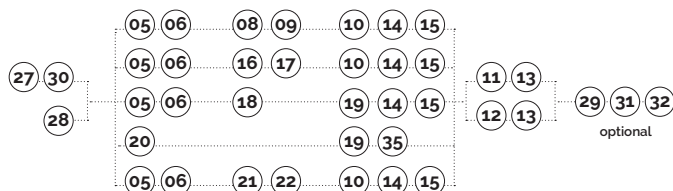

CPG
plastic cover
for swivel frame

main component sizes

optionals

27 magix-telaio girevole d.25 con braccioli senza tappi magix-d.25 swivelmetal frame arms without caps

code	finishing	q.kit	q.pack	a	kg.x1	vol.x1
110910-034	● cromato/chrome	x1	50	550	5,00	mc. 0.045

28 magix(01)gc-telaio girevole d.25 con braccioli senza tappi + spatola magix(01)gc-d.25 swivelmetal frame arms without caps with gas plate welded

code	finishing	q.kit	q.pack	a	kg.x1	vol.x1
110910-033	● cromato/chrome	x1	50	550	5,00	mc. 0.045

05 magix sdi-sedile interno plastica nero magix sdi-black plastic inner seat

code	finishing	q.kit	q.pack	a	b	kg.x1	vol.x1
132203-035	● nero/black	x1	10	480	460	1,10	mc. 0.045

06 magix sde-sedile esterno plastica nero magix sde-black plastic external seat

code	finishing	q.kit	q.pack	a	b	kg.x1	vol.x1
132203-036	● nero/black	x1	20	450	420	0,34	mc. 0.051

16 magix shi-schienale interno alto plastica nero magix shi-inside black plastic inner back

code	finishing	q.kit	q.pack	a	b	kg.x1	vol.x1
132103-043	● nero/black	x1	20	540	450	1,80	mc. 0.0055

17 magix she-schienale alto esterno plastica nero magix she-black plastic external high back

code	finishing	q.kit	q.pack	a	b	kg.x1	vol.x1
132103-042	● nero/black	x1	20	540	450	0,50	mc. 0.0069

10 vite tspcei m6x40 screw tspcei m6x40

code	finishing	q.kit
117711-250	○ zincata/zinc	x3

11 bracciolo destro e sinistro plastica nero left right black plastic arm

code	finishing	q.kit	q.pack	a	kg.x1	vol.x1
131703-040	● nero/black	x2	100	200	0,04	mc. 0.0004

13 confezioni viti trucciolari tsp+ d.4x25 zincate (per fissare braccioli) shaving screws tsp+ d.4x25 zinc package (for arms)

code	finishing	q.kit	q.pack
117011-072	○ zincata/zinc	x4	200

30 pss28nr-piastra sgabello c/spat. c/28 3' l4 nera pss28nr- square metal plate with straight lever c/28 3' l4

code	finishing	q.kit	q.pack	a	b	ø	kg.x1	vol.x1
113003-104	● nero/black	x1	25	150	150	28	1,23	mc. 0.002

31 cpq-copertina in plastica per telaio girevole cpq-plastic cover for swivel frame

code	finishing	q.kit	q.pack	a	b	c	d	ø	kg.x1	vol.x1
130903-000	● nero/black	x1	50	60	200	210	167	36	0,1	mc. 0.0015

32 b40 base in metallo d.640 con coprisaldatura b40 metal base d.640 with cover welding

code	finishing	q.kit	q.pack	a	ø	kg.x1	vol.x1
110210-027	● cromato/chrome	x1	5	60	640	2,85	mc. 0.014

14 confezione viti tbl+ fr. d.5x14 brunita nera screws tbl+ fr.hilo d.5x14 burnished black package

code	finishing	q.kit	q.pack
117003-071	● nero/black	x6	200

29 tappo copritesta alettato d.25 nero cover head d.25 black

code	finishing	q.kit
134103-250	● nero/black	x2

15 vite tsp+m6x35 zincata per il sedile screw tsp+m6x35 zinc for the seat

code	finishing	q.kit
117711-183	○ zincata/zinc	x4

magix

swivel/armrest option

main component sizes

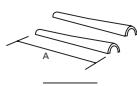

12



12 bracciolo destro e sinistro plastica conico
left right black plastic conic arm

code	finishing	q.kit	q.pack	a	kg.x1	vol.x1
131703-041	● nero/black	x2	200	205	0,04	mc. 0.0002

swivel/backrest and seat options

main component sizes

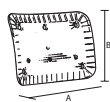

08



08 magix shi-schienale interno plastica nero
magix shi-black plastic inner back

code	finishing	q.kit	q.pack	a	b	kg.x1	vol.x1
132103-040	● nero/black	x1	20	470	290	0,95	mc. 0.004

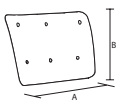

09

09 magix she-schienale esterno plastica nero
magix she-black plastic external back

code	finishing	q.kit	q.pack	a	b	kg.x1	vol.x1
132103-041	● nero/black	x1	20	470	290	0,26	mc. 0.055

and - **10** **14** **15** **13**



18



18 schienale e cornice per rete urban
outer back and open frame for urban net

code	finishing	q.kit	q.pack	a	b	kg.x1	vol.x1
132103-037	● nero/black	x1	10	288	453	0,98	mc. 0.015

19 vite tspcei m6x35
screw tspcei m6x35

code	finishing	q.kit
117711-180	○ zincata/zinc	x3

and - **14** **15** **13**

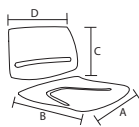

20



20 sedile e schienale a vista urban
seat and back sight urban

code	finishing	q.kit	q.pack	a	b	c	d	kg.x1	vol.x1
134003-112	● nero/black	x1	10	452	425	288	453	2,5	mc. 0.016
134004-112	● grigio/grey	x1	10	452	425	288	453	2,5	mc. 0.016
134005-112	○ bianco/white	x1	10	452	425	288	453	2,5	mc. 0.016

19 vite tspcei m6x35
screw tspcei m6x35

code	finishing	q.kit
117711-180	○ zincata/zinc	x3

and - **35** **13**

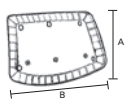

21



21 schienale interno urban
inner back urban

code	finishing	q.kit	q.pack	a	b	kg.x1	vol.x1
132103-039	● nero/black	x1	20	450	540	0,77	mc. 0.006

22 schienale esterno urban
outer back urban

code	finishing	q.kit	q.pack	a	b	kg.x1	vol.x1
132103-038	● nero/black	x1	20	450	540	0,24	mc. 0.006

and - **10** **14** **15** **13**

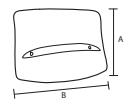

22

magix

bench

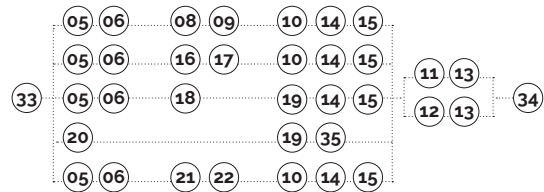

33 magix-telaio panca d.25 con braccioli senza tappi

magix-d.25 bench metal frame arms without caps

code	finishing	q.kit	q.pack	a	kg.x1	vol.x1
110710-200	● cromato/chrome	x1	60	550	5,00	mc. 0,045

20 sedile e schienale a vista urban

seat and back sight urban

code	finishing	q.kit	q.pack	a	b	c	d	kg.x1	vol.x1
134003-112	● nero/black	x1	10	452	425	288	453	2,5	mc. 0,016
134004-112	● grigio/grey	x1	10	452	425	288	453	2,5	mc. 0,016
134005-112	○ bianco/white	x1	10	452	425	288	453	2,5	mc. 0,016

19 vite tspcei m6x35

screw tspcei m6x35

code	finishing	q.kit
117711-180	○ zincata/zinc	x3

12 bracciolo destro e sinistro plastica conico

left right black plastic conic arm

code	finishing	q.kit	q.pack	a	kg.x1	vol.x1
131703-041	● nero/black	x2	200	205	0,04	mc. 0,0002

13 confezioni viti trucciolari tsp+ d.4x25 zincate (per fissare braccioli)

shaving screws tsp+ d.4x25 zinc package (for arms)

code	finishing	q.kit	q.pack
117011-072	○ zincata/zinc	x4	200

35 vite autoflettante ts+ 5,5x38 zincata

screw autofthreading ts+ 5,5x38 flared cross

code	finishing	q.kit
117811-165	○ zincata/zinc	x4

29 tappo copritesta alettato d.25 nero

cover head d.25 black

code	finishing	q.kit
134103-250	● nero/black	x2

34 got(03) trave per panca 80x40

got(03) beam for bench 80x40

code	finishing	posti	q.kit	q.pack	a	b	c	kg.x1	vol.x1
110703-190	● nero/black	2 posti/2 seats	x1	1	1160	80	40	3,20	mc. 0,0045
110704-190	● grigio/grey	2 posti/2 seats	x1	1	1160	80	40	3,20	mc. 0,0045
110703-191	● nero/black	3 posti/3 seats	x1	1	1710	80	40	4,71	mc. 0,005
110704-191	● grigio/grey	3 posti/3 seats	x1	1	1710	80	40	4,71	mc. 0,005
110703-192	● nero/black	4 posti/4 seats	x1	1	2260	80	40	6,22	mc. 0,0085
110704-192	● grigio/grey	4 posti/4 seats	x1	1	2260	80	40	6,22	mc. 0,0085
110703-193	● nero/black	5 posti/5 seats	x1	1	2800	80	40	7,72	mc. 0,01
110704-197	● grigio/grey	5 posti/5 seats	x1	1	2800	80	40	7,72	mc. 0,01

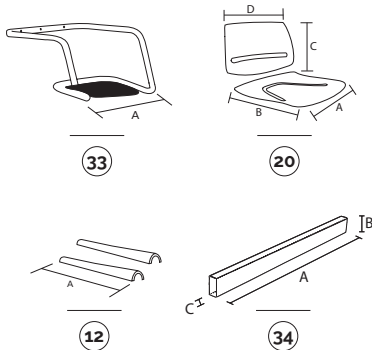

main component sizes

for the bench components, see page 249

OPTIONAL
bench
connector

E-USB **NEW**
bench plug

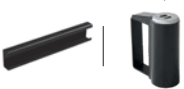

JIM **NEW**
bench leg

APOLL
bench arm



plastic

90GM
bench leg

90GF
bench leg

100GM
bench leg

200GM
bench leg

PIIONEER
bench arm



metal

CUT
bench leg

SLIM
bench leg

CUT
bench arm

SLIM
bench arm



aluminium

optionals

magix

bench/armrest option

main component sizes

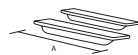

11



11 bracciolo destro e sinistro plastica nero left right black plastic arm

code	finishing	q.kit	q.pack	a	kg.x1	vol.x1
131703-040	● nero/black	x2	100	200	0,04	mc. 0.0004

bench/backrest and seat options

main component sizes

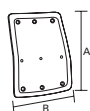

16



16 magix shi-schienale interno alto plastica nero magix shi-inside black plastic inner back

code	finishing	q.kit	q.pack	a	b	kg.x1	vol.x1
132103-043	● nero/black	x1	20	540	450	1,80	mc. 0.0055

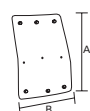

17



17 magix she-schienale alto esterno plastica nero magix she-black plastic external high back

code	finishing	q.kit	q.pack	a	b	kg.x1	vol.x1
132103-042	● nero/black	x1	20	540	450	0,50	mc. 0.0069

and · 10 14 15 13

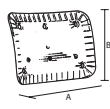

08



08 magix shi-schienale interno plastica nero magix shi-black plastic inner back

code	finishing	q.kit	q.pack	a	b	kg.x1	vol.x1
132103-040	● nero/black	x1	20	470	290	0,95	mc. 0.004

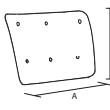

09



09 magix she-schienale esterno plastica nero magix she-black plastic external back

code	finishing	q.kit	q.pack	a	b	kg.x1	vol.x1
132103-041	● nero/black	x1	20	470	290	0,26	mc. 0.055

and · 10 14 15 13

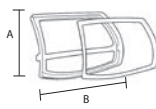

18



18 schienale e cornice per rete urban outer back and open frame for urban net

code	finishing	q.kit	q.pack	a	b	kg.x1	vol.x1
132103-037	● nero/black	x1	10	288	453	0,98	mc. 0.015

and · 19 14 15 13

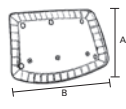

21



21 schienale interno urban inner back urban

code	finishing	q.kit	q.pack	a	b	kg.x1	vol.x1
132103-039	● nero/black	x1	20	450	540	0,77	mc. 0.006

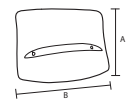

22



22 schienale esterno urban outer back urban

code	finishing	q.kit	q.pack	a	b	kg.x1	vol.x1
132103-038	● nero/black	x1	20	450	540	0,24	mc. 0.006

and · 10 14 15 13