



pinko



pinko



side

4 legs

4 legs with castors

swivel

folding bench
bench

pinko showing

features



trolley
available



L'ampia e confortevole seduta, unita all'elevato numero di opzioni e versioni di telai e componenti disponibili, la rendono ideale per qualsiasi utilizzo in **ambiente Office e Educational**.

Ma non solo, la **panca con sedile ribaltabile** completa un assortimento vario e completo, rendendo **Pinko** adatto anche all'**ambiente Community**.

*The large and comfortable seat, combined with the generous selection of options and versions of frames and components available make it ideal for use in any **Office and Educational environments**.*

*But its versatility doesn't end there: **the bench version with folding seat** rounds off a range which is both varied and complete, making **Pinko** suitable also for **Community environments**.*

pinko

4-legs

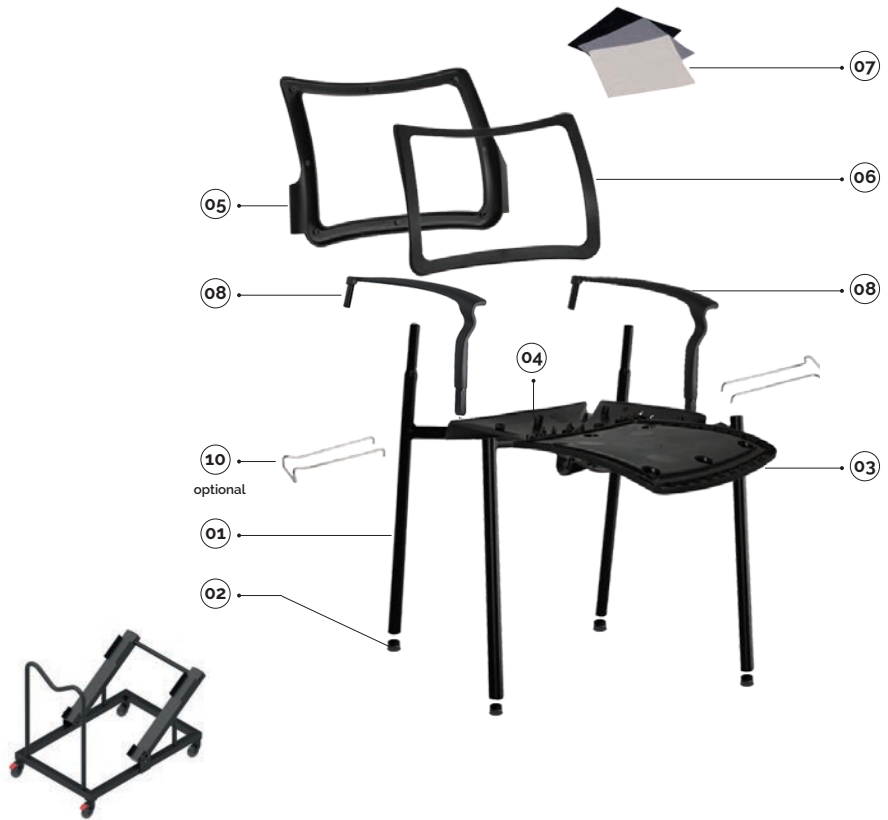

plastic colours

- blu/blue ral5002
- nero/black
- grigio/grey ral7035

pinko-carrello portasedie con accessori
pinko-trolley for chairs with accessories

code	finishing	q.kit
110803-340	● nero/black	x1

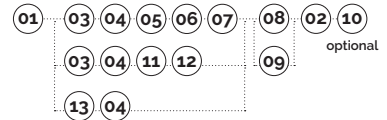

main component sizes

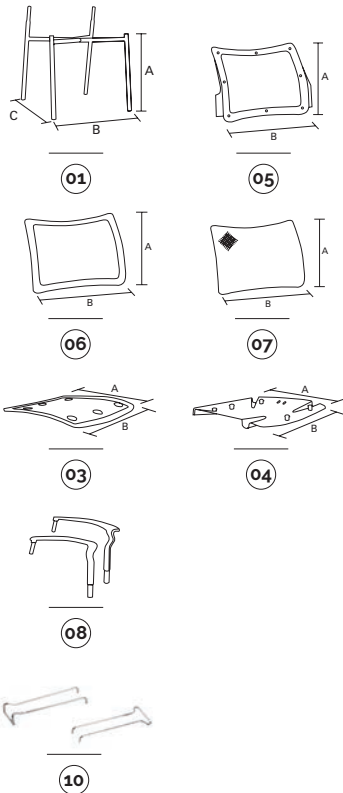

01 pinko-telaio quattro gambe fisso per braccioli senza tappi
pinko-fixed four legs frame for arms without caps

code	finishing	q.kit	q.pack	a	b	c	kg.x1	vol.x1
112603-040	● nero/black	x1	80	450	530	530	3,20	mc. 0.035
112604-040	● grigio/grey	x1	80	450	530	530	3,20	mc. 0.035
112610-040	● cromato/chrome	x1	80	450	530	530	3,20	mc. 0.035

02 confezione puntali a testa sferica d.25
cap d.25 spherical head black package

code	finishing	q.kit	q.pack
137003-075	● nero/black	x4	120

03 pinko-sedile interno da tappezzare
pinko-inner seat for upholstery

code	finishing	q.kit	q.pack	a	b	kg.x1	vol.x1
132203-025	● nero/black	x1	10	465	470	0,73	mc. 0.006

04 pinko-sedile esterno plastica
pinko-outer plastic seat

code	finishing	q.kit	q.pack	a	b	kg.x1	vol.x1
132203-026	● nero/black	x1	20	465	470	0,62	mc. 0.007

05 pinko-telaio schienale in plastica per rete (portante) + 2 tappi schienale + 2 tappi sedile
pinko-back frame in plastic for mesh + 2 back caps + 2 seat caps

code	finishing	q.kit	q.pack	a	b	kg.x1	vol.x1
132103-027	● nero/black	x2	20	345	495	0,50	mc. 0.0045

06 pinko-cornice schienale in plastica per rete
pinko-frame in plastic for mesh

code	finishing	q.kit	q.pack	a	b	kg.x1	vol.x1
132103-028	● nero/black	x1	10	345	495	0,35	mc. 0.0057

07 pinko-rete per schienale
pinko-net for pinko back

code	finishing	q.kit	q.pack	a	b	kg.x1	vol.x1
132105-501	○ bianco/white	x1	25	460	520	0,14	mc. 0.0057
132103-501	● nero/black	x1	25	460	520	0,14	mc. 0.0057
132104-501	● grigio/grey	x1	25	460	520	0,14	mc. 0.0057

08 pinko-coppia braccioli dx/sx in plastica
pinko-pair of plastic arms right/left

code	finishing	q.kit	q.pack	kg.x1	vol.x1
131703-050	● nero/black	x1	10	0,66	mc. 0.0037

10 pinko/logan-coppia agganci laterale maschio + femmina cromati
pinko/logan-chrome lateral hooks male + femal with screws

code	finishing	q.kit	q.pack	kg.x1	vol.x1
113410-100	● cromato/chrome	x1	100	0,13	mc. 0.0004

optionals

pinko

4-legs/tablet accessories

main component sizes



09



09 pinko-coppia braccioli + gancio portavoletta destro in plastica pinko-pair of plastic arms right/left with joint for writing tablet

code	finishing	q.kit	q.pack	kg.x1	vol.x1
131703-051	● nero/black	x1	10	0,70	mc. 0,0037

TLT
tablet



TLT2
tablet



TLT3
tablet



BEAN
tablet



TL02
tablet



SPT2
mechanism tablet



SPTA
mechanism antipanic



for writing tablet options, see page 192/193

4-legs/seat and backrest options

main component sizes

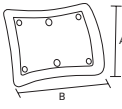

11



11 pinko-schienale interno da tappezzare pinko-inner back for upholstery

code	finishing	q.kit	q.pack	a	b	kg.x1	vol.x1
132103-025	● nero/black	x1	20	350	495	0,62	mc. 0,009

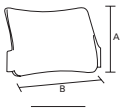

12

12 pinko-schienale esterno plastica + 2 tappi schienale + 2 tappi sedile pinko-outer plastic back + 2 back caps + 2 seat caps

code	finishing	q.kit	q.pack	a	b	kg.x1	vol.x1
132103-026	● nero/black	x1	10	350	495	0,25	mc. 0,0045

and 03 04

main component sizes

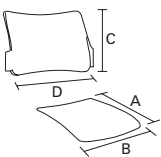

13



13 pinko-sedile/schienale in plastica colorato a vista + 2 tappi schienale + 2 tappi sedile pinko-plastic seat/back coloured at sight + 2 back caps + 2 seat caps

code	finishing	q.kit	q.pack	a	b	c	d	kg.x1	vol.x1	
134015-108	● blu/blue	ral 5002	x1	10	470	465	350	495	1,78	mc. 0,014
134003-108	● nero/black		x1	10	470	465	350	495	1,78	mc. 0,014
134004-109	● grigio/grey	ral 7035	x1	10	470	465	350	495	1,78	mc. 0,014

and 04

pinko

4-legs for castors



plastic colours

- blu/blue ral5002
- nero/black
- grigio/grey ral7035

main component sizes

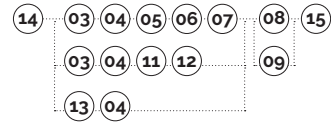
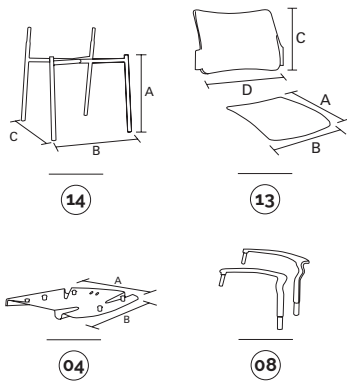

14 pinko-telaio quattro gambe per ruote + 4 riduttori per ruote pinko four legs frame for castors + 4 adapters for castors

code	finishing	q.kit	q.pack	a	b	c	kg.x1	vol.x1
112603-041	● nero/black	x1	80	390	530	530	3,20	mc. 0.035
112604-041	● grigio/grey	x1	80	390	530	530	3,20	mc. 0.035
112610-041	● cromato/chrome	x1	80	390	530	530	3,20	mc. 0.035

15 doppia ruota d.50 in desmopan con perno montato twin wheel castor d.50 desmopan with pivot mounted

code	finishing	q.kit
134403-003	● nero/black	x4

13 pinko-sedile/schienale in plastica colorato a vista + 2 tappi schienale + 2 tappi sedile pinko-plastic seat/back coloured at sight + 2 back caps + 2 seat caps

code	finishing	q.kit	q.pack	a	b	c	d	kg.x1	vol.x1
134015-108	● blu/blue ral 5002	x1	10	470	465	350	495	1,78	mc. 0.014
134003-108	● nero/black	x1	10	470	465	350	495	1,78	mc. 0.014
134004-109	● grigio/grey ral 7035	x1	10	470	465	350	495	1,78	mc. 0.014

04 pinko-sedile esterno plastica pinko-outer plastic seat

code	finishing	q.kit	q.pack	a	b	kg.x1	vol.x1
132203-026	● nero/black	x1	20	465	470	0,62	mc. 0.007

08 pinko-coppia braccioli dx/sx in plastica pinko-pair of plastic arms right/left

code	finishing	q.kit	q.pack	kg.x1	vol.x1
131703-050	● nero/black	x1	10	0,66	mc. 0.0037

pinko-carrello portasedie con accessori nero pinko-trolley for chairs with accessories black

code	finishing	q.kit
110803-340	● nero/black	x1



pinko

4-legs for castors/tablet accessories

main component sizes



09



09 pinko-coppia braccioli + gancio portavoletta destro in plastica
pinko-pair of plastic arms right/left with joint for writing tablet

code	finishing	q.kit	q.pack	kg.x1	vol.x1
131703-051	● nero/black	x1	10	0,70	mc. 0,0037

TLT
tablet

TLT2
tablet

TLT3
tablet

BEAN
tablet

TL02
tablet

SPT2
mechanism tablet

SPTA
mechanism antipanic



for writing tablet options, see page 192/193

4-legs/seat and backrest options

main component sizes

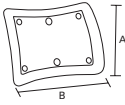

11

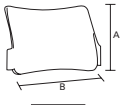

12



11 pinko-schienale interno da tappezzare
pinko-inner back for upholstery

code	finishing	q.kit	q.pack	a	b	kg.x1	vol.x1
132103-025	● nero/black	x1	20	350	495	0,62	mc. 0,009

12 pinko-schienale esterno plastica + 2 tappi schienale + 2 tappi sedile
pinko-outer plastic back + 2 back caps + 2 seat caps

code	finishing	q.kit	q.pack	a	b	kg.x1	vol.x1
132103-026	● nero/black	x1	10	350	495	0,25	mc. 0,0045

and **03** **04**

main component sizes

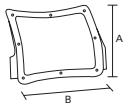

05

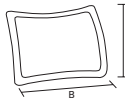

06

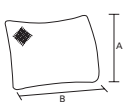

07



05 pinko-telaio schienale in plastica per rete (portante) + 2 tappi schienale + 2 tappi sedile
pinko-back frame in plastic for mesh + 2 back caps + 2 seat caps

code	finishing	q.kit	q.pack	a	b	kg.x1	vol.x1
132103-027	● nero/black	x2	20	345	495	0,50	mc. 0,0045

06 pinko-cornice schienale in plastica per rete
pinko-open frame in plastic for mesh

code	finishing	q.kit	q.pack	a	b	kg.x1	vol.x1
132103-028	● nero/black	x1	10	345	495	0,35	mc. 0,0057

07 pinko-rete per schienale
pinko-net for pinko back

code	finishing	q.kit	q.pack	a	b	kg.x1	vol.x1
132105-501	○ bianco/white	x1	25	460	520	0,14	mc. 0,0057
132103-501	● nero/black	x1	25	460	520	0,14	mc. 0,0057
132104-501	● grigio/grey	x1	25	460	520	0,14	mc. 0,0057

and **03** **04**

pinko

slide



plastic colours

- blu/blue ral5002
- nero/black
- grigio/grey ral7035

main component sizes

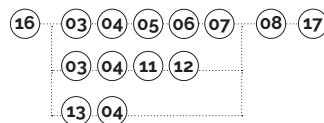
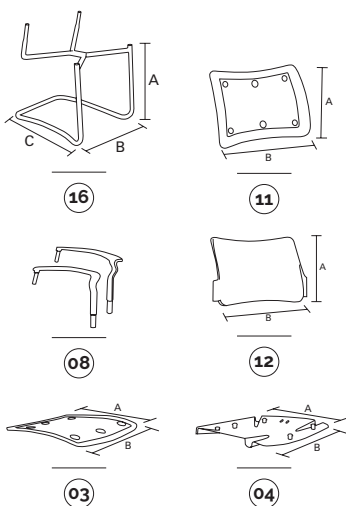

16 pinko-base a slitta in tubo asform d.25 tappi esclusi
pinko-slide frame pipe d.25 without caps

code	finishing	q.kit	q.pack	a	b	c	kg.x1	vol.x1
110503-093	● nero/black	x1	40	450	550	550	4,60	mc. 0,06
110504-093	● grigio/grey	x1	40	450	550	550	4,60	mc. 0,06
110510-093	● cromato/chrome	x1	40	450	550	550	4,60	mc. 0,06

17 paracolpi testa bombata d.18
round head cap d.18

code	finishing	q.kit
134403-101	● nero/black	x4

03 pinko-sedile interno da tappezzare
pinko-inner seat for upholstery

code	finishing	q.kit	q.pack	a	b	kg.x1	vol.x1
132203-025	● nero/black	x1	10	465	470	0,73	mc. 0,006

04 pinko-sedile esterno plastica
pinko-outer plastic seat

code	finishing	q.kit	q.pack	a	b	kg.x1	vol.x1
132203-026	● nero/black	x1	20	465	470	0,62	mc. 0,007

11 pinko-schienale interno da tappezzare
pinko-inner back for upholstery

code	finishing	q.kit	q.pack	a	b	kg.x1	vol.x1
132103-025	● nero/black	x1	20	350	495	0,62	mc. 0,009

12 pinko-schienale esterno plastica + 2 tappi schienale + 2 tappi sedile
pinko-outer plastic back + 2 back caps + 2 seat caps

code	finishing	q.kit	q.pack	a	b	kg.x1	vol.x1
132103-026	● nero/black	x1	10	350	495	0,25	mc. 0,0045

08 pinko-coppia braccioli dx/sx in plastica
pinko-pair of plastic arms right/left

code	finishing	q.kit	q.pack	kg.x1	vol.x1
131703-050	● nero/black	x1	10	0,66	mc. 0,0037

pinko

slide/seat and backrest options

main component sizes

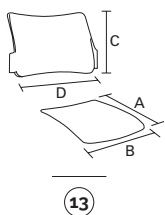

13 pinko-sedile/schienale in plastica colorato a vista + 2 tappi schienale + 2 tappi sedile
pinko-plastic seat/back coloured at sight + 2 back caps + 2 seat caps

code	finishing		q.kit	q.pack	a	b	c	d	kg.x1	vol.x1
134015-108	● blu/blue	ral 5002	x1	10	470	465	350	495	1,78	mc. 0.014
134003-108	● nero/black		x1	10	470	465	350	495	1,78	mc. 0.014
134004-109	● grigio/grey	ral 7035	x1	10	470	465	350	495	1,78	mc. 0.014

and **04**

main component sizes

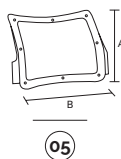

05 pinko-telaio schienale in plastica per rete (portante) + 2 tappi schienale + 2 tappi sedile
pinko-back frame in plastic for mesh + 2 back caps + 2 seat caps

code	finishing	q.kit	q.pack	a	b	kg.x1	vol.x1
132103-027	● nero/black	x2	20	345	495	0,50	mc. 0.0045

06 pinko-cornice schienale in plastica per rete
pinko-open frame in plastic for mesh

code	finishing	q.kit	q.pack	a	b	kg.x1	vol.x1
132103-028	● nero/black	x1	10	345	495	0,35	mc. 0.0057

07 pinko-rete per schienale
pinko-net for pinko back

code	finishing	q.kit	q.pack	a	b	kg.x1	vol.x1
132105-501	○ bianco/white	x1	25	460	520	0,14	mc. 0.0057
132103-501	● nero/black	x1	25	460	520	0,14	mc. 0.0057
132104-501	● grigio/grey	x1	25	460	520	0,14	mc. 0.0057

and **03** **04**

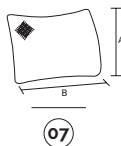
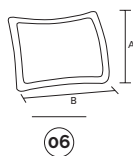

pinko

swivel



plastic colours

- blu/blue ral5002
- nero/black
- grigio/grey ral7035

main component sizes

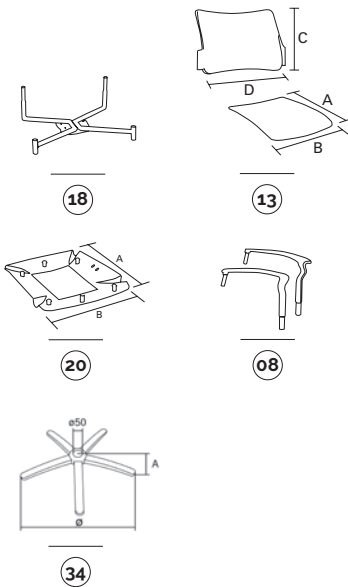

optionals

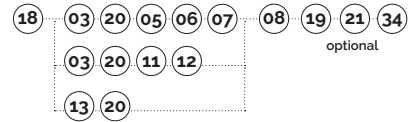
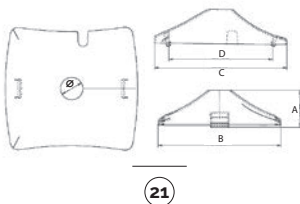

18 pinko-telaio per girevole comando a gas senza tappi pinko-swivel frame with gas lever without caps

code	finishing	q.kit	q.pack	kg.x1	vol.x1
112603-045	● nero/black	x1	80	2,60	mc. 0,005
112604-045	● grigio/grey	x1	80	2,60	mc. 0,005

19 tappo copritesta alettato d.25 nero cover head d.25 black

code	finishing	q.kit
134103-250	● nero/black	x2

13 pinko-sedile/schienale in plastica colorato a vista + 2 tappi schienale + 2 tappi sedile pinko-plastic seat/back coloured at sight + 2 back caps + 2 seat caps

code	finishing	q.kit	q.pack	a	b	c	d	kg.x1	vol.x1
134015-108	● blu/blue ral 5002	x1	10	470	465	350	495	1,78	mc. 0,014
134003-108	● nero/black	x1	10	470	465	350	495	1,78	mc. 0,014
134004-109	● grigio/grey ral 7035	x1	10	470	465	350	495	1,78	mc. 0,014

20 pinko-sedile esterno plastica per girevole e panca pinko-plastic outer seat for swivel and bench

code	finishing	q.kit	q.pack	a	b	kg.x1	vol.x1
132203-027	● nero/black	x1	20	465	470	0,60	mc. 0,007

08 pinko-coppia braccioli dx/sx in plastica pinko-pair of plastic arms right/left

code	finishing	q.kit	q.pack	kg.x1	vol.x1
131703-050	● nero/black	x1	10	0,66	mc. 0,0037

21 cpg-copertina in plastica per telaio girevole cpg-plastic cover for swivel frame

code	finishing	q.kit	q.pack	a	b	c	d	ø	kg.x1	vol.x1
130903-000	● nero/black	x1	50	60	200	210	167	36	0,1	mc. 0,0015

34 b40 base in metallo d.640 con coprisaldatura b40 metal base d.640 with cover welding

code	finishing	q.kit	q.pack	a	ø	kg.x1	vol.x1
110210-027	● cromato/chrome	x1	5	60	640	2,85	mc. 0,014

CPG
plastic cover for swivel frame



pinko

swivel/seat and backrest options

main component sizes

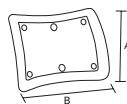

11

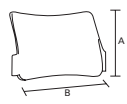

12



11 pinko-schienale interno da tappezzare
pinko-inner back for upholstery

code	finishing	q.kit	q.pack	a	b	kg.x1	vol.x1
132103-025	● nero/black	x1	20	350	495	0,62	mc. 0.009

12 pinko-schienale esterno plastica + 2 tappi schienale + 2 tappi sedile
pinko-outer plastic back + 2 back caps + 2 seat caps

code	finishing	q.kit	q.pack	a	b	kg.x1	vol.x1
132103-026	● nero/black	x1	10	350	495	0,25	mc. 0.0045

and **03** **20**

main component sizes

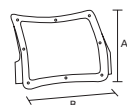

05

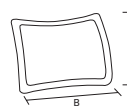

06

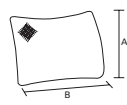

07



05 pinko-telaio schienale in plastica per rete (portante) + 2 tappi schienale + 2 tappi sedile
pinko-back frame in plastic for mesh + 2 back caps + 2 seat caps

code	finishing	q.kit	q.pack	a	b	kg.x1	vol.x1
132103-027	● nero/black	x2	20	345	495	0,50	mc. 0.0045

06 pinko-cornice schienale in plastica per rete
pinko-open frame in plastic for mesh

code	finishing	q.kit	q.pack	a	b	kg.x1	vol.x1
132103-028	● nero/black	x1	10	345	495	0,35	mc. 0.0057

07 pinko-rete per schienale
pinko-net for pinko back

code	finishing	q.kit	q.pack	a	b	kg.x1	vol.x1
132105-501	○ bianco/white	x1	25	460	520	0,14	mc. 0.0057
132103-501	● nero/black	x1	25	460	520	0,14	mc. 0.0057
132104-501	● grigio/grey	x1	25	460	520	0,14	mc. 0.0057

and **03** **20**

pinko

bench



plastic colours

- blu/blue ral5002
- nero/black
- grigio/grey ral7035

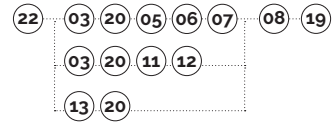

main component sizes

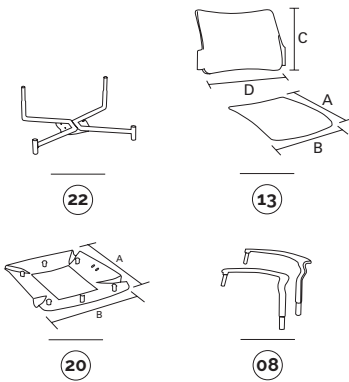

22 pinko-telaio per panca senza tappi pinko-bench frame caps excluded

code	finishing	q.kit	q.pack	kg.x1	vol.x1
110703-072	● nero/black	x1	80	2,50	mc. 0.005
110704-072	● grigio/grey	x1	80	2,50	mc. 0.005

19 tappo copritesta alettato d.25 nero cover head d.25 black

code	finishing	q.kit
134103-250	● nero/black	x2

13 pinko-sedile/schienale in plastica colorato a vista + 2 tappi schienale + 2 tappi sedile pinko-plastic seat/back coloured at sight + 2 back caps + 2 seat caps

code	finishing	q.kit	q.pack	a	b	c	d	kg.x1	vol.x1
134015-108	● blu/blue ral 5002	x1	10	470	465	350	495	1,78	mc. 0.014
134003-108	● nero/black	x1	10	470	465	350	495	1,78	mc. 0.014
134004-109	● grigio/grey ral 7035	x1	10	470	465	350	495	1,78	mc. 0.014

20 pinko-sedile esterno plastica per girevole e panca pinko-plastic outer seat for swivel and bench

code	finishing	q.kit	q.pack	a	b	kg.x1	vol.x1
132203-027	● nero/black	x1	20	465	470	0,60	mc. 0.007

08 pinko-coppia braccioli dx/sx in plastica pinko-pair of plastic arms right/left

code	finishing	q.kit	q.pack	kg.x1	vol.x1
131703-050	● nero/black	x1	10	0,66	mc. 0.0037

for the bench components, see page 201

optionals

OPTIONAL
bench
connector



E-USB **NEW**
bench plug



JIM **NEW**
bench leg



APOLL
bench arm



plastic

90GM
bench leg



90GF
bench leg



100GM
bench leg



200GM
bench leg



PIONEER
bench arm



metal

CUT
bench leg



SLIM
bench leg



CUT
bench arm



SLIM
bench arm



aluminium

pinko

bench/seat and backrest options

main component sizes

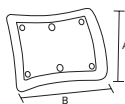

11

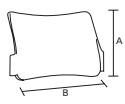

12



11 pinko-schienale interno da tappezzare
pinko-inner back for upholstery

code	finishing	q.kit	q.pack	a	b	kg.x1	vol.x1
132103-025	● nero/black	x1	20	350	495	0,62	mc. 0.009

12 pinko-schienale esterno plastica + 2 tappi schienale + 2 tappi sedile
pinko-outer plastic back + 2 back caps + 2 seat caps

code	finishing	q.kit	q.pack	a	b	kg.x1	vol.x1
132103-026	● nero/black	x1	10	350	495	0,25	mc. 0.0045

and **03** **20**

main component sizes

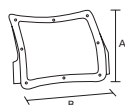

05

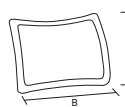

06

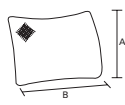

07



05 pinko-telaio schienale in plastica per rete (portante) + 2 tappi schienale + 2 tappi sedile
pinko-back frame in plastic for mesh + 2 back caps + 2 seat caps

code	finishing	q.kit	q.pack	a	b	kg.x1	vol.x1
132103-027	● nero/black	x2	20	345	495	0,50	mc. 0.0045

06 pinko-cornice schienale in plastica per rete
pinko-open frame in plastic for mesh

code	finishing	q.kit	q.pack	a	b	kg.x1	vol.x1
132103-028	● nero/black	x1	10	345	495	0,35	mc. 0.0057

07 pinko-rete per schienale
pinko-net for pinko back

code	finishing	q.kit	q.pack	a	b	kg.x1	vol.x1
132105-501	○ bianco/white	x1	25	460	520	0,14	mc. 0.0057
132103-501	● nero/black	x1	25	460	520	0,14	mc. 0.0057
132104-501	● grigio/grey	x1	25	460	520	0,14	mc. 0.0057

and **03** **20**

pinko

folding bench

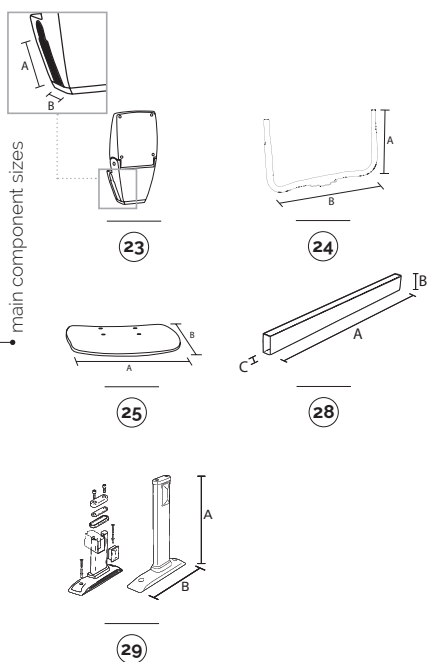
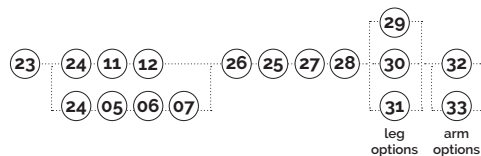

main component sizes

23 siton-meccanismo panca ribaltabile alluminio lucido siton-polished aluminium mechanism for folding bench

code	finishing	q.kit	q.pack	a	b	kg.x1	vol.x1
110704-180	● alluminio/aluminium	x1	4	80	40	2,81	mc. 0,007

24 pinko-telaio schienale a U per panca ribaltabile pinko-frame back bench for folding

code	finishing	q.kit	q.pack	a	b	kg.x1	vol.x1
110703-071	● nero/black	x1	15	300	490	1,40	mc. 0,003
110704-182	● grigio/grey	x1	15	300	490	1,40	mc. 0,003

25 siton-sedile panca ribaltabile in legno per tappezzeria siton-bench seat folding wooden for upholstery

code	finishing	q.kit	q.pack	a	b	kg.x1	vol.x1
122207-003	● grezzo/raw	x1	10	420	410	1,30	mc. 0,007

26 vite tcei m5x16 brunita nera (vite per fissaggio telaio schienale in tubo) screw m5x16 cylindrical head hexagon embedded burnishing black (screw for tube back frame fixing)

code	finishing	q.kit
117703-160	● nero/black	x4

27 vite tcei m6x20 zincata (vite per fissaggio sedile) screw m6x20 cylindrical head hexagon embedded burnishing zinc (screw for seat fixing)

code	finishing	q.kit
117711-198	● zincata/zinc	x4

28 90T(03) trave per panca 80x40 90T(03) beam for bench 80x40

code	finishing		q.kit	q.pack	a	b	c	kg.x1	vol.x1
110703-190	● nero/black	2 posti / 2 seats	x1	1	1160	80	40	3,20	mc. 0,0045
110704-190	● grigio/grey	2 posti / 2 seats	x1	1	1160	80	40	3,20	mc. 0,0045
110703-191	● nero/black	3 posti / 3 seats	x1	1	1710	80	40	4,71	mc. 0,005
110704-191	● grigio/grey	3 posti / 3 seats	x1	1	1710	80	40	4,71	mc. 0,005
110703-192	● nero/black	4 posti / 4 seats	x1	1	2260	80	40	6,22	mc. 0,0085
110704-192	● grigio/grey	4 posti / 4 seats	x1	1	2260	80	40	6,22	mc. 0,0085
110703-193	● nero/black	5 posti / 5 seats	x1	1	2800	80	40	7,72	mc. 0,001
110704-193	● grigio/grey	5 posti / 5 seats	x1	1	2800	80	40	7,72	mc. 0,001

29 90GF(02)-gamba fissa per panca con accessori 90GF(02)-fixed leg for bench with accessories

code	finishing	q.kit	q.pack	a	b	kg.x1	vol.x1
110703-122	● nero/black	x2	2	320	310	1,80	mc. 0,0012
110704-107	● grigio/grey	x2	2	320	310	1,80	mc. 0,0012

for the components below, see page 43

for the bench components, see page 201

pinko

folding bench/tablet accessories



folding bench/seat and backrest option

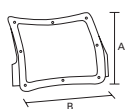

05

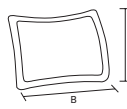

06

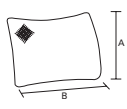

07



- 05 pinko-telaio schienale in plastica per rete (portante) + 2 tappi schienale + 2 tappi sedile
pinko-back frame in plastic for mesh + 2 back caps + 2 seat caps

code	finishing	q.kit	q.pack	a	b	kg.x1	vol.x1
132103-027	● nero/black	x2	20	345	495	0,50	mc. 0.0045

- 06 pinko-cornice schienale in plastica per rete
pinko-open frame in plastic for mesh

code	finishing	q.kit	q.pack	a	b	kg.x1	vol.x1
132103-028	● nero/black	x1	10	345	495	0,35	mc. 0.0057

- 07 pinko-rete per schienale
pinko-net for pinko back

code	finishing	q.kit	q.pack	a	b	kg.x1	vol.x1
132105-501	○ bianco/white	x1	25	460	520	0,14	mc. 0.0057
132103-501	● nero/black	x1	25	460	520	0,14	mc. 0.0057
132104-501	● grigio/grey	x1	25	460	520	0,14	mc. 0.0057

and 24 26 25 27

folding bench/leg and armrest options

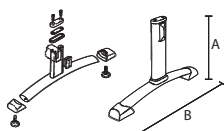

05



- 30 90gm(02)-gamba mobile per panca con accessori
90gm(02)-movable leg for bench with accessories

code	finishing	q.kit	q.pack	a	b	kg.x1	vol.x1
110703-120	● nero/black	x2	2	320	600	2,70	mc. 0.0012
110704-099	● grigio/grey	x2	2	320	600	2,70	mc. 0.0012
110710-007	● cromato/chrome	x2	2	320	600	2,70	mc. 0.0012

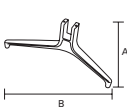

05



- 31 siton(ga02)-gamba lunga in alluminio per panca
siton(ga02)-long leg aluminium for bench

code	finishing	q.kit	q.pack	a	b	kg.x1	vol.x1
110704-171	● alluminio/aluminium	x2	5	305	643	2,80	mc. 0.014

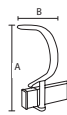

05



- 32 siton-bracciolo ellittico per panca con accessori
siton-elliptical arm for bench with accessories

code	finishing	q.kit	q.pack	a	b	kg.x1	vol.x1
111710-020	● cromato/chrome	x1	5	370	340	1,70	mc. 0.015
111703-019	● nero/black	x1	5	370	340	1,70	mc. 0.015

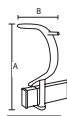

05



- 33 siton.p-bracciolo ellittico per panca con gancio porta tavoletta con accessori
siton.p-elliptical arm for bench with table hook with accessories

code	finishing	q.kit	q.pack	a	b	kg.x1	vol.x1
111710-017	● cromato/chrome	x1	5	370	340	1,70	mc. 0.015
111703-017	● nero/black	x1	5	370	340	1,70	mc. 0.015