



manila



discover more about
Manila Collection

La monoscocca in plastica con braccioli integrati. Una seduta ampia, confortevole e resistente, dal design sottile e distintivo, con braccioli disegnati per abbracciarla. Estremamente versatile grazie al ricco assortimento di telai, opzionabili anche in diverse finiture.

Manila è nata per arredare qualsiasi ambiente Community e ben si adatta agli ambienti Office.

Plastic monocoque chair with integrated armrests. A generous, comfortable and durable seat, featuring a subtle-yet-distinctive design, with armrests designed to embrace. Extremely versatile thanks to the rich assortment of frames. Available in a range of finishes.

Manila was created to furnish any Community environment and adapts perfectly also to Office environments.

Plus

- Dimensioni generose e massimo comfort della scocca.
- Design distintivo grazie ai braccioli integrati e alla scocca unica.
- 6 colori di tendenza disponibili per la scocca.
- Massima versatilità.
- Opzionabile il pannello in legno da tappezzare.
- *Generously-dimensioned seat shell providing maximum comfort.*
- *Distinctive design thanks to the integrated armrests and the unique seat shell.*
- *6 trendy colours available for the seat shell.*
- *Maximum versatility.*
- *Optional wooden seat pad to be upholstered.*

manila

slide



plastic colours

- rosso/red p1797u
- grigio/grey warm grey 6c
- avorio/ivory ral1013
- marrone/brown ral69g
- giallo/yellow ral110u
- blu/blue ral5014

main component sizes

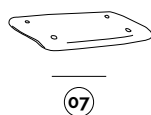
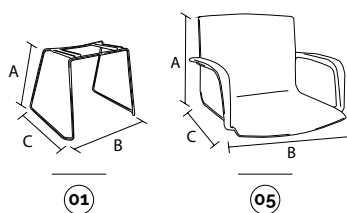

optionals

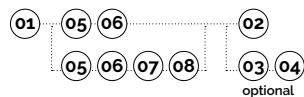
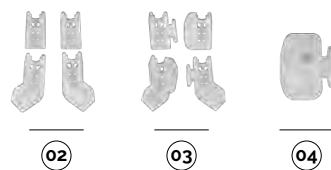

01 manila-telaio a slitta in tondino d.12
manila-slide wire framed.12

code	finishing	q.kit	q.pack	a	b	c	kg.x1	vol.x1
113403-333	● nero/black	x1	100	445	580	495	4,00	mc. 0,026
113405-333	○ avorio/ivory ral1013	x1	100	445	580	495	4,00	mc. 0,026
113410-333	● cromato/chrome	x1	100	445	580	495	4,00	mc. 0,026

02 btf-kit piedini
btf-kit feet

code	finishing	q.kit	q.pack	kg.x1
134306-001	○ neutro/neutral	x1	100	0,05

03 btfa-kit piedini con ganci
btfa-kit feet with hooks

code	finishing	q.kit	q.pack	kg.x1
134306-002	○ neutro/neutral	x1	100	0,06

04 pptf-tappo per fissaggio pavimento
pptf-cap for fixing to the floor

code	finishing	q.kit	q.pack	kg.x1
134306-003	○ neutro/neutral	x2	100	0,03

05 manila-scocca intera con braccioli
manila-plastic shell with arms

code	finishing	q.kit	q.pack	a	b	c	kg.x1	vol.x1
133904-045	● grigio/grey warm grey 6c	x1	5	390	580	480	2,60	mc. 0,05

06 manila-vite tc-combi 6x16 testa cilindrica a croce zincata (vite per fissaggio scocca)
manila-screw combi 6x16 cylindrical head cross zinc (screw for fix shell)

code	finishing	q.kit
117811-181	● zincata/zinc	x4

07 manila-pannello sedile multistrato con 6 borchie m6
manila-seat panel with 6 upholstery nail m6

code	finishing	q.kit	q.pack	kg.x1	vol.x1
122207-034	● faggio/plywood	x1	20	0,78	mc. 0,003

08 manila-vite tbl combi m6x12 zincata bianca (vite per fissaggio pannello)
manila-screw tbl combi m6x12 white zinc (screw for fix panel)

code	finishing	q.kit
117711-206	○ zincata bianca/white zinc	x6



manila

slide



plastic colours

- rosso/red p1797u
- grigio/grey warm grey 6c
- avorio/ivory ral1013
- marrone/brown ral699
- giallo/yellow ral110u
- blu/blue ral5014

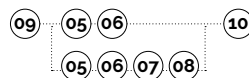

main component sizes

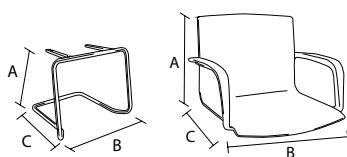

09 manila-base a slitta in tubo asform d.22 tappi esclusi

manila-slide frame asform pipe d.22 without caps

code	finishing	q.kit	q.pack	a	b	c	kg.x1	vol.x1
110503-417	● nero/black	x1	64	450	545	545	4.10	mc. 0.0313
110504-417	● grigio/grey ig2621	x1	64	450	545	545	4.10	mc. 0.0313
110505-417	○ avorio/ivory ral1013	x1	64	450	545	545	4.10	mc. 0.0313
110510-417	● cromato/chrome	x1	64	450	545	545	4.10	mc. 0.0313

10 p2p-pinza due pioli in polietilene nera

p2p-two pins pliers in black polythene

code	finishing	q.kit
134003-003	● nero/black	x6

05 manila-scocca intera con braccioli

manila-plastic shell with arms

code	finishing	q.kit	q.pack	a	b	c	kg.x1	vol.x1
133904-045	● grigio/grey warm grey 6c	x1	5	390	580	480	2.60	mc. 0.05

06 manila-vite tc-combi 6x16 testa cilindrica a croce zincata (vite per fissaggio scocca)

manila-screw combi 6x16 cylindrical head cross zinc (screw for fix shell)

code	finishing	q.kit
117811-181	● zincata/zinc	x4

07 manila-pannello sedile multistrato con 6 borchie m6

manila-seat panel with 6 upholstery nail m6

code	finishing	q.kit	q.pack	kg.x1	vol.x1
122207-034	● faggio/plywood	x1	20	0.78	mc. 0.003

08 manila-vite tbl combi m6x12 zincata bianca (vite per fissaggio pannello)

manila-screw tbl combi m6x12 white zinc (screw for fix panel)

code	finishing	q.kit
117711-206	○ zincata bianca/white zinc	x6



for all colour codes, see page 297

manila

4-legs



plastic colours

- rosso/red p1797u
- grigio/grey warm grey 6c
- avorio/ivory ral1013
- marrone/brown ral699
- giallo/yellow ral110u
- blu/blue ral5014

main component sizes

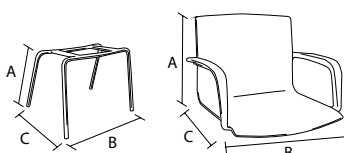

11

05

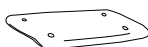

07

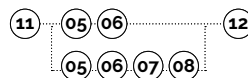

11 manila-telaio 4 gambe d.22 senza tappi
manila-4 legs frames d.22 without caps

code	finishing	q.kit	q.pack	a	b	c	kg.x1	vol.x1
110103-259	● nero/black	x1	80	440	585	490	2,70	mc. 0.035
110104-259	● grigio/grey ig2621	x1	80	440	585	490	2,70	mc. 0.035
110105-259	○ avorio/ivory ral1013	x1	80	440	585	490	2,70	mc. 0.035
110110-259	● cromato/chrome	x1	80	440	585	490	2,70	mc. 0.035

12 tappo 22 testa sferica nero
cap 22 spherical head black

code	finishing	q.kit
134203-224	● nero/black	x4

05 manila-scocca intera con braccioli
manila-plastic shell with arms

code	finishing	q.kit	q.pack	a	b	c	kg.x1	vol.x1
133904-045	● grigio/grey warm grey 6c	x1	5	390	580	480	2,60	mc. 0.05

06 manila-vite tc•combi 6x16 testa cilindrica a croce zincata (vite per fissaggio scocca)
manila-screw combi 6x16 cylindrical head cross zinc (screw for fix shell)

code	finishing	q.kit
117811-181	● zincata/zinc	x4

07 manila-pannello sedile multistrato con 6 borchie m6
manila-seat panel with 6 upholstery nail m6

code	finishing	q.kit	q.pack	kg.x1	vol.x1
122207-034	● faggio/plywood	x1	20	0,78	mc. 0.003

08 manila-vite tbi combi m6x12 zincata bianca (vite per fissaggio pannello)
manila-screw tbi combi m6x12 white zinc (screw for fix panel)

code	finishing	q.kit
117711-206	○ zincata bianca/white zinc	x6



for all colour codes, see page 297

manila

swivel



plastic colours

- rosso/red p1797u
- grigio/grey warm grey 6c
- avorio/ivory ral1013
- marrone/brown ral699
- giallo/yellow ral110u
- blu/blue ral5014

main component sizes

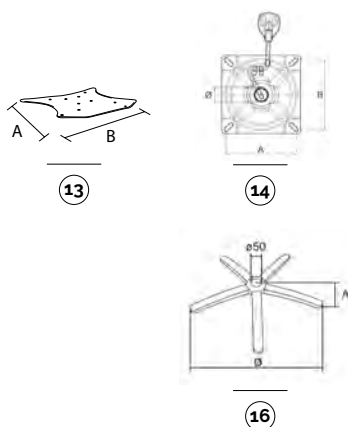

optionals

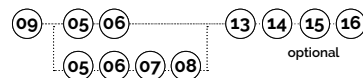
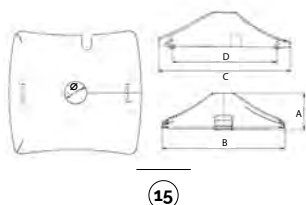

13 manila-telaio per girevole/panca manila-swivel/bench frame

code	finishing	q.kit	q.pack	a	b	kg.x1	vol.x1
110903-256	● nero/black	x1	10	265	325	2,00	mc. 0.0019
110904-256	● grigio/grey ig2621	x1	10	265	325	2,00	mc. 0.0019

14 pss28nr-piastra sgabello c/spat. c/28 3' l4 nera pss28nr- square metal plate with straight lever c/28 3' l4

code	finishing	q.kit	q.pack	a	b	ø	kg.x1	vol.x1
113003-104	● nero/black	x1	25	150	150	28	1,23	mc. 0.002

15 cpg-copertina in plastica per telaio girevole cpg-plastic cover for swivel frame

code	finishing	q.kit	q.pack	a	b	c	d	ø	kg.x1	vol.x1
130903-000	● nero/black	x1	50	60	200	210	167	36	0,1	mc. 0.0015

16 b40-base in metallo d.640 con coprisaldatura b40-metal base d.640 with cover welding

code	finishing	q.kit	q.pack	a	ø	kg.x1	vol.x1
110210-027	● cromato/chrome	x1	5	60	640	2,85	mc. 0.014

for the components below, see previous pages

05 06 07 08

CPG
plastic cover for swivel frame

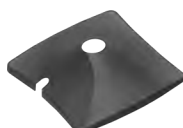

for all colour codes, see page 297

manila

bench



plastic colours

- rosso/red p1797u
- grigio/grey warm grey 6c
- avorio/ivory ral1013
- marrone/brown ral69g
- giallo/yellow ral110u
- blu/blue ral5014

main component sizes

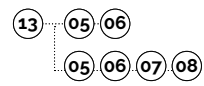
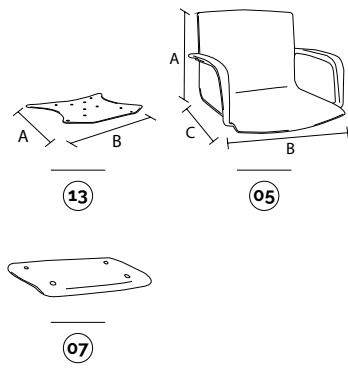

13 manila-telaio per girevole/panca
manila-swivel/bench frame

code	finishing	q.kit	q.pack	a	b	kg.x1	vol.x1
110903-256	● nero/black	x1	10	265	325	2,00	mc. 0,0019
110904-256	● grigio/grey ig2621	x1	10	265	325	2,00	mc. 0,0019

05 manila-scocca intera con braccioli
manila-plastic shell with arms

code	finishing	q.kit	q.pack	a	b	c	kg.x1	vol.x1
133904-045	● grigio/grey warm grey 6c	x1	5	390	580	480	2,60	mc. 0,05

06 manila-vite tc*combi 6x16 testa cilindrica a croce zincata (vite per fissaggio scocca)
manila-screw combi 6x16 cylindrical head cross zinc (screw for fix shell)

code	finishing	q.kit
117811-181	● zincata/zinc	x4

07 manila-pannello sedile multistrato con 6 borchie m6
manila-seat panel with 6 upholstery nail m6

code	finishing	q.kit	q.pack	kg.x1	vol.x1
122207-034	● faggio/plywood	x1	20	0,78	mc. 0,003

08 manila-vite tbi combi m6x12 zincata bianca (vite per fissaggio pannello)
manila-screw tbi combi m6x12 white zinc (screw for fix panel)

code	finishing	q.kit
117711-206	○ zincata bianca/white zinc	x6

for the components below, see previous pages

for all colour codes, see page 297

optionals

OPTIONAL
bench connector

E-USB
bench plug

JIM
bench leg

plastic

90GM bench leg

90GF bench leg

91GM NEW bench leg

100GM bench leg

200GM bench leg

PIONEER bench arm

metal

CUT bench leg

SLIM bench leg

CUT bench arm

SLIM bench arm

aluminium

manila

optional colour codes



shell colour codes



05 scocche in plastica
plastic shells

- 133902-045 rosso/red p1797u
- 133904-045 grigio/grey warm grey 6c
- 133905-045 avorio/ivory ral1013
- 133907-045 marrone/brown ral699
- 133908-045 giallo/yellow ral110u
- 133915-045 blu/blue ral5014

